

USER MANUAL

**NANLUX**

INNOVATE · ILLUMINATE

# *Dyno 650C/1200C*

*RGBWW LED SOFT PANEL LIGHT*

[WWW.NANLUX.COM](http://WWW.NANLUX.COM)

# Contents

<b>Product Diagram</b> .....	01	3. HSI Key .....	25
<b>Technical Data</b> .....	01	4. XY/RGBW Key .....	26
<b>Product Details</b> .....	02	5. GEL Key .....	28
<b>Detailed Description</b> .....	04	6. EFFECT Key .....	29
<b>Usage</b>		7. PRESET Key .....	51
1. Connection between Dyno 650C and Power Supply .....	05	8. MENU Key	
2. Connection between two Dyno 650C and Power Supply .....	06	① CCT LIGHTING MODE .....	56
3. Connection between Dyno 1200C and Power Supply .....	07	② ADDRESS/DMX .....	56
4. Light Stand Clamp Installation .....	08	③ LUMENRADIO SETTINGS .....	57
5. Diffuser Installation .....	09	④ FAN CONTROL .....	57
6. Barndoor Installation .....	10	⑤ ROTATE SCREEN .....	58
7. Hanging Options .....	11	⑥ SCREEN BRIGHTNESS .....	59
<b>Remote Control</b>		⑦ BUTTON BACKLIGHT .....	60
1. ADDRESS/DMX .....	12	⑧ LANGUAGE .....	61
2. DMX Remote Control .....	15	⑨ RESET ALL SETTINGS .....	63
3. 2.4G Remote Control .....	17	⑩ LOCK Key .....	63
4. RDM Remote Control .....	17	<b>Fan Exception Indication</b> .....	63
5. LUMENRADIO Remote Control .....	17	<b>Safety Precautions</b> .....	63
<b>Operating Instructions</b>		<b>Notice</b> .....	64
1. Screen Interface Display Instructions .....	23	<b>General Fault Detection and Diagnosis</b> .....	64
2. CCT Key .....	23	<b>Product Includes</b> .....	65

# Dyno 650C/Dyno 1200C RGBWW LED Soft Panel Light

## Product Diagram

### Technical Data

**Model No: Dyno 650C**

Rated power: 650W

Input voltage/current: DC48V/14.6A Max

AC100-240V 50/60Hz

CCT: 2700K-20000K

CRI: Average 95

TLCI: Average 95

**Model No: Dyno 1200C**

Rated power: 1200W

Input voltage/current: DC48V/29.2A Max

AC100-240V 50/60Hz

CCT: 2700K-20000K

CRI: Average 95

TLCI: Average 95

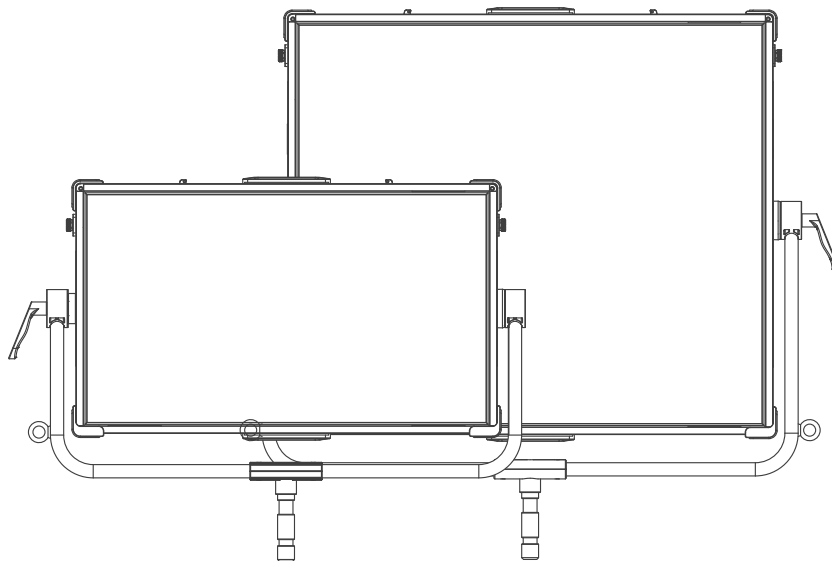
*Dyno 650C**Dyno 1200C*

**Product Details**

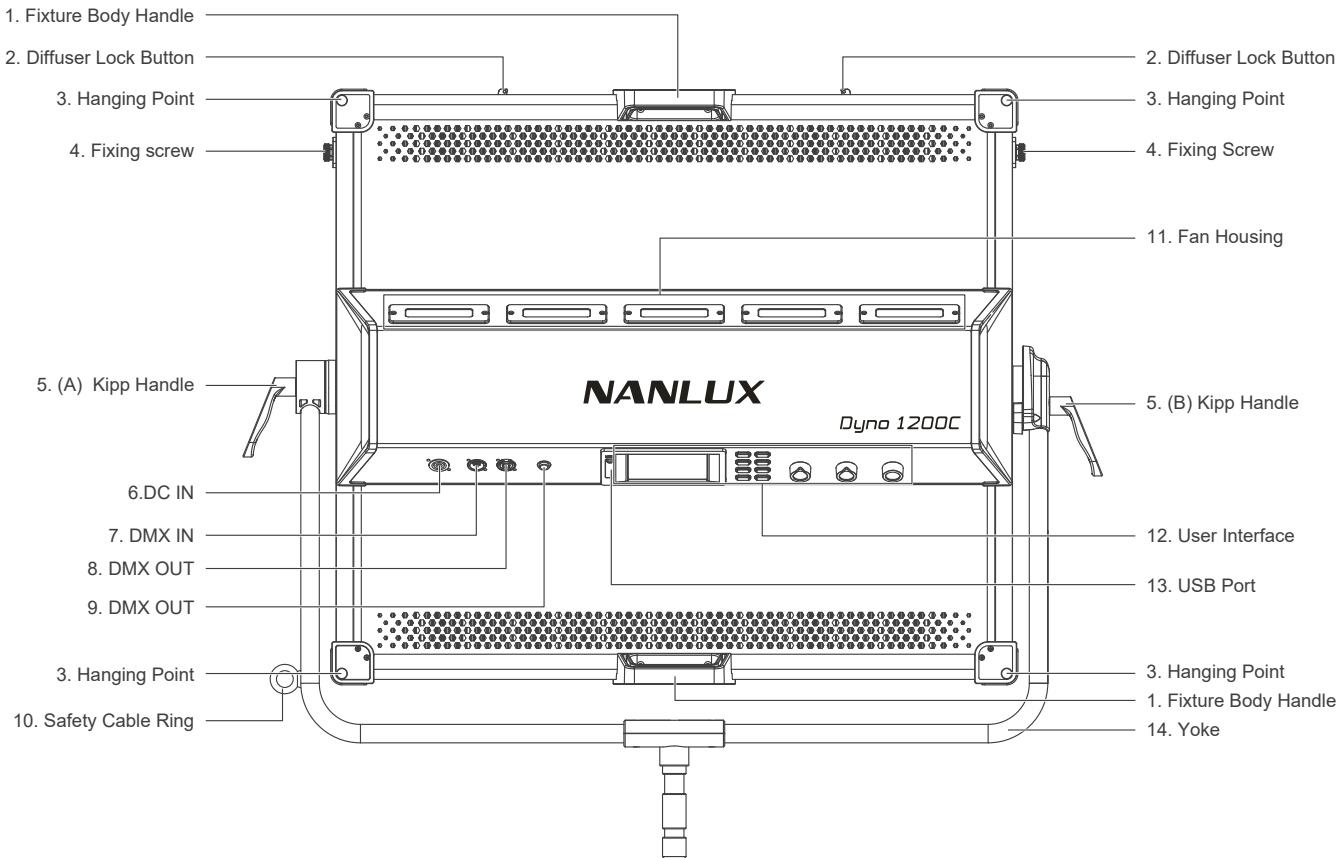

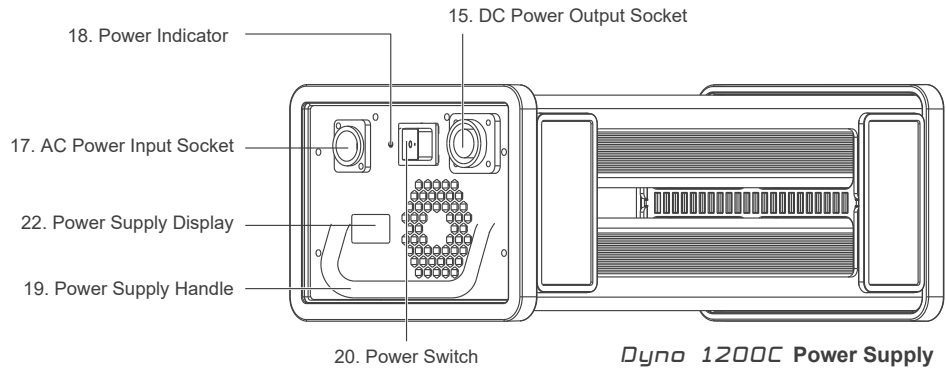
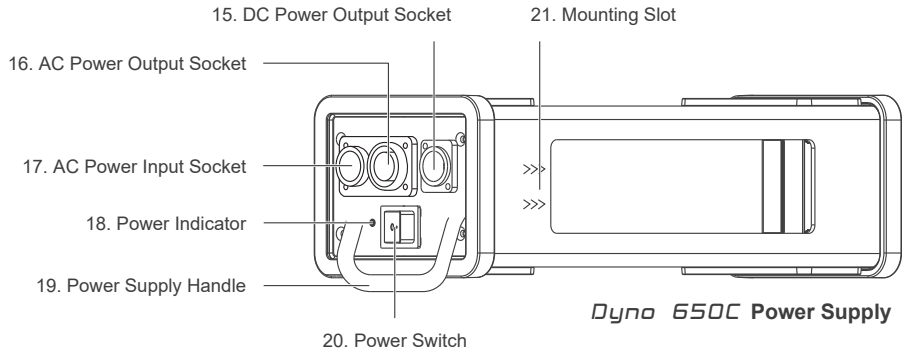

## Product Description

1. Fixture body handle: Adjust the direction of the fixture.
2. Diffuser lock button: Release or secure the diffuser to the fixture.
3. Hanging point: Mount fixture in hanging configuration.
4. Fixing screw: Lock and fix the diffuser.
5. Kipp handle: Tighten or release the tilt movement of the fixture on the yoke.  
(Dyno 1200C has a Kipp handle on each side of the yoke. Dyno 650C just has a single Kipp handle on the left side.)
6. DC IN: DC power input interface.
7. DMX IN: DMX signal input interface.
8. DMX OUT: DMX signal output interface.
9. CONTROL: Wired Remote port.
10. Safety cable ring: Attach safety rope to secure the diffuser.
11. Fan housing: Installing or removing the fan.
12. User interface: Display and control functions, operations and data.
13. USB port: Install firmware updates.
14. Yoke: Mount the fixture on a stand, pan and tilt.
15. DC power output socket: Connect the DC power cable.
16. AC power output socket: For connecting to one more power supplier of the Dyno 650C or other fixture of maximum current 15A.  
(Note: The Dyno 1200C do not have this socket due to power limitation.)
17. AC power input socket: For connecting the AC power cable to supply power the adapter.
18. Power indicator: Check the status of the power input. Indicator always on: normal power supply; Indicator flashing or off: abnormal power supply or no power input.
19. Power supply handle: For lift the power supply.
20. Power switch: Turn fixture on/off.
21. Mounting slot: Fix the power adapter to the lighting stand clamp.
22. Power supply display: Voltage and fan status of Dyno 1200C power supply.

## Usage

1. Connection between Dyno 650C and Power Supply.

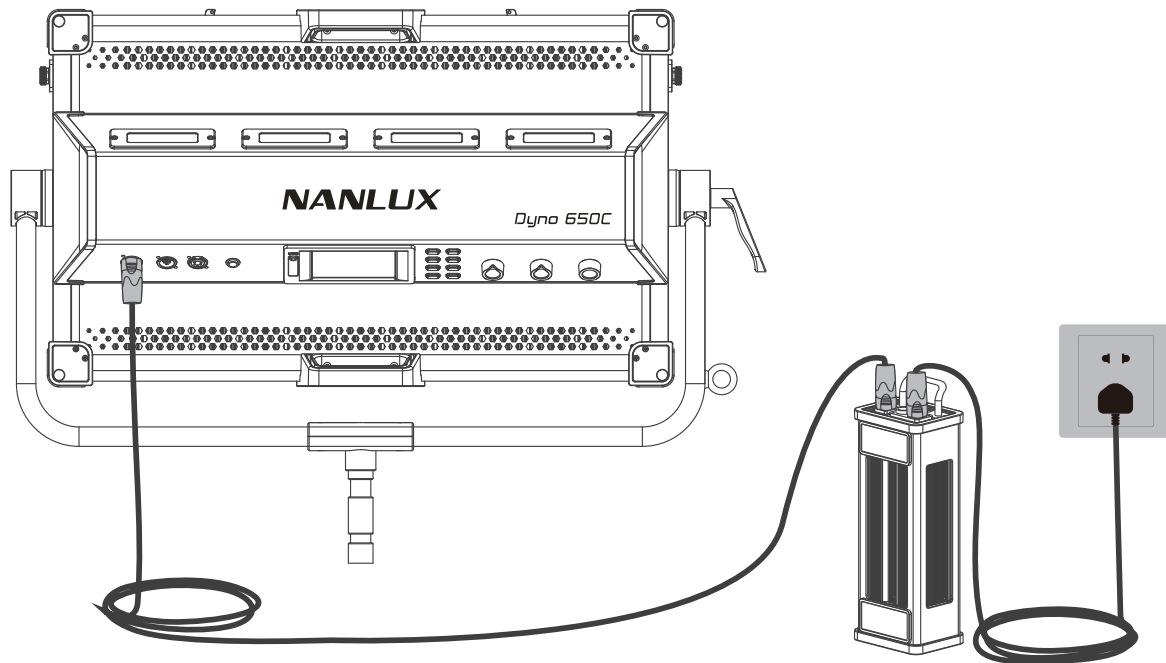

2. Connection between two Dyno 650C and Power Supply.

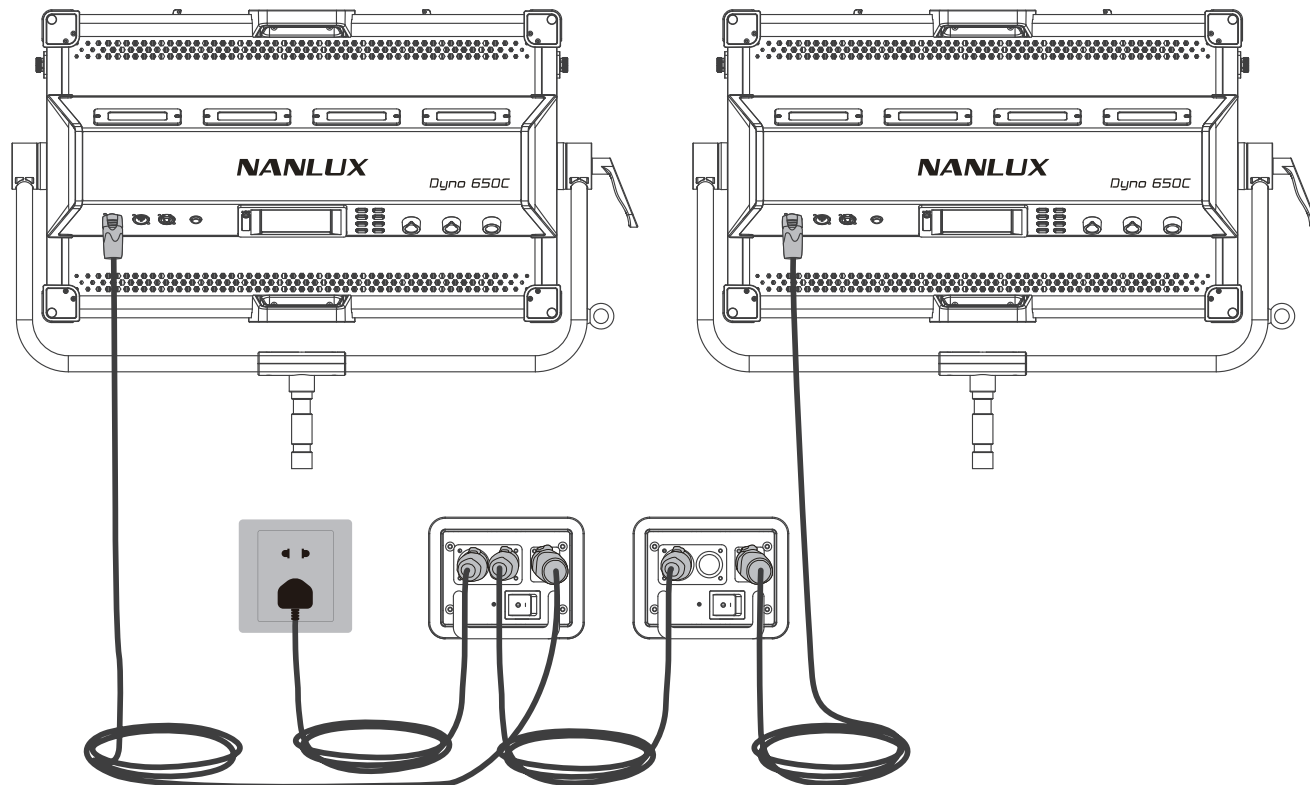



3. Connection between Dyno 1200C and Power Supply.

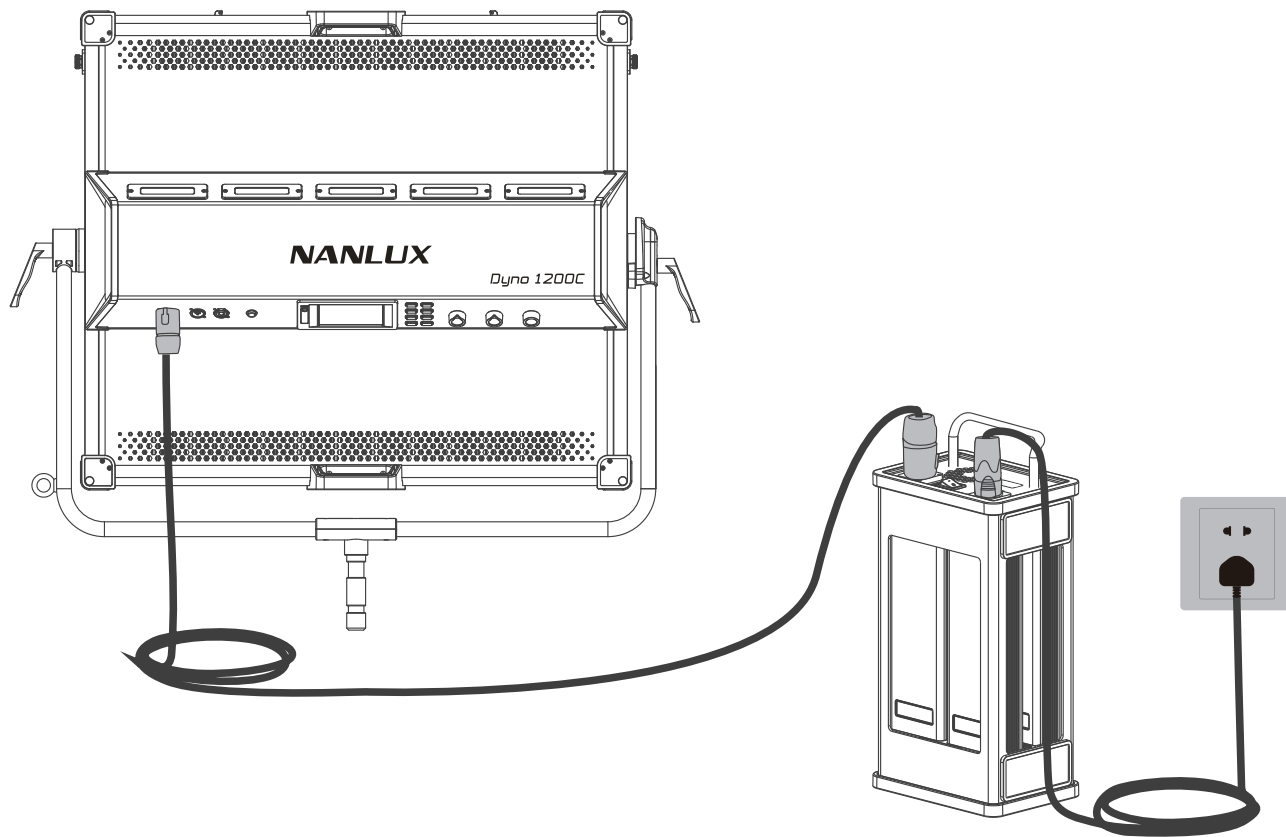

NOTE: ① When connecting the power supply, please make sure the power, voltage and frequency are consistent with the provided power supply.

② Make sure to use the provided power supply and power cable. The connection between the DC power output socket on power supply and the power cable should be connected as following.

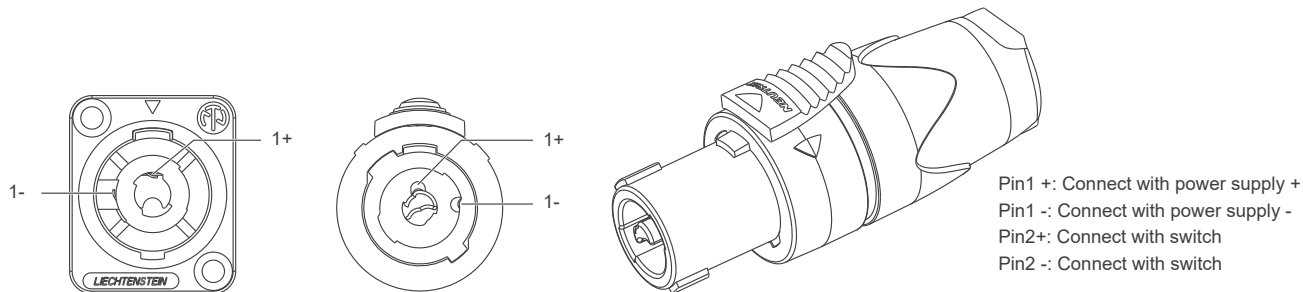

#### 4. Light Stand Clamp Installation

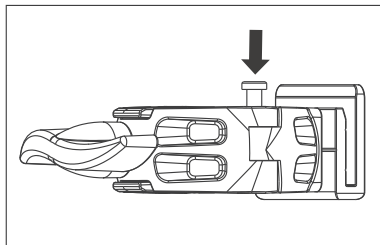

Push the button to open the clamp.

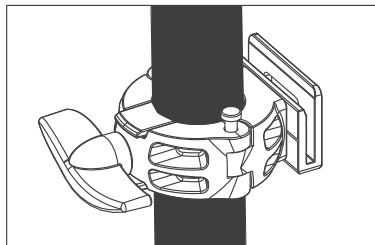

Place the clamp on the light stand and rotate the fixing screw into the locking direction to secure the lamp on to the stand.

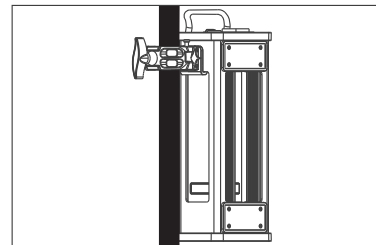

Attach the power supply to the mounting slot.

5. Diffuser Installation

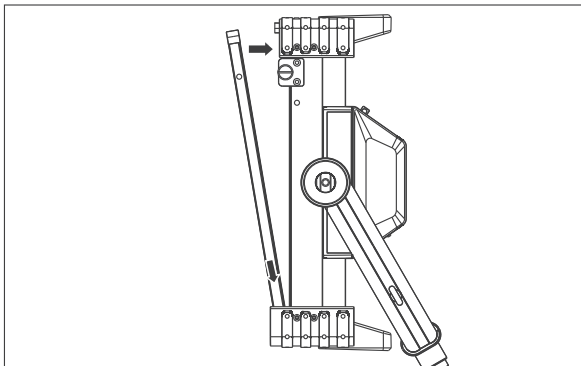

Align the diffuser with the slot on the front of the fixture.

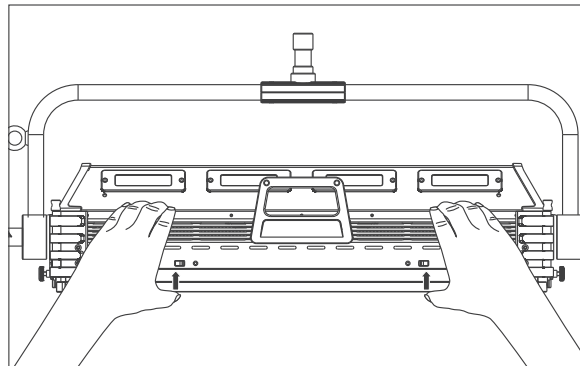

Insert the diffuser into the slots along the lower edge of the fixture and push the upper part of the diffuser into place.

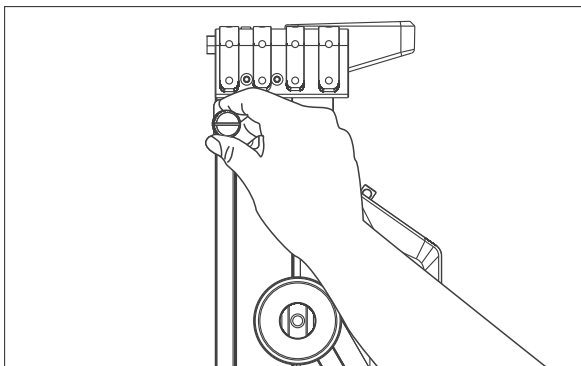

Use the screws on both sides and secure the diffuser in place. Loosen the fastening screws on both sides before removing the diffuser.

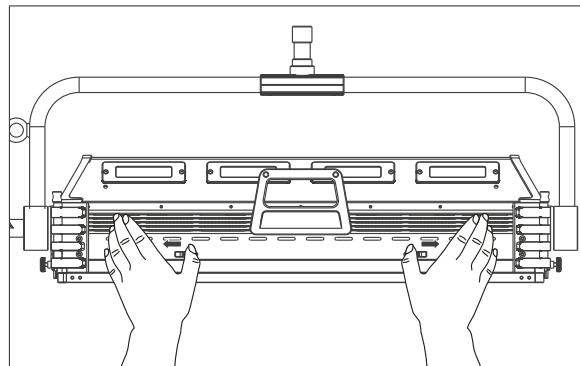

Toggle the lock catch according to the direction indicated by the lock on the fixture, the diffuser will pop up to allow removal from the fixture.

6. Barndoor Installation

NOTE: Barndoor is sold separately.

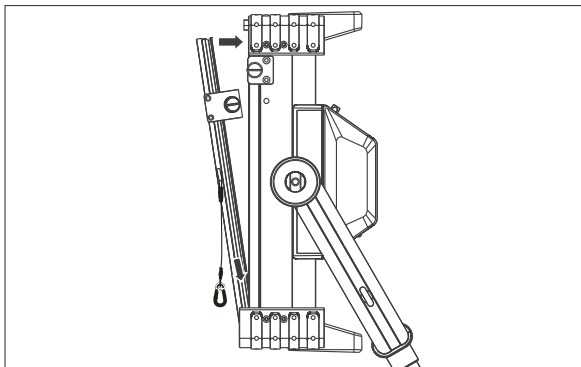

Align the barndoor with the slot on the front of the fixture.

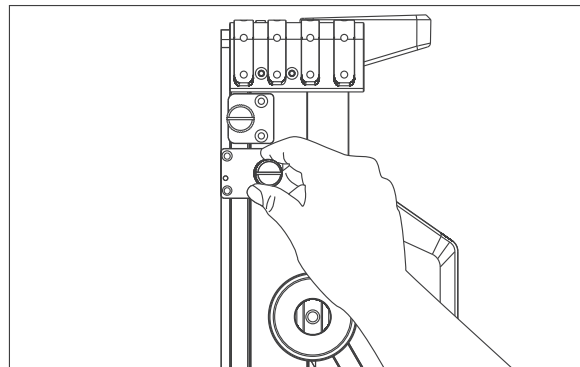

Rotate the screws on both sides then attach the barndoor to the light fixture.

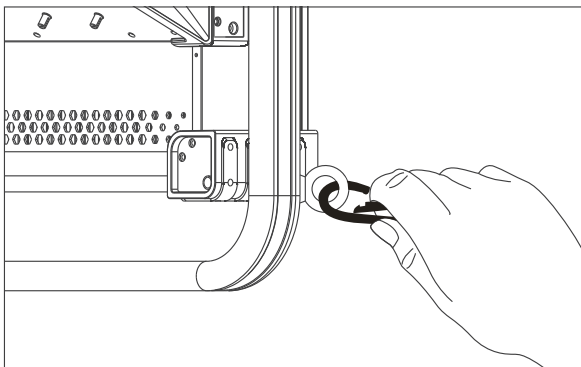

Attach the safety rope on the safety cable ring on the fixture.

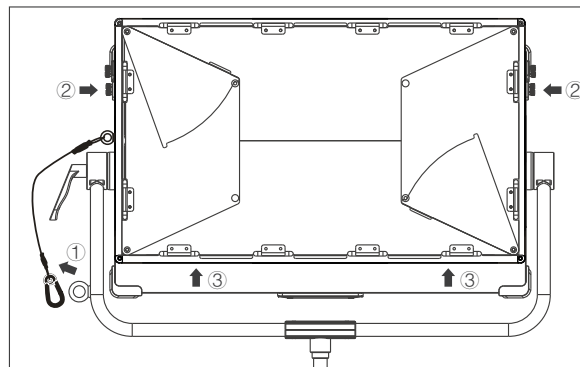

When removing the barndoor, first remove the safety rope, then loosen the screws on both sides and remove the barndoor from the fixture.

7. Hanging Options

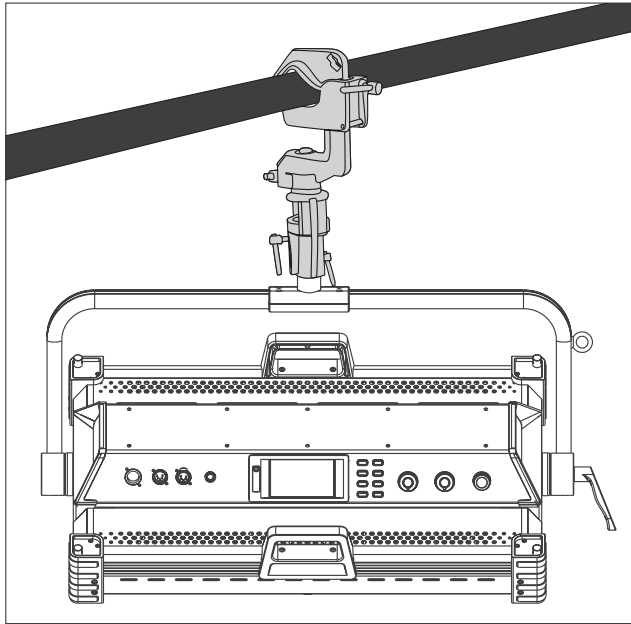

Using the yoke.

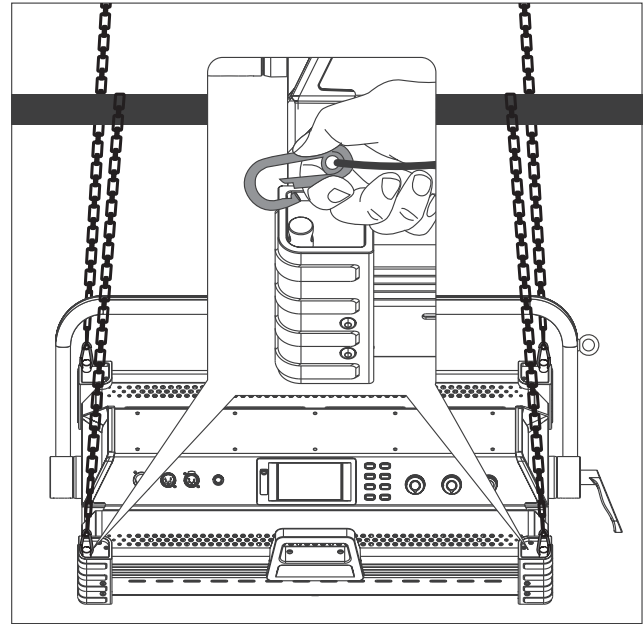

Using the rigging points.

- NOTE: Always ensure that all rigging points are securely attached when hanging fixtures.

# Remote Control

· Dyno 650C/Dyno 1200C supports remote control via DMX, 2.4G, RDM and LUMENRADIO, and has built-in bluetooth.

▲ The ADDRESS needs to be set before operating the remote control via DMX, 2.4G, RDM and LUMENRADIO.

1. ADDRESS/DMX, including ADDRESS, DMX MODE and DMX DIMMING CURVE settings.

## ① ADDRESS

Press MENU key to access options.

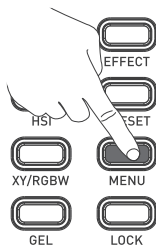
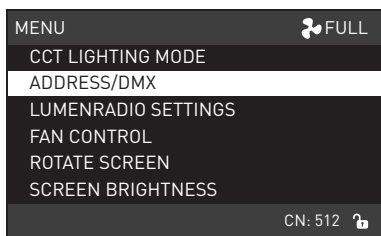

(Left knob)



(Middle knob)



(SELECT knob)

SELECT

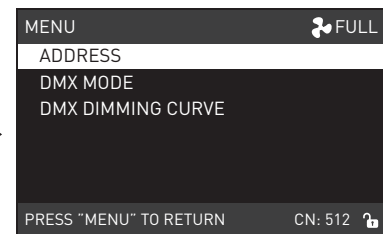
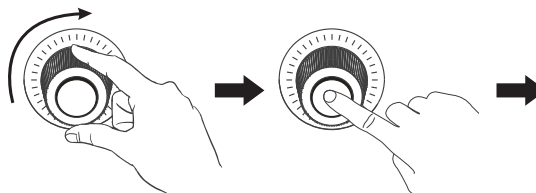
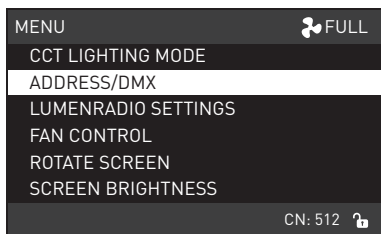

Rotate "SELECT knob" to ADDRESS/DMX, press "SELECT knob" to enter the corresponding secondary menu.

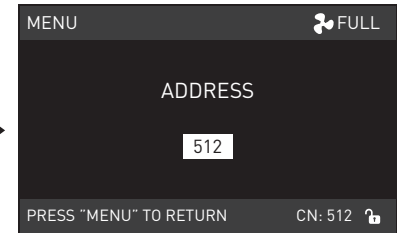
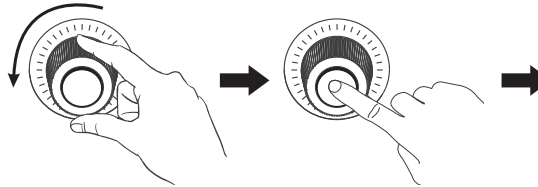
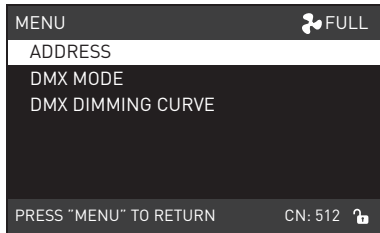

Rotate "SELECT knob" to ADDRESS, press "SELECT knob" to enter corresponding third menu.

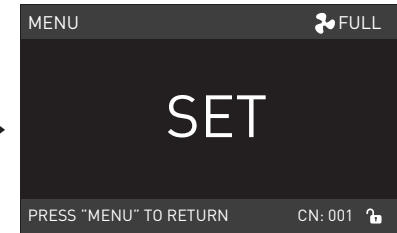
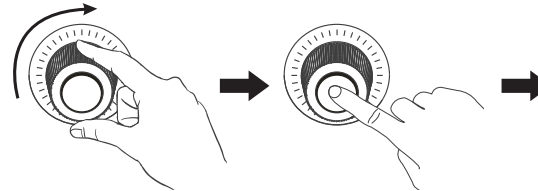
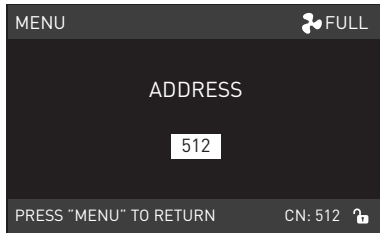

Rotate "SELECT knob" to select the desired ADDRESS number and press the "SELECT knob" to set.

NOTE: Dyno 650C/Dyno 1200C has 22 channels, for multiple lights remote control via DMX, 2.4G, RDM, LUMENRADIO, the address of the first light is set to 001, the second one is 012, the third one is 023 and so on.

② DMX MODE

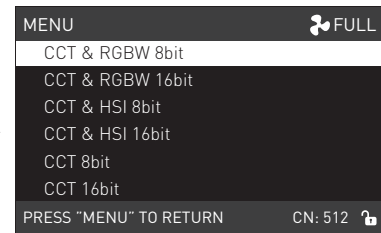
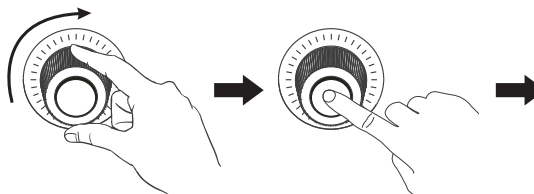
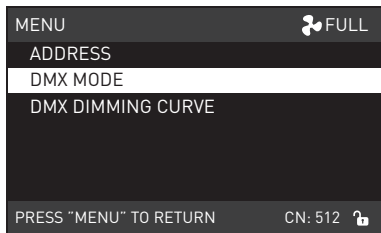

Rotate "SELECT knob" to DMX MODE and press "SELECT knob" to enter the corresponding third menu.

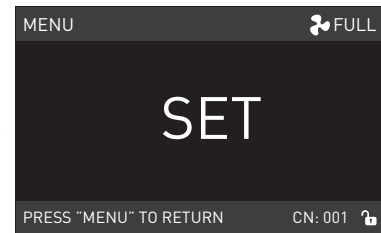
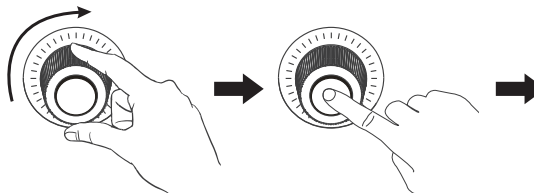
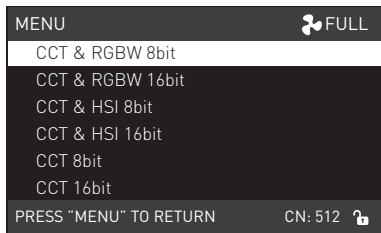

Rotate "SELECT knob" to select the corresponding DMX mode and press "SELECT knob" to set.



③ DMX DIMMING CURVE

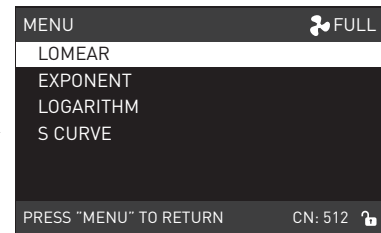
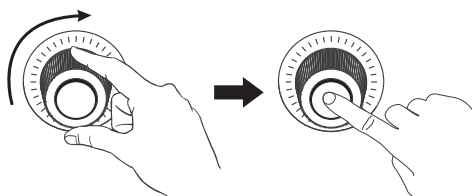
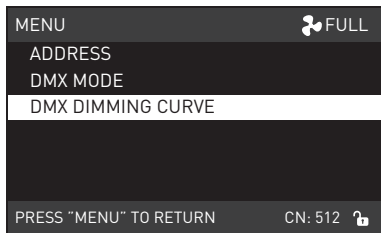

Rotate "SELECT knob" to DMX DIMMING CURVE and press "SELECT knob" to enter the corresponding third menu.

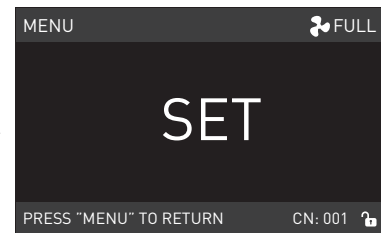
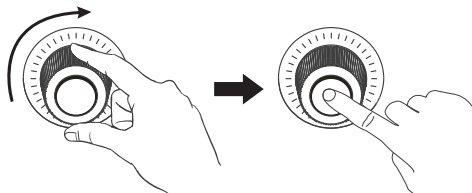
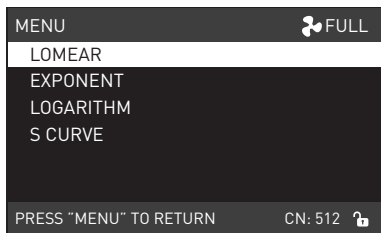

Rotate "SELECT knob" to select the corresponding DMX dimming curve and press "SELECT knob" to set.

2. DMX Remote Control

① Connect the light fixture and the DMX512 console by connection cable and the method is as below.



- The connection between the light fixture and DMX512 console, light fixture and light fixture should use five core shielded cable and make sure its diameter is not less than 0.3mm. XLR plug/socket and the wire should be connected as the picture aboved.
- Pin1, Pin2, Pin3 for connecting DMX signal, Pin4, Pin5 is connectionless.
- ▲ NOTE: When connect with socket, make sure the internal pin not be in contact with the inner case.The fixture can match the DMX512 (1990) control signal.
- Plug of five-core and three-core XLR plug/socket conversion.  
The fixture comes with five-core XLR plug. If you use the three-core XLR plug, kindly follow below instruction.

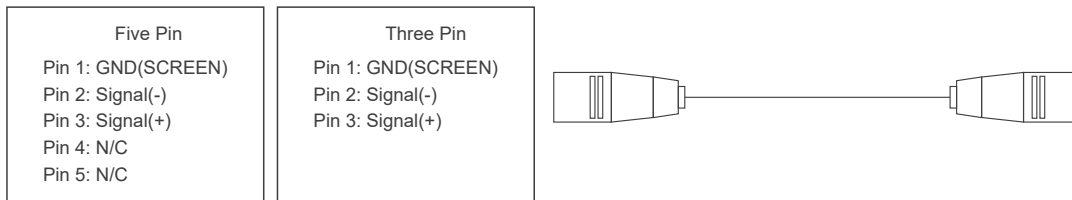

② DMX-in Port

In DMX mode, make sure the last light is the only light with cable conected to DMX output. There is a resistance of about 120(OHm) between the second pin and third pin of this plug (as below photo). Make sure this plug is installed into the output interface of the last fixture which can avoid noise and reflection phenomenon caused by DMX signal in the transmitting process.

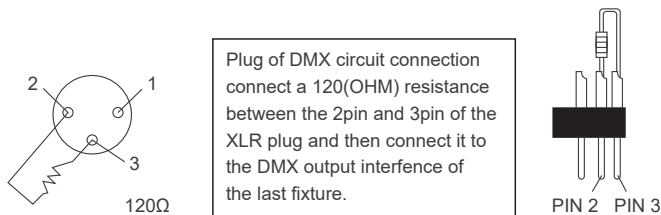

③ Set the address of the fixture.

④ Refer to the attached DMX channel list and control the light via DMX512 console.

(For specific operation methods, please refer to the DMX512 console operation manual.)

Note: DMX channel list «Dyno 650C/Dyno 1200C DMX REFERENCE GUIDE» please download it from [www.nanlux.com](http://www.nanlux.com).

### 3. 2.4G Remote Control

Set the address of the 2.4G remote controller to be consistent with the light fixture, enabling the Dyno 650C/1200C to be remotely controlled by 2.4G remote controller or by Wi-Fi APP via the 2.4G transfer device.

Note: 2.4G remote controller and 2.4G transfer device are sold separately.

(See separate instructions for remote controller or 2.4G transfer device.)

### 4. RDM Remote Control

① Connect the light fixture to the console with RDM function using a 5-pin XLR connection cable, the connection method is the same as with a DMX512 console.

② Control the fixture via a console with RDM function. (For specific operation methods, please refer to the RDM console operation manual.)

Note: The UID format of the fixture is as follows:

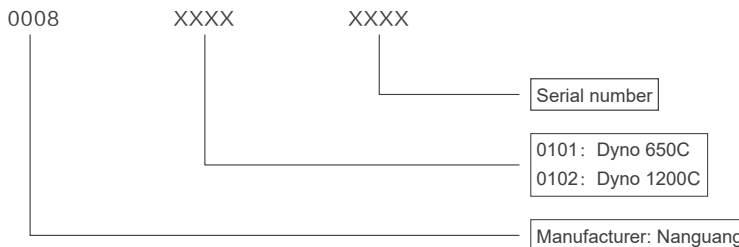

### 5. LUMENRADIO Remote Control

· Dyno series has built-in CRMX TIMO TWO module, enabling it to receive or transmit CRMX wireless DMX signals.

#### ① RECEIVER MODE

##### (1) RECEIVER MODE setting

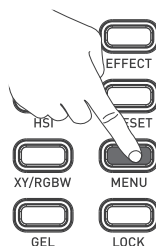
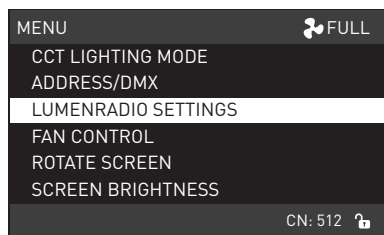

(Left knob)



(Middle knob)

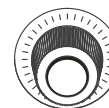

(SELECT knob)

SELECT

Press the MENU key to access options.

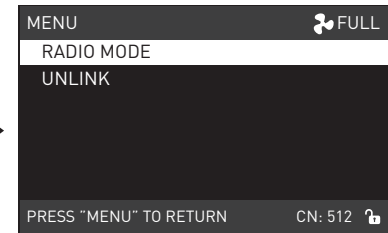
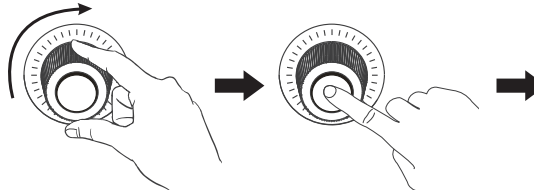
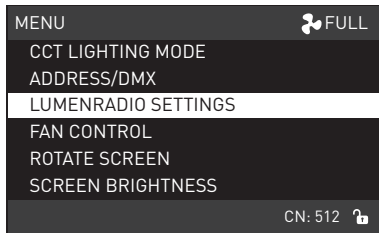

Rotate "SELECT knob" to LUMENRADIO SETTINGS and press "SELECT knob" to enter the corresponding secondary menu.

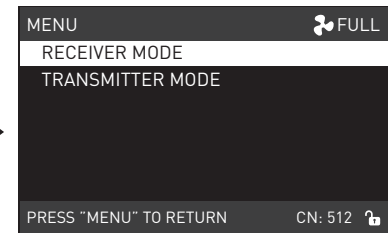
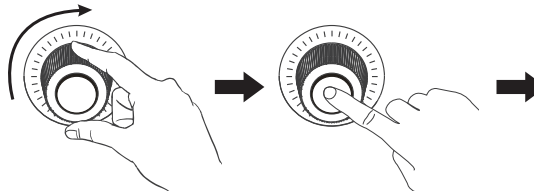
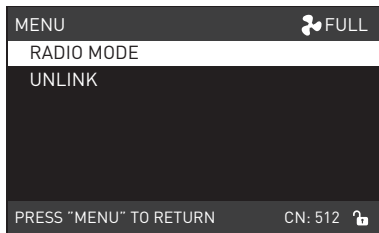

Rotate "SELECT knob" to RADIO MODE and press "SELECT knob" to enter next menu.

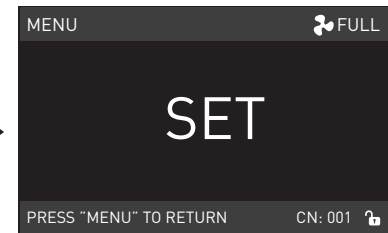
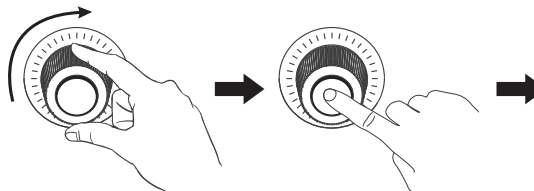
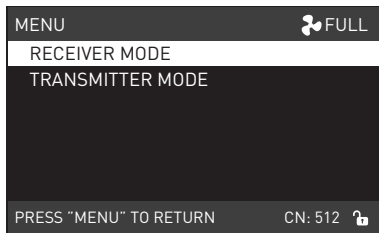

Rotate "SELECT knob" to select RECEIVER MODE and press "SELECT knob" to set.

(2) UNLINK Setting

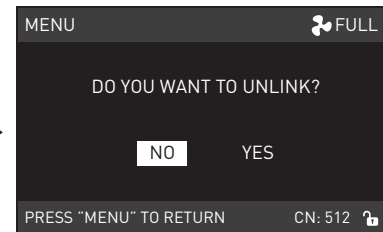
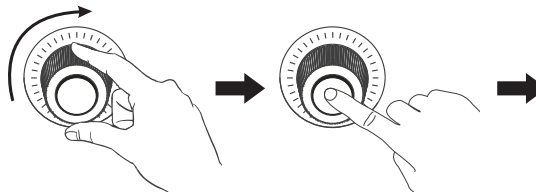
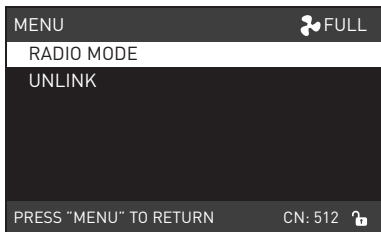

Rotate "SELECT knob" to UNLINK and press "SELECT knob" to enter next menu.

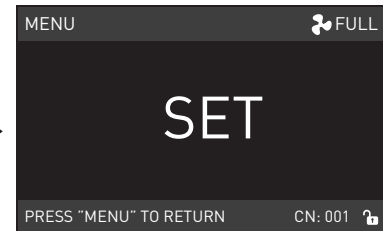
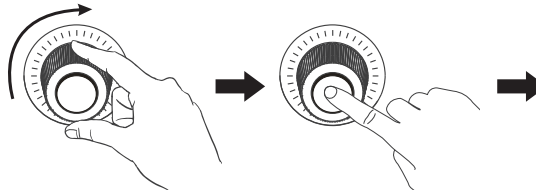
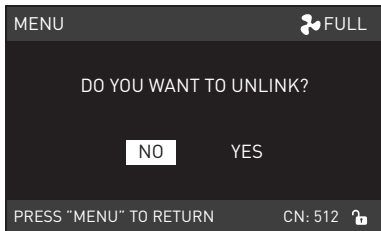

Rotate "SELECT knob" to select "YES" and press "SELECT knob" to set.

(3) Please refer to P22 of the manual or CRMX wireless DMX transmitter manual to connect the Dyno or CRMX wireless DMX transmitter set to TRANSMITTER MODE with the fixture set to RECEIVER MODE, the the fixture can receive CRMX wireless DMX signals for remote control.

Note: · CRMX wireless DMX transmitter is sold separately.

· In RECEIVER MODE, the LUMENRADIO SETTINGS should be set to UNLINK then it could be reconnected to the new Dyno fixtures or transmitters.

②. TRANSMITTER MODE

(1) Set the RADIO MODE of the fixture to TRANSMITTER MODE and connect with the DMX512 console.

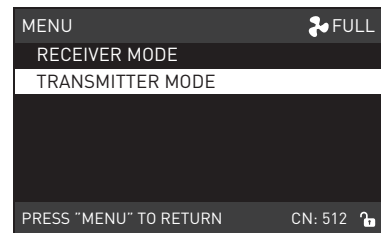
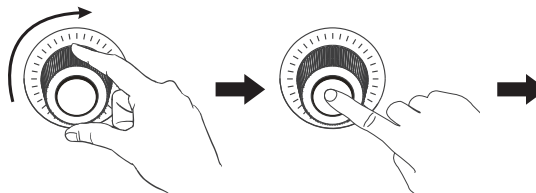
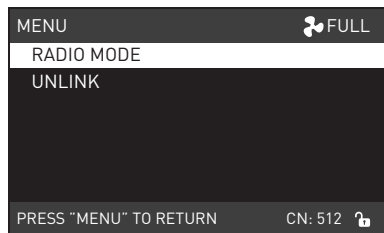

Rotate "SELECT knob" to RADIO MODE and press "SELECT knob" to enter next menu.

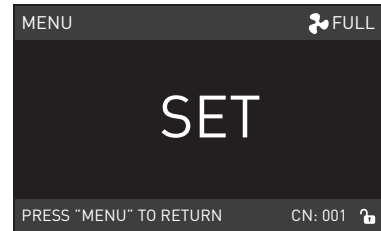
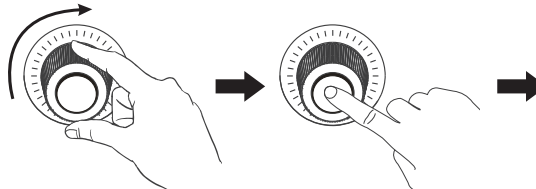
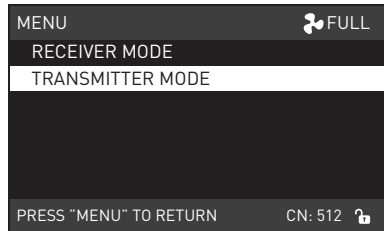

Rotate "SELECT knob" to select TRANSMITTER MODE and press "SELECT knob" to set.

(2) The light can set the RF OUTPUT POWER under the TRANSMITTER MODE. The setting methods is as below:

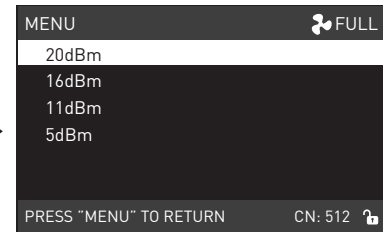
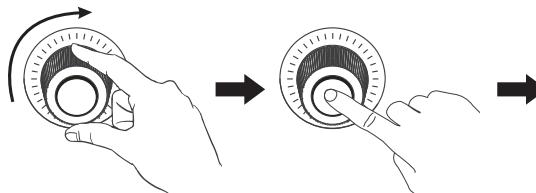
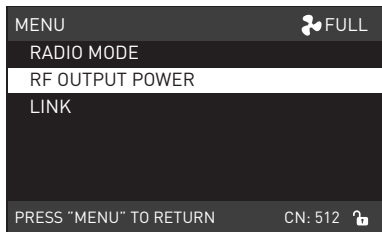

Rotate "SELECT knob" to OUTPUT POWER and press "SELECT knob" to enter the next menu.

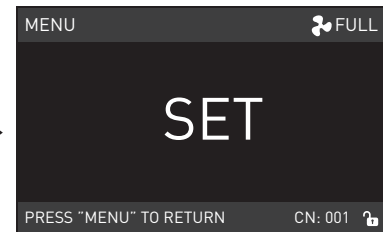
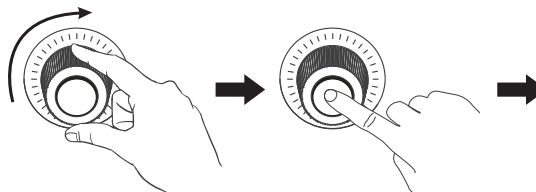
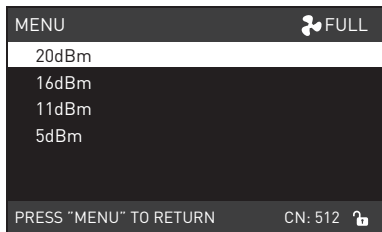

Rotate "SELECT knob" to select the desired RF OUTPUT POWER and press "SELECT knob" to set.

(3) Set other fixtures that need to receive CRMX wireless DMX signals to RECEIVER MODE and set to UNLINK. (For setting method, please refer to P17.)

(4) Connect the fixture set in TRANSMITTER MODE with the fixture set in RECEIVER MODE, then the LUMENRADIO wireless signal can be sent to the fixture set to RECEIVER MODE.

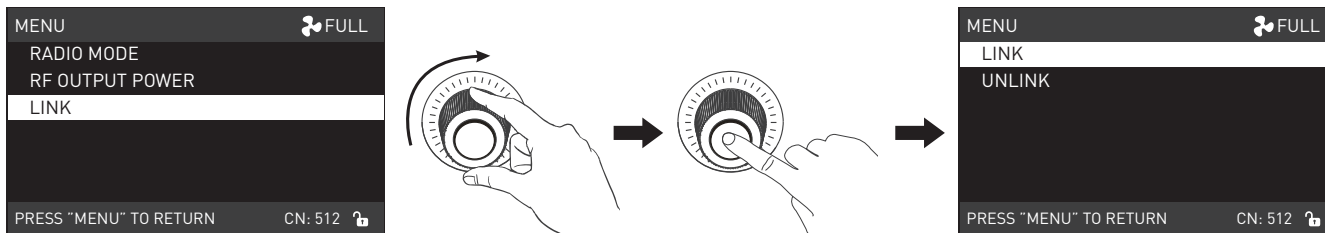

Rotate "SELECT knob" to LINK and press "SELECT knob" to enter the next menu.

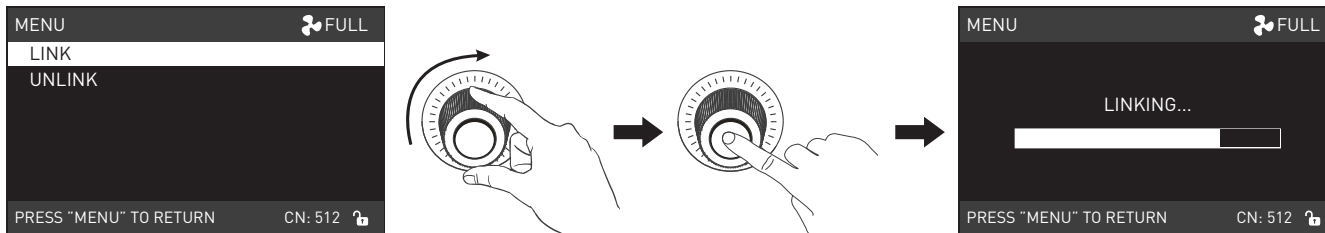

Rotate "SELECT knob" to select LINK and press "SELECT knob" to set.

(5) UNLINK Setting

When the fixture needs to stop transmitting the CRM e fixture to UNLINK. The setting method is the same as the P19.



# Operation Instructions

1. Make sure the power switch on the fixture is in the off position, then connect the fixture to the adapter with power cable. When turned on, the screen will first display "NANLUX", that means the power is active.

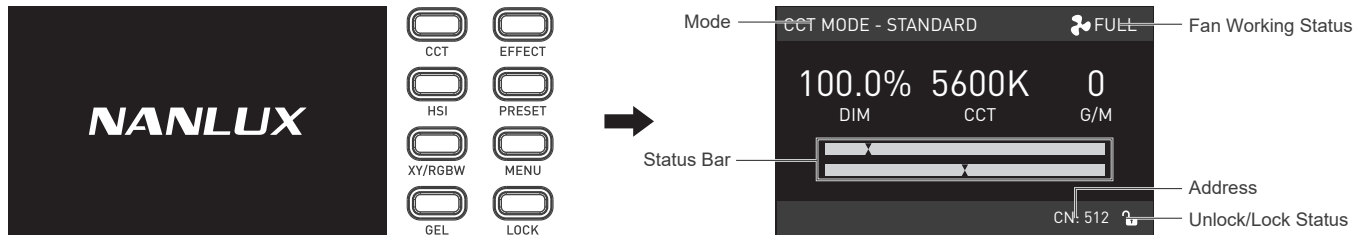

2. CCT Key: Press the CCT key to enter the operation interface of the CCT mode. CCT mode has two modes: Standard mode and Boost mode. (See the menu instruction for detail of switching two modes.)

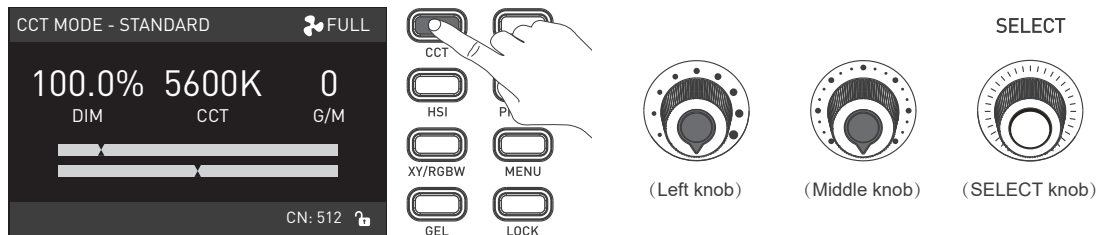

- ① Brightness setting, rotate "DIM knob", clockwise to increase brightness while counterclockwise to reduce brightness, brightness shows the percentage of brightness on the display, the brightness range is from 0.0%-100.0%.

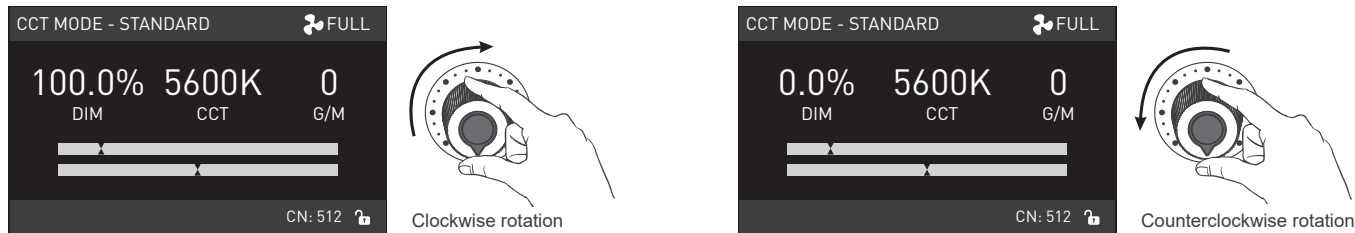

Note: In other modes, the brightness adjustment range is the same as in CCT mode. When the fixture function is unlock, in any mode, press the "DIM knob", the light is off, the brightness percentage on the display is 0.0% , press again, the fixture restores the previous status, press continuously to switch brightness between on and off.

- ② CCT setting, rotate "middle knob", clockwise to increase the value of CCT while counterclockwise to reduce the value of CCT, the screen displays the value of CCT and the corresponding CCT status bar.

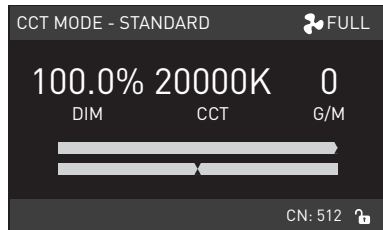

Clockwise rotation

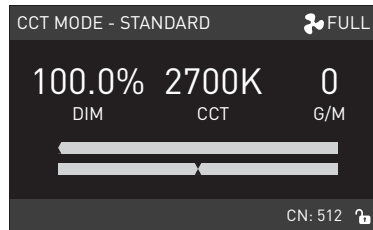

Counterclockwise rotation

Notes: (1) In standard mode, the CCT adjustment range is 2700K-20000K, press "middle knob" to quickly adjust the color temperature in sequence: 2700K, 3200K, 4300K, 5600K, 6500K, 7500K, 8500K, 10000K, 12000K, 14000K, 16000K, 18000K, 20000K, press continuously to adjust circularly.

(2) In boost mode, the CCT adjustment range is 2700K-7500K, press "middle knob" to quickly adjust the color temperature in sequence: 2700K, 3200K, 4300K, 5600K, 6500K, 7500K, press continuously to adjust circularly.

- ③ G/M setting, rotate "SELECT knob", clockwise to increase the value of G/M while counterclockwise to reduce the value of G/M, the screen displays the value of G/M and the corresponding G/M status bar. The G/M range is from -100 to +100.

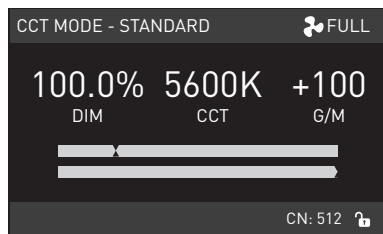

Clockwise rotation

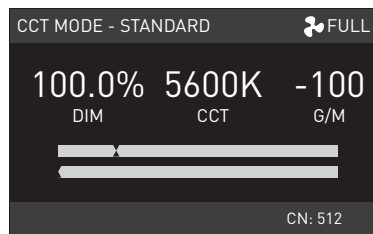

Counterclockwise rotation

Notes: (1) In other modes, G/M adjustment range is the same as in CCT mode.

(2) In CCT mode, press "SELECT knob" to reset its G/M value to 0.

3. HSI Key: Press HSI Key to enter the operation interface of HSI mode.

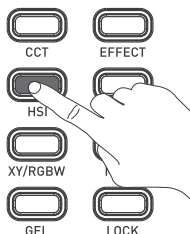
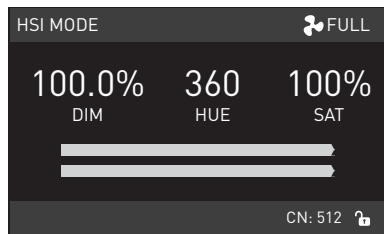

(Left knob)



(Middle knob)



(SELECT knob)

SELECT

① HSI setting, rotate "middle knob", clockwise to increase the value of HSI while counterclockwise to reduce the value of HSI, the screen displays the value of HSI and the corresponding HSI status bar. The HSI range is from 000---360, continuously rotate to adjust circularly.

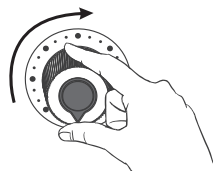
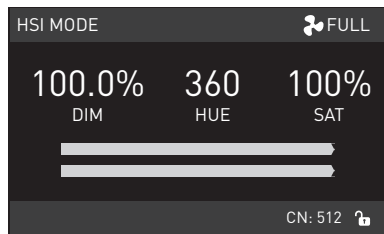

Clockwise rotation

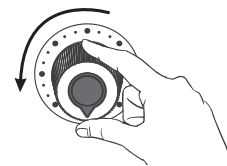
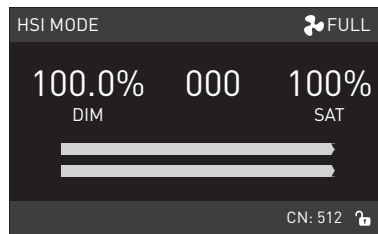

Counterclockwise rotation

Note: (1) In other modes, the HSI range is the same as in HSI mode.

(2) In HSI mode, rotate "middle knob" to quickly and circularly adjust HSI: 060, 120, 180, 240, 300, 360.

② SAT setting, rotate SELECT, clockwise to increase the value of SAT while counterclockwise to reduce the value of SAT, the screen displays the value of SAT and the corresponding SAT status bar. The SAT adjustment range is 0%--100%. Note: In other modes, the SAT range is the same as in HSI mode.

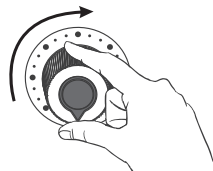
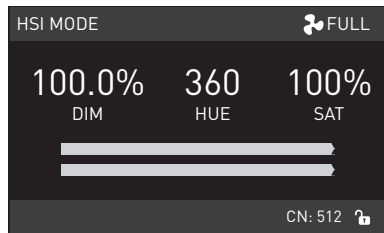

Clockwise rotation

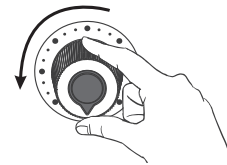
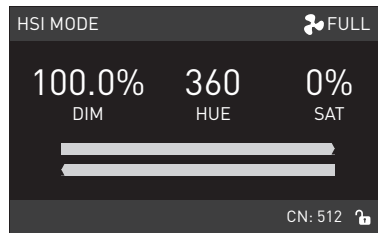

Counterclockwise rotation

4. XY / RGBW Key: Press XY/RGBW key to defaultly enter the operation interface of XY mode. Press again to switch to the operation interface of RGBW mode.

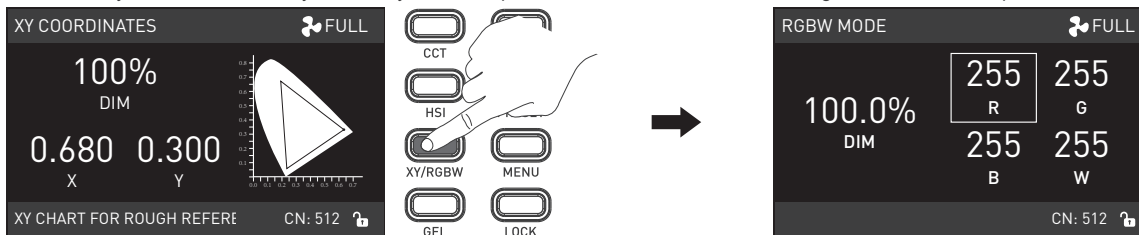

① In XY mode, rotate “ Middle knob” to adjust the value of X coordinate while rotate "SELECT knob" to adjust the value of Y coordinate. The fixture can output the lights of the corresponding color in CIE1931 chromaticity coordinate diagram by adjusting the values of XY coordinates.

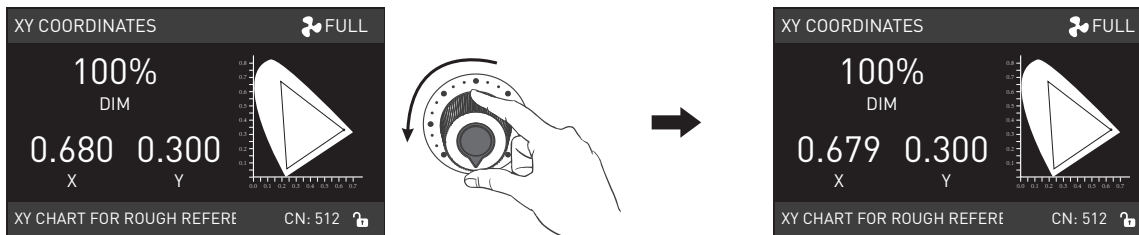

② In R, G, B, W "SELECT knob" to select R, G, B or W, then rotate "middle knob" to adjust the numerical proportion of R, G, B, W to color mixing. The adjustment range of RED, BLUE, GREEN, WHITE is from 0-255.

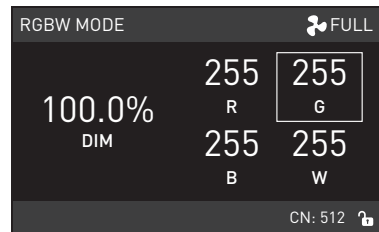
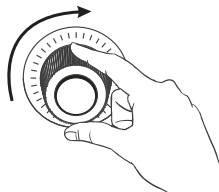
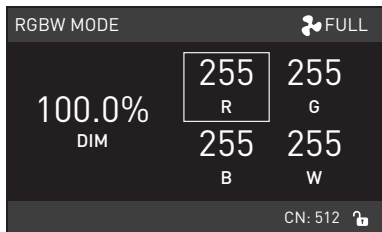

Rotate "SELECT knob" to select R, G, B or W.

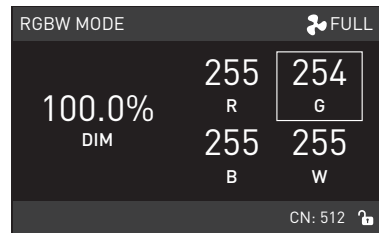
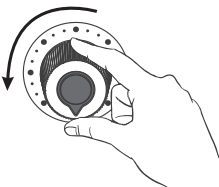
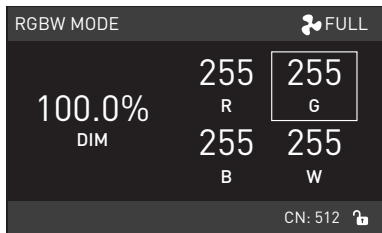

Rotate "middle knob" to adjust the numerical proportion of R, G, B, W to color mixing.

5. GEL Key: Press the GEL key to enter the operation interface of GEL mode.

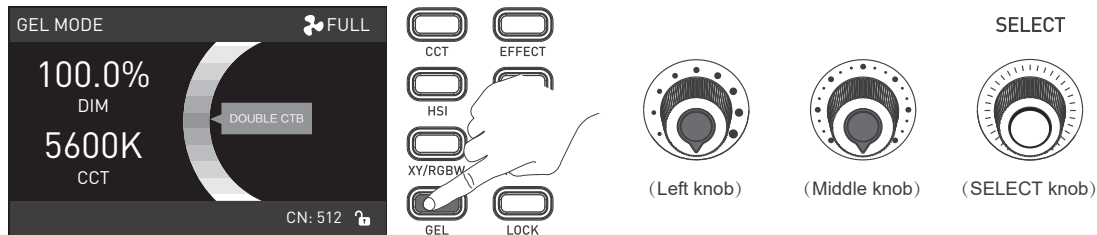

① CCT Setting: Rotate or press "middle knob" to select the value of CCT as 3200K or 5600K.

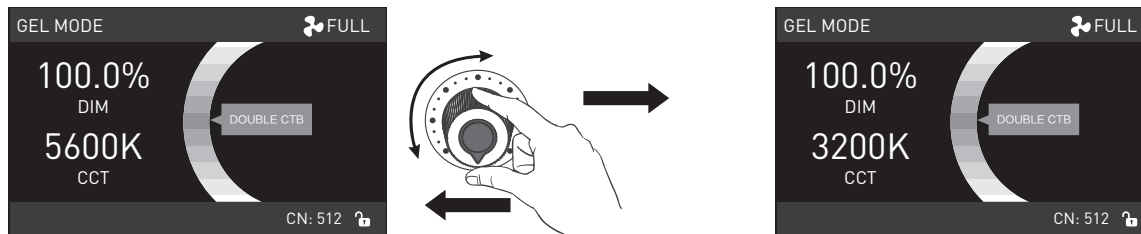

Rotate or press "middle knob" to select the value of CCT as 3200K or 5600K.

② GEL Setting: Rotate "SELECT knob" to select the GEL.

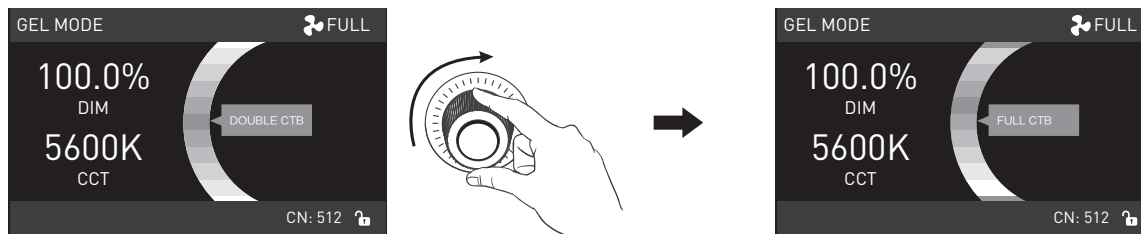

Rotate "SELECT knob" to select the GEL.

6. EFFECT Key: Press EFFECT key to enter the operation interface of EFFECT MODE.

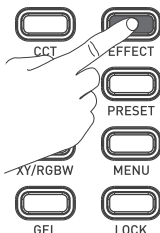
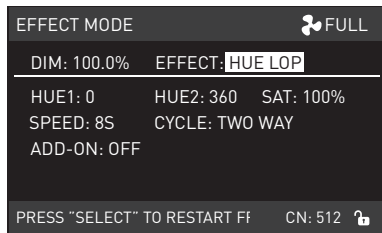

(Left knob)



(Middle knob)

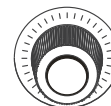

(SELECT knob)

SELECT

Dyno 650C and Dyno 1200C has built-in special effects: HUE LOOP, CCT LOOP, INT LOOP, FLASH, PULSE, STORM, POLICE CAR, TV, PAPARAZZI, CANDLE/FIRE, DISCO, BAD BULB, FIREWORK, EXPLOSION, WELDING.

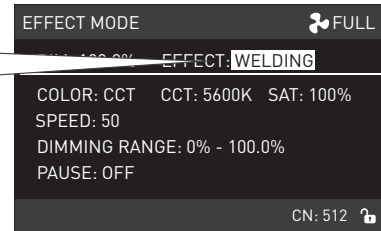
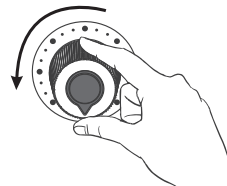
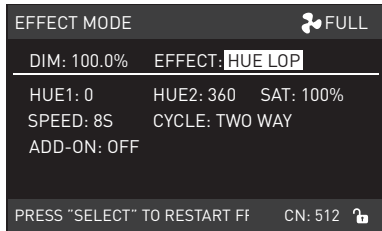

Rotate "middle knob" to select the desired special effect and the special effects can be adjusted circularly.

① HUE LOOP

HUE LOOP setting: Rotate "SELECT knob" to select HUE1, HUE2, SAT, SPEED (Range: 2S-30S), CYCLE, ADD-ON, then rotate "middle knob" to set the parameters of the corresponding options.

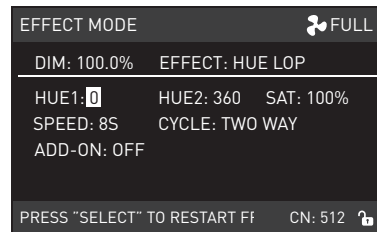
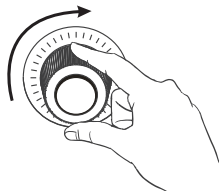
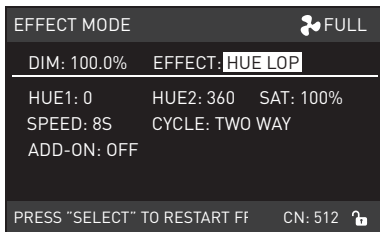

Rotate "SELECT knob" to select HUE1, HUE2, SAT, SPEED, CYCLE, ADD-ON.

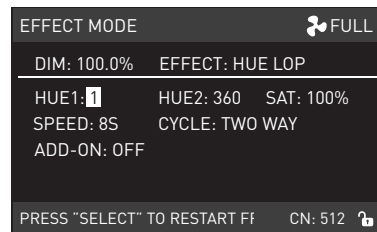
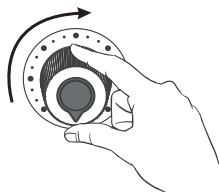
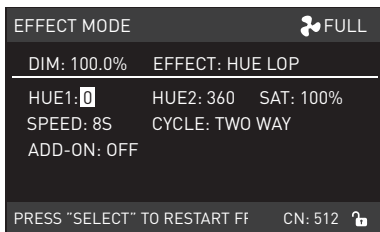

Rotate "middle knob" to set the parameters of the corresponding options.



· HUE LOOP EFFECT has three cycle modes: ONE WAY, TWO WAY and REVERSE. Rotate “middle knob” to select CYCLE mode.

EFFECT MODE		FULL	
DIM: 100.0%	EFFECT: HUE LOP		
HUE1: 1	HUE2: 360 SAT: 100%		
SPEED: 8S	CYCLE: TWO WAY		
ADD-ON: OFF			
PRESS "SELECT" TO RESTART FF		CN: 512	

EFFECT MODE		FULL	
DIM: 100.0%	EFFECT: HUE LOP		
HUE1: 1	HUE2: 360 SAT: 100%		
SPEED: 8S	CYCLE: ONE WAY		
ADD-ON: OFF			
PRESS "SELECT" TO RESTART FF		CN: 512	

Rotate “middle knob” to select CYCLE mode.

Note: (1) When the CYCLE mode is ONE WAY or TWO WAY, press "SELECT knob" to restart from HUE1.

(2) When the CYCLE mode is REVERSE, press "SELECT knob" to restart from HUE2.

· HUE LOOP has four ADD-ON: OFF, FLASH, RANDOM FLASH, PULSE. Rotate “middle knob” to select ADD-ON.

EFFECT MODE		FULL	
DIM: 100.0%	EFFECT: HUE LOP		
HUE1: 1	HUE2: 360 SAT: 100%		
SPEED: 8S	CYCLE: TWO WAY		
ADD-ON: OFF			
PRESS "SELECT" TO RESTART FF		CN: 512	

EFFECT MODE		FULL	
DIM: 100.0%	EFFECT: HUE LOP		
HUE1: 1	HUE2: 360 SAT: 100%		
SPEED: 8S	CYCLE: TWO WAY		
ADD-ON: FLASH	INTERVALS: 1.0S	FLASH RATIO: 50%	
PRESS "SELECT" TO RESTART FF		CN: 512	

Rotate “middle knob” to select CYCLE mode.

Note:

(1) When the ADD- ON is OFF, it means it only has HUE LOOP effect without any ADD-ON effect.

(2) When the ADD-ON is FLASH, it means HUE LOOP effect superimposes FLASH effect. Adjusting the value of INTERVALS and FLASH RATIO to set up FLASH effect. The INTERVALS range is from 0.1S to 10S while the FLASH RATIO range is from 0%--100%.

(3) When the ADD-ON is RANDOM FLASH, it means HUE LOOP effect superimposes FLASH effect. The FLASH effect is RANDOM FLASH and speed adjustable. The SPEED range is from 1-100.

(4) When the ADD-ON is PULSE, it means HUE LOOP effect superimposes PULSE effect. Adjusting the PULSE/MINS to set up PULSE effect. The PULSE/MIN range is from 1-240.

② CCT LOOP

CCT LOOP setting: Rotate "SELECT knob" to select CCT1 (Range: 2700K-7500K), CCT2 (Range: 2700K-7500K), G/M, SPEED (Range: 2S-30S), CYCLE, ADD-ON, then rotate "middle knob" to set the parameters of the corresponding options.

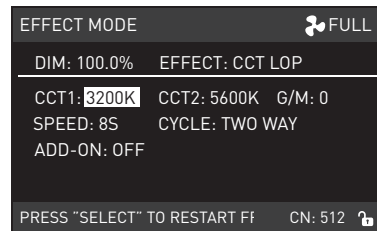
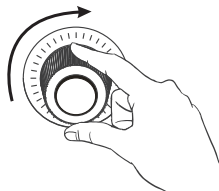
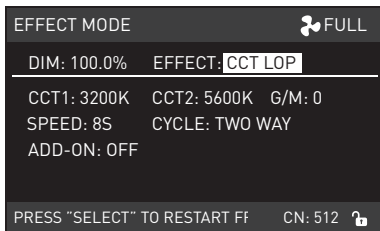

Rotate "SELECT" knob to select CCT1, CCT2, G/M, SPEED, CYCLE, ADD-ON.

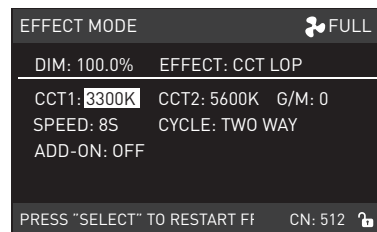
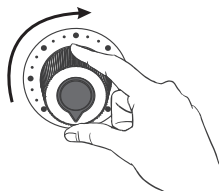
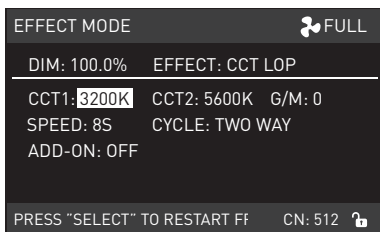

Rotate "middle knob" to set the parameters of the corresponding options.

Notes: (1) In CCT LOOP effect, the type, setting and range of CYCLE and ADD-ON are the same as in HUE LOOP effect.

(2) When the CYCLE mode is ONE WAY or TWO WAY, press "SELECT" knob to restart from CCT1.

(3) When the CYCLE mode is REVERSE, press "SELECT" knob to restart from CCT2.

(4) When setting CCT1, CCT2, press "middle knob" to quickly adjust the color temperature in sequence: 2700K, 3200K, 4300K, 5600K, 6500K, 7500K.

③ INT LOOP

INT LOOP setting: Rotate "SELECT knob" to select color. COLOR: CCT and HSI.

- When the COLOR is CCT, rotate "SELECT knob" to select CCT, G/M, SPEED (Range: 2S-30S), CYCLE, DIMMING RANGE, ADD-ON, then rotate "middle knob" to set the parameters of the corresponding options.

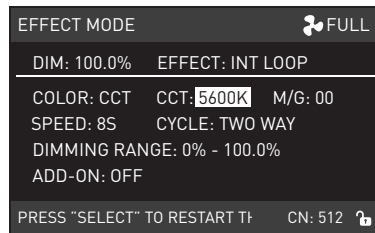
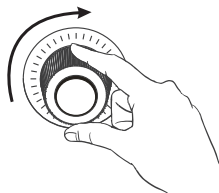
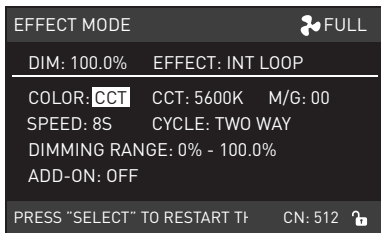

Rotate "SELECT knob" to select CCT, G/M, SPEED, CYCLE, DIMMING RANGE, ADD-ON.

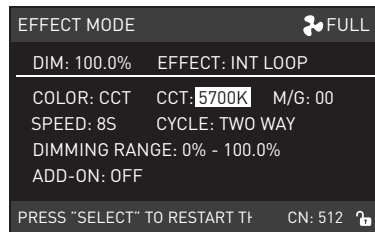
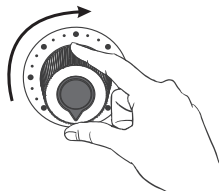
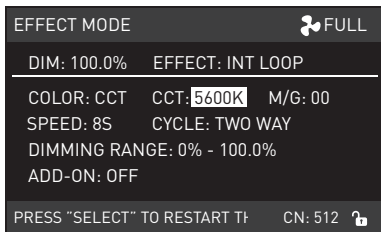

Rotate "middle knob" to set the parameters of the corresponding options.

- When COLOR is HSI, rotate "SELECT knob" to select HSI, SAT, SPEED (Range: 2S-30S), CYCLE, DIMMING RANGE, ADD-ON, then rotate "middle knob" to set the parameters of the corresponding options. (Same operation as CCT)
- INT LOOP has three CYCLE modes: ONE WAY, TWO WAY and REVERSE; and has four ADD-ON: OFF, FLASH, RANDOM FLASH, PULSE.

Note: (1) The operation of CYCLE mode and ADD-ON are same as the operation of HUE LOOP effect.

(2) In INT LOOP, press "SELECT knob" to restart loop.

④ FLASH

FLASH setting: Rotate "SELECT knob" to select COLOR. COLOR: CCT and HSI.

- When COLOR is CCT, rotate "SELECT knob" to select CCT, G/M, INTERVALS (Range: 0.1S-10S), FLASH RATIO (Range: 0%-100%), PAUSE, then rotate "middle knob" to set the parameters of the corresponding options.

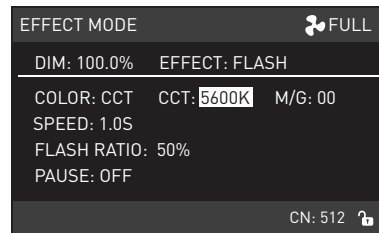
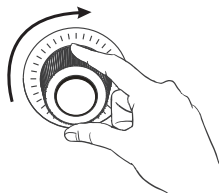
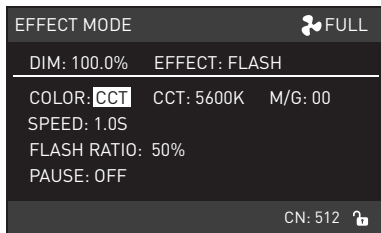

Rotate "SELECT knob" to select CCT, G/M, INTERVALS, FLASH RATIO, PAUSE.

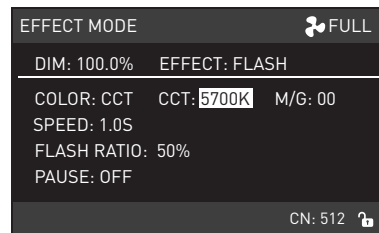
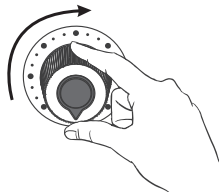
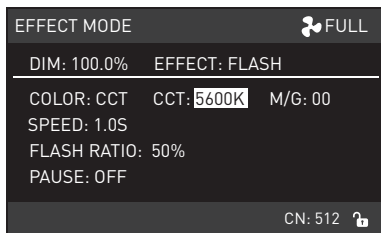

Rotate "middle knob" to set the parameters of the corresponding options.

- When COLOR is HSI, rotate "SELECT knob" to select HUE, SAT, INTERVALS, FLASH RATIO, PAUSE, then rotate "middle knob" to set the parameters of the corresponding options. (Same as CCT)

Note: PAUSE has two options: ON and OFF. When PAUSE is ON, the FLASH paused.

⑤ PULSE

PULSE setting: Rotate "SELECT knob" to select COLOR. COLOR: CCT and HSI.

- When COLOR is CCT, rotate "SELECT knob" to select CCT, G/M, PULSES/MIN (Range:1-240), then rotate "middle knob" to set the parameters of the corresponding options.

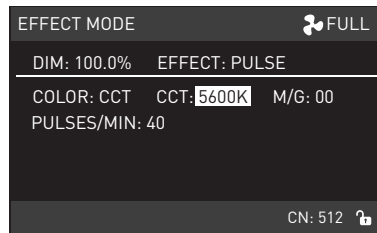
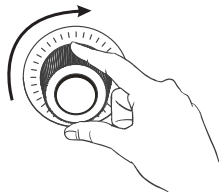
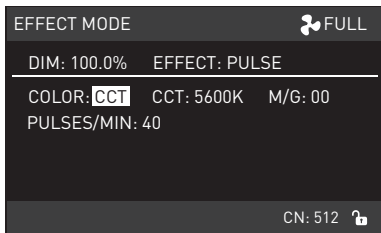

Rotate "SELECT knob" to select CCT, G/M, PULSES/MIN.

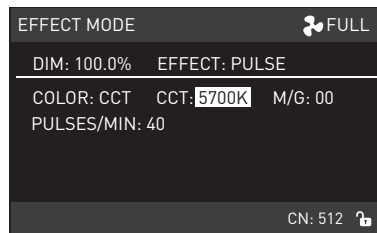
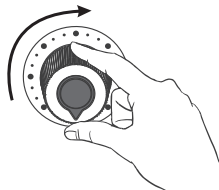
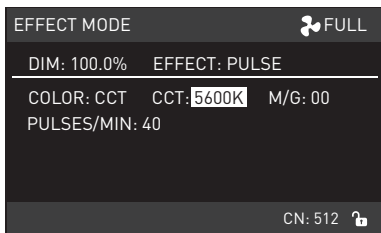

Rotate "middle knob" to set the parameters of the corresponding options.

- When the COLOR is HSI, rotate "SELECT knob" to select HUE, SAT, PULSES/MIN (Range: 1-240), then rotate "middle knob" to set the parameters of the corresponding options. (Same operation as CCT)

⑥ STORM

STORM setting: Rotate "SELECT" knob to select trigger. TRIGGER: AUTO and MANUAL.

- When TRIGGER is AUTO, rotate "SELECT knob" to select CCT, FLASH TIMES (Range: 1-10), INTERVAL RANGE (Range: 1S-60S), PAUSE, then rotate "middle knob" to set the parameters of the corresponding options. Note: PAUSE: ON and OFF. When PAUSE is ON, the fixture is always on.

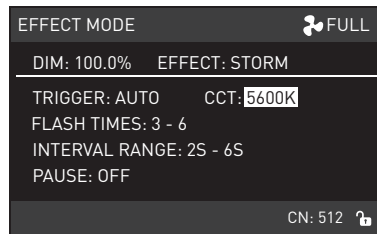
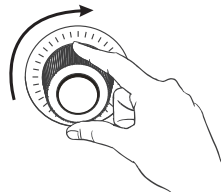
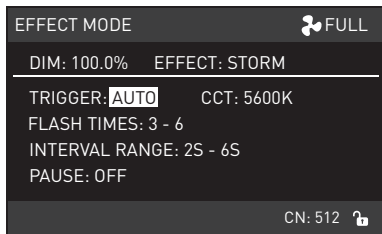

Rotate "SELECT knob" to select CCT, FLASH TIMES, INTERVALS RANGE, PAUSE.

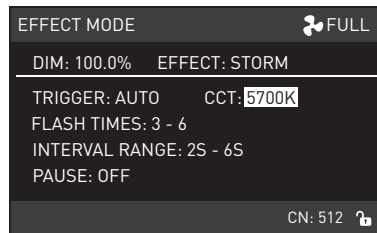
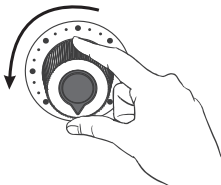
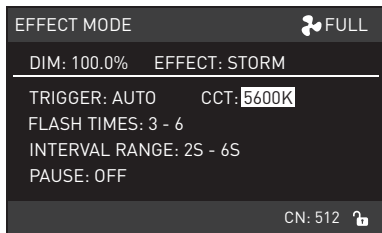

Rotate "middle knob" to set the parameters of the corresponding options.

- When TRIGGER is MANUAL, Rotate "SELECT knob" to select CCT, FLASH TIMES, then rotate "middle knob" to set the parameters of the corresponding options. Press "SELECT knob" to trigger STORM effect.

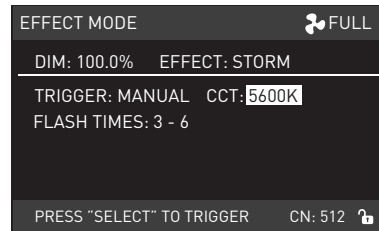
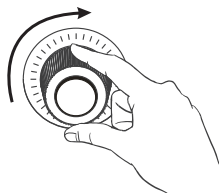
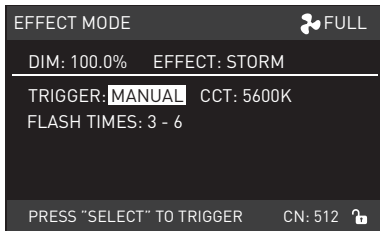

Rotate "SELECT knob" to select CCT, FLASH TIMES.

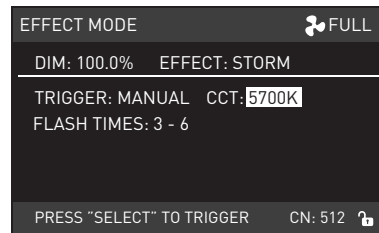
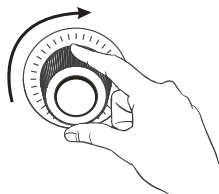
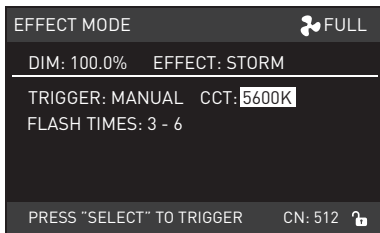

Rotate "middle knob" to set the parameters of the corresponding options.

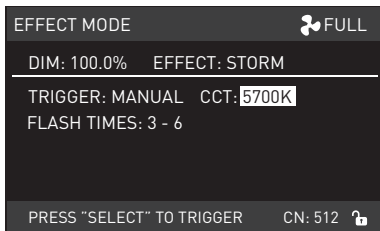

Press "SELECT knob" to trigger STORM effect.

⑦ POLICE CAR

POLICE CAR setting, Rotate "SELECT knob" to select COLOR, MODE, SPEED (Range: 1-100). COLOR: BLUE, RED&BLUE, BLUE&WHITE, RED&BLUE&WHITE, MODE: SINGLE, DOUBLE, TRIPLE, QUAD.

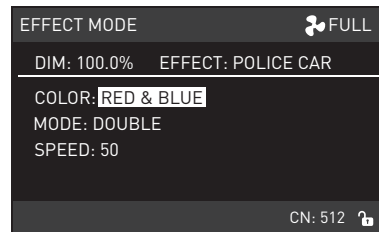
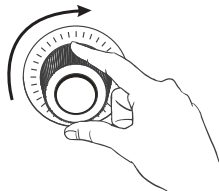
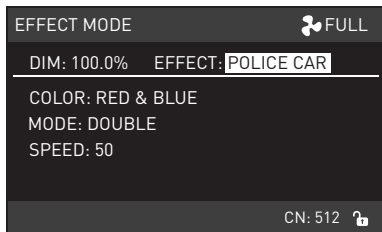

Rotate "SELECT knob" to select COLOR, MODE, SPEED.

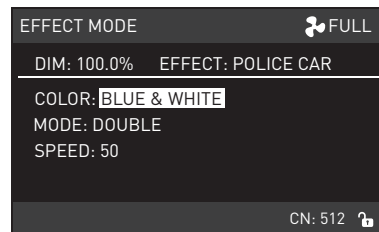
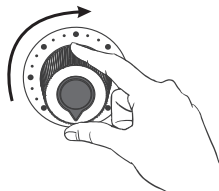
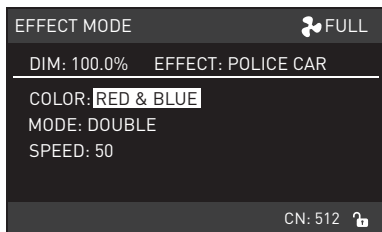

Rotate "middle knob" to set the parameters of the corresponding options.



⑧ TV

TV setting, Rotate "SELECT knob" to select COLOR. COLOR: CCT and HSI.

- When COLOR is CCT, rotate "SELECT knob" to select CCT, G/M, CCT SHIFT (Range:0K-3000K), SPEED (Range: 1-100), DIMMING RANGE, then rotate "middle knob" to set the parameters of the corresponding options.

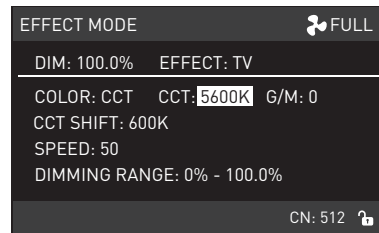
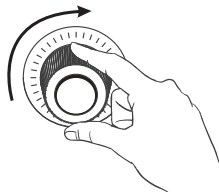
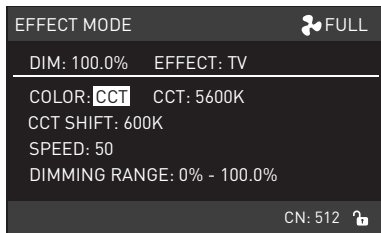

Rotate "SELECT knob" to select CCT, G/M, CCT SHIFT, SPEED, DIMMING RANGE.

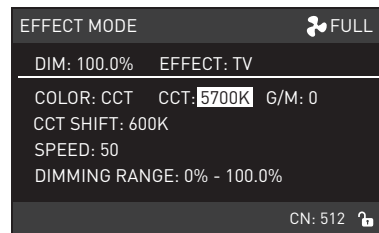
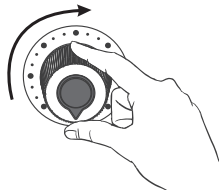
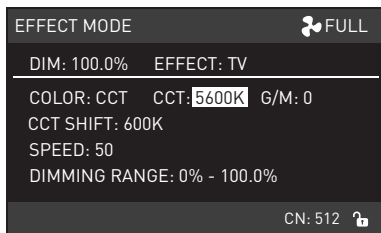

Rotate "middle knob" to set the parameters of the corresponding options.

- When the COLOR is HSI, rotate "SELECT knob" to select HUE, SAT, HUE SHIFT (Range:0-180), SPEED (Range: 1-100), DIMMING RANGE, then rotate "middle knob" to set the parameters of the corresponding options. (Same operation as CCT)

⑨ PAPAARAZZI

PAPAARAZZI setting, Rotate "SELECT knob" to select CCT, G/M, SPEED (Range: 1-100), then rotate "middle knob" to set the parameters of the corresponding options.

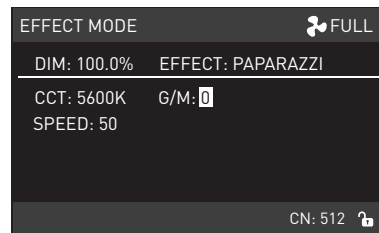
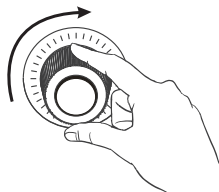
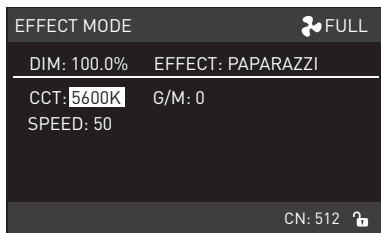

Rotate "SELECT knob" to select CCT, G/M, SPEED.

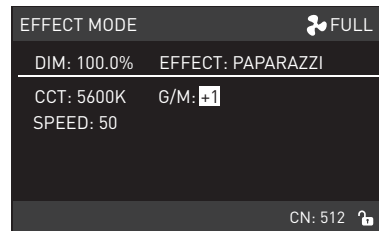
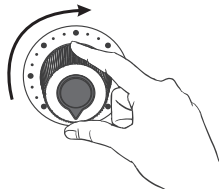
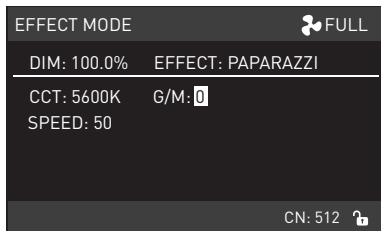

Rotate "middle knob" to set the parameters of the corresponding options.

⑩ CANDLE/FIRE

CANDLE/FIRE setting, Rotate "SELECT knob" to select COLOR. COLOR: CCT and HSI.

- When COLOR is CCT, rotate "SELECT knob" to select CCT (Range:1800K-7500K), G/M, SPEED (Range: 1-100), CCT SHIFT (Range: 0K-3000K), DIMMING RANGE, FLASH, then rotate "middle knob" to set the parameters of the corresponding options.

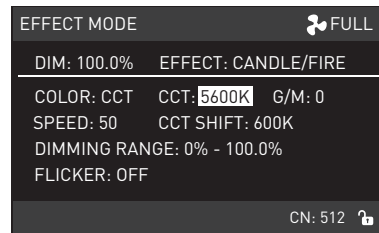
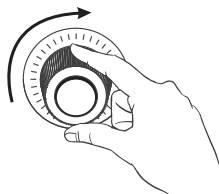
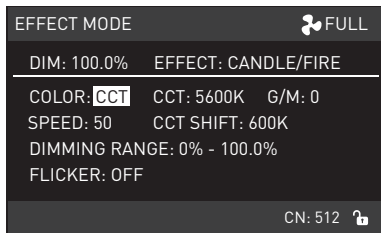

Rotate "SELECT knob" to select CCT, G/M, SPEED, CCT SHIFT, DIMMING RANGE, FLASH.

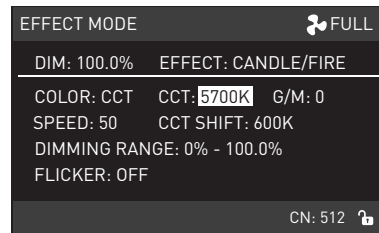
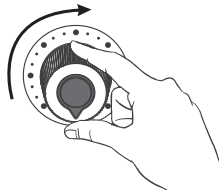
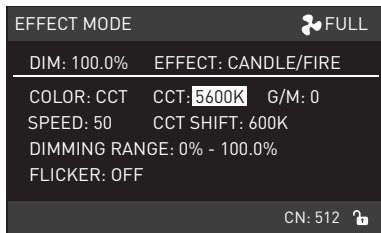

Rotate "middle knob" to set the parameters of the corresponding options.

- When the COLOR is HSI, Rotate "SELECT knob" to select HUE, SAT, SPEED (Range: 1-100), HUE SHIFT (Range: 0-180), DIMMING RANGE, FLASH, then rotate "middle knob" to set the parameters of the corresponding options. (Same operation as CCT)

Note: FLASH: ON and OFF, circularly adjustable. When FLASH is ON, CANDLE/FIRE effect shows FLASH.

⑩ DISCO

DISCO setting, Rotate "SELECT knob" to select COLOR. COLOR: DEFAULT and MANUAL.

- When the COLOR is DEFAULT, rotate "SELECT knob" to select AMOUNT (Range: 3, 6, 9, 12, 15, 18, 21, 24), SPEED (Range: 1-100), SAT, then rotate "middle knob" to set the parameters of the corresponding options.

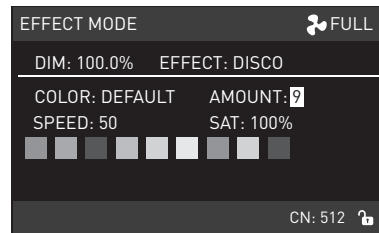
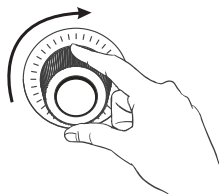
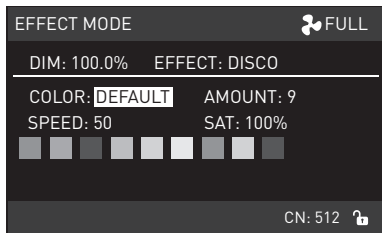

Rotate "SELECT knob" to select AMOUNT, SPEED, SAT.

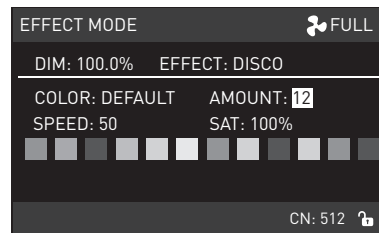
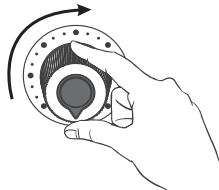
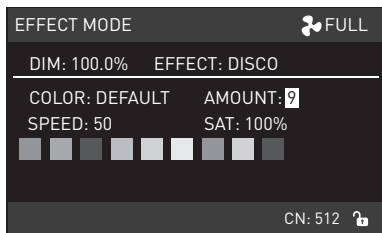

Rotate "middle knob" to set the parameters of the corresponding options.

- When the COLOR is MANUAL, rotate "SELECT knob" to select AMOUNT (Range: 1-6), SPEED (Range: 1-100), SAT. Different AMOUNT displays different HUE. For example, AMOUNT is 1, C1 is displayed at the bottom of the screen; AMOUNT is 2, C1, C2 are displayed at the bottom of the screen, and so on. The range of C1-C6 is 0-360, then rotate "middle knob" to set the parameters of the corresponding options.

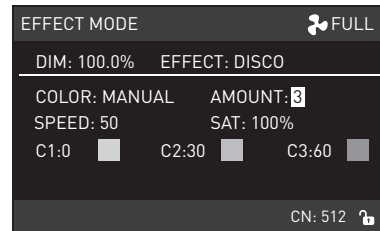
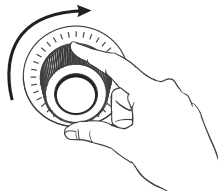
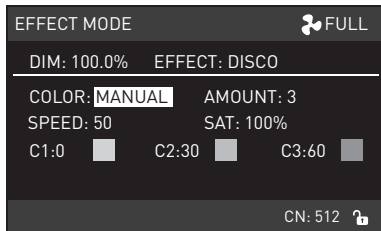

Rotate "SELECT knob" to select AMOUNT, SPEED, SAT.

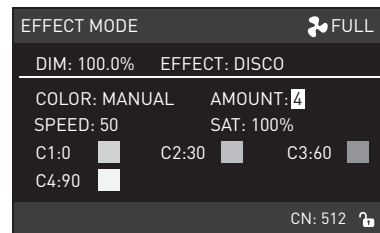
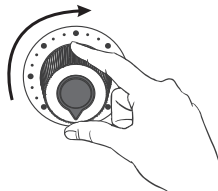
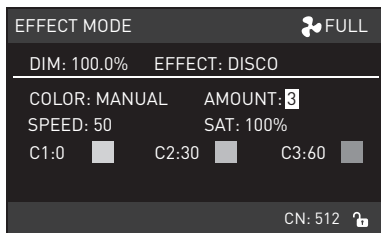

Rotate "middle knob" to set the parameters of the corresponding options.

⑫ BAD BULB

BAD BULB setting: Rotate "SELECT knob" to select COLOR. COLOR: CCT and HSI.

- When the COLOR is CCT, rotate "SELECT knob" to select CCT, G/M, INTENSITY (Range:1-100), SPEED (Range:1-100), then rotate "middle knob" to set the parameters of the corresponding options.

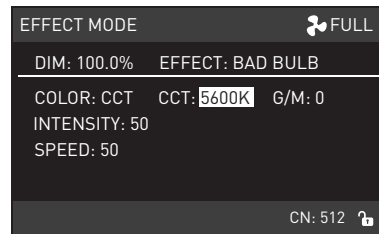
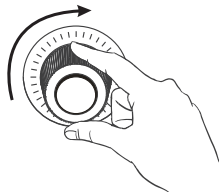
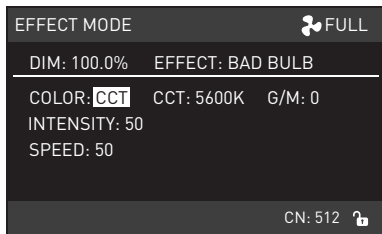

Rotate "SELECT knob" to select CCT, G/M, INTENSITY, SPEED.

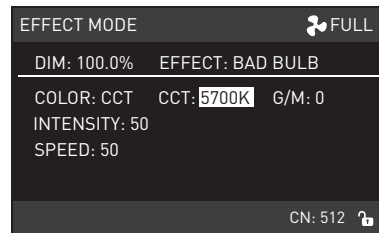
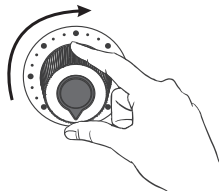
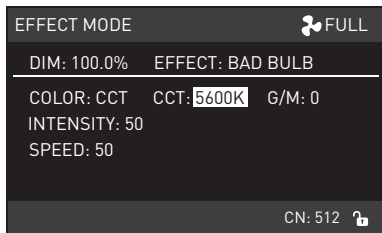

Rotate "middle knob" to set the parameters of the corresponding options.

- When the COLOR is HSI, rotate "SELECT knob" to select HUE, SAT, INTENSITY (Range:1-100), SPEED (Range: 1-100), then rotate "middle knob" to set the parameters of the corresponding options. (Same operation as CCT)

⑬ FIREWORK

FIREWORK setting: Rotate "SELECT knob" to select COLOR, COLOR: DEFAULT, MANUAL and CCT.

- When the COLOR is DEFAULT, rotate "SELECT knob" to select AMOUNT (Range: 3, 6, 9, 12, 15, 18, 21, 24), SPEED (Range: 1-100), DECAY (Range: 1-100), SAT, then rotate "middle knob" to set the parameters of the corresponding options.

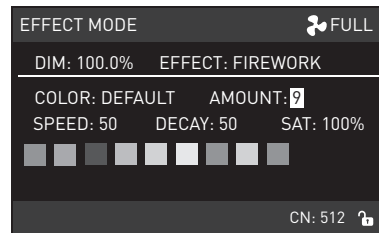
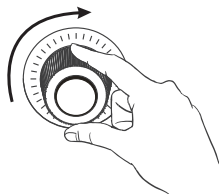
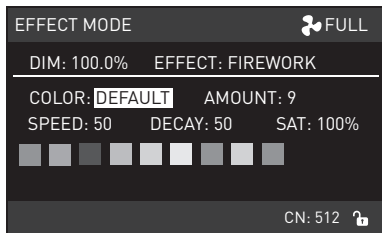

Rotate "SELECT knob" to select AMOUNT, SPEED, DECAY, SAT.

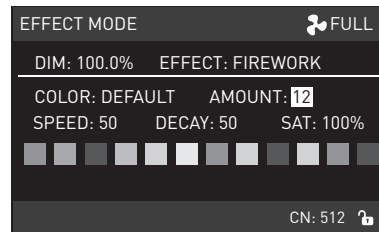
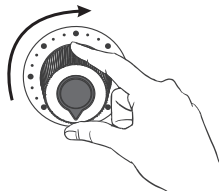
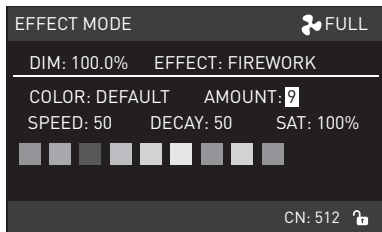

Rotate "middle knob" to set the parameters of the corresponding options.

· When the COLOR is MANUAL, rotate "SELECT knob" to select AMOUNT (Range: 1-6), SPEED (Range: 1-100), SAT. Different AMOUNT displays different HUE. For example, AMOUNT is 1, C1 is displayed at the bottom of the screen; AMOUNT is 2, C1, C2 are displayed at the bottom of the screen, and so on. The range of C1-C6 is 0-360, then rotate "middle knob" to set the parameters of the corresponding options.

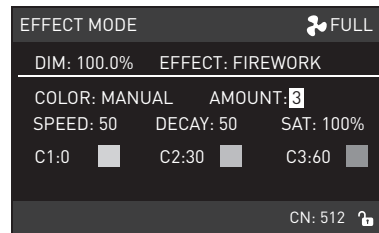
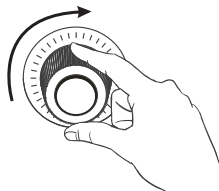
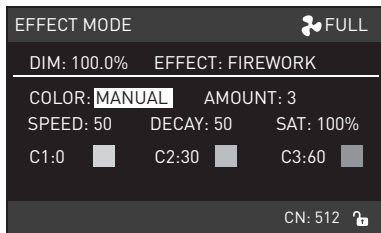

Rotate "SELECT knob" to select AMOUNT, SPEED, SAT.

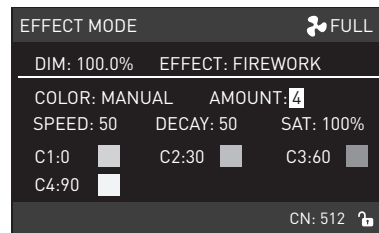
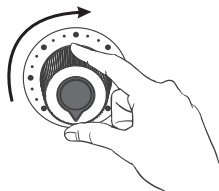
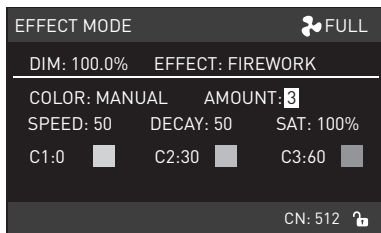

Rotate "middle knob" to set the parameters of the corresponding options.



- When the COLOR is CCT, rotate "SELECT knob" to select CCT, G/M, CCT SHIFT (0-3000K), SPEED (Range: 1-100), DECAY (Range: 1-100), then rotate "middle knob" to set the parameters of the corresponding options.

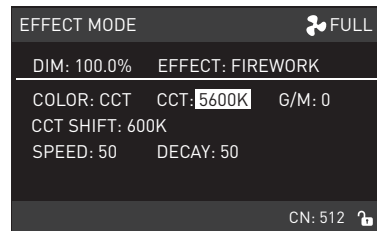
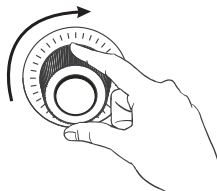
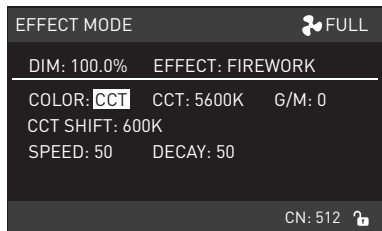

Rotate "SELECT knob" to select CCT, G/M, CCT SHIFT, SPEED, DECAY.

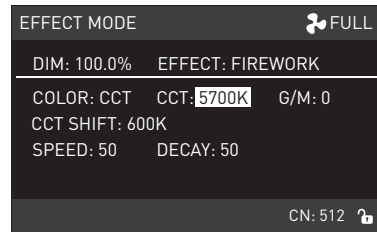
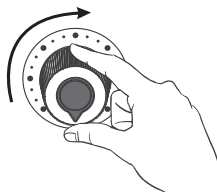
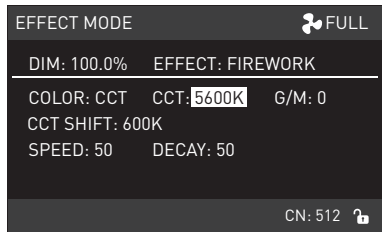

Rotate "middle knob" to set the parameters of the corresponding options.

⑭ EXPLOSION

EXPLOSION setting: Rotate "SELECT knob" to select TRIGGER, COLOR. TRIGGER: AUTO and MANUAL, COLOR: CCT and HSI.

- When the TRIGGER is AUTO and the COLOR is CCT, rotate "SELECT knob" to select CCT, G/M, SPEED (Range: 1-100), DECAY (Range: 1-100), then rotate "middle knob" to set the parameters of the corresponding options.

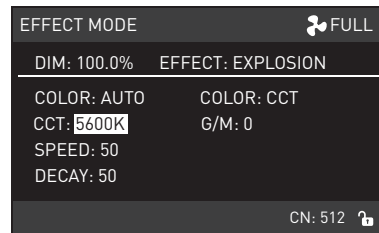
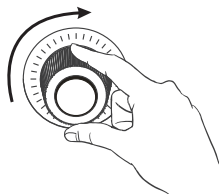
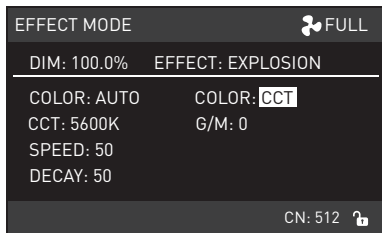

Rotate "SELECT knob" to select CCT, G/M, SPEED, DECAY.

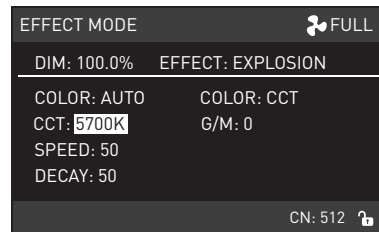
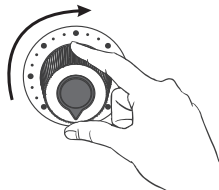
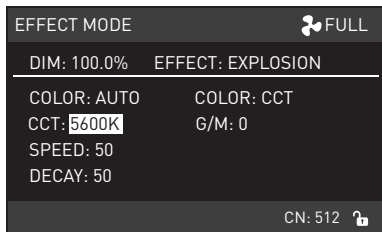

Rotate "middle knob" to set the parameters of the corresponding options.

- When the TRIGGER is AUTO and the COLOR is HSI, rotate "SELECT knob" to select HUE, SAT, SPEED (Range: 1-100), DECAY (Range: 1-100), then rotate "middle knob" to set the parameters of the corresponding options. (Same operation as CCT)

- When the TRIGGER is MANUAL and the COLOR is CCT, rotate "SELECT knob" to select CCT, G/M, DECAY (Range: 1-100), then rotate "middle knob" to set the parameters of the corresponding options. Press "SELECT knob" to trigger EXPLOSION.

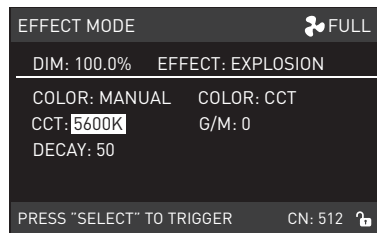
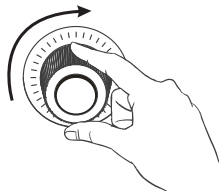
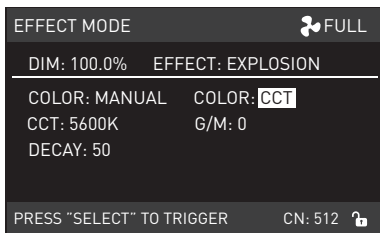

Rotate "SELECT knob" to select CCT, G/M, DECAY.

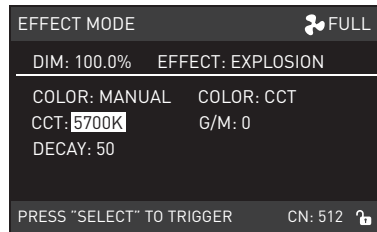
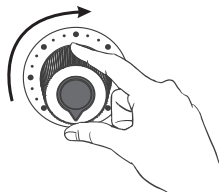
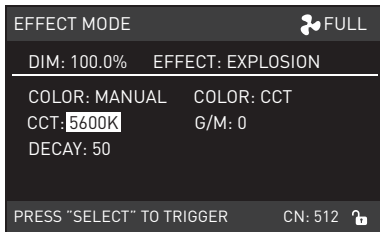

Rotate "middle knob" to set the parameters of the corresponding options.

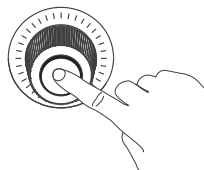
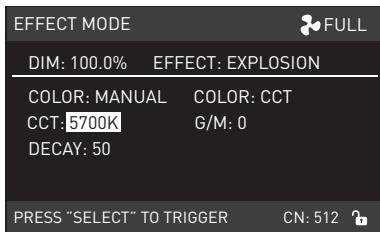

PRESS "SELECT knob" to trigger EXPLOSION.

- When the TRIGGER is MANUAL and the COLOR is HSI, rotate "SELECT knob" to select HUE, SAT, DECAY (Range: 1-100), then rotate "middle knob" to set the parameters of the corresponding options. Press "SELECT knob" to trigger EXPLOSION. (Same operation as CCT)

15 WELDING

WELDING setting, Rotate "SELECT knob" to select COLOR. COLOR: CCT and HSI.

- When the COLOR is CCT, rotate "SELECT knob" to select CCT, G/M, SPEED (Range: 1-100), DIMMING RANGE, PAUSE, then rotate "middle knob" to set the parameters of the corresponding options.

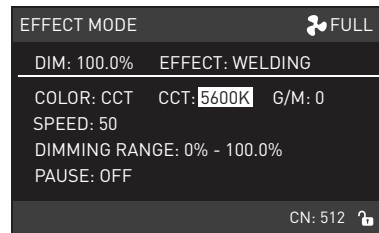
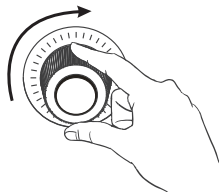
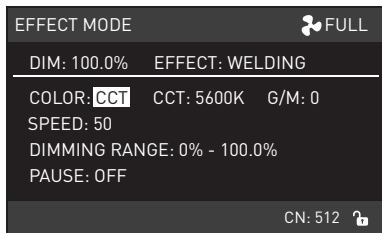

Rotate "SELECT knob" to select CCT, G/M, SPEED, DIMMING, PAUSE.

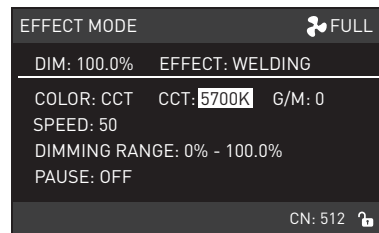
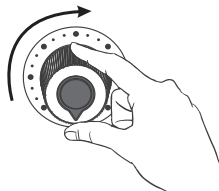
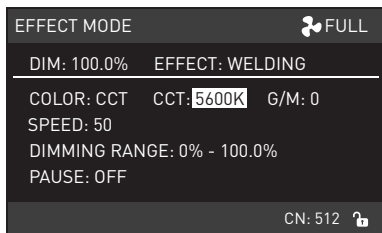

Rotate "middle knob" to set the parameters of the corresponding options.

- When the COLOR is HSI, rotate "SELECT knob" to select HUE, SAT, SPEED (Range: 1-100), DIMMING RANGE, PAUSE, then rotate "middle knob" to set the parameters of the corresponding options. (Same operation as CCT)

Note: PAUSE: ON and OFF. When PAUSE is ON, WELDING effect PAUSE.

- Lighting effects and additional function maybe added with future firmware updates, for details please check from [www.nanlux.com](http://www.nanlux.com).

7. PRESET Key: Press PRESET key to enter the operation interface of PRESET.

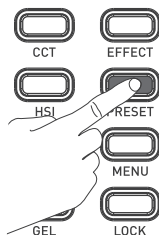
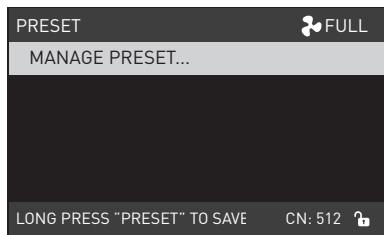

(Left knob)



(Middle knob)

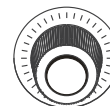

(SELECT knob)

· Switch MANAGE PRESET or EXIT MANAGE.

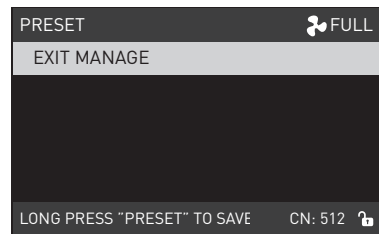
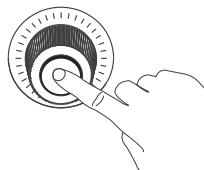

Press "SELECT knob" to Switch MANAGE PRESET or EXIT MANAGE.

① Save current lighting setting: When the lighting is set, long press PRESET key to enter the name interface of MANAGE PRESET, rename and save current lighting setting.

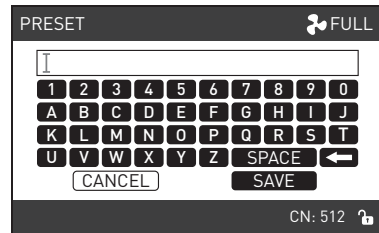
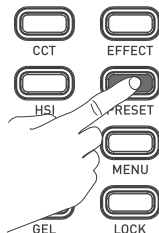
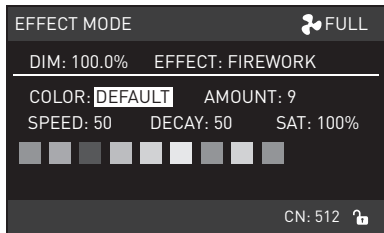

Long press PRESET key to enter the name interface of MANAGE PRESET.

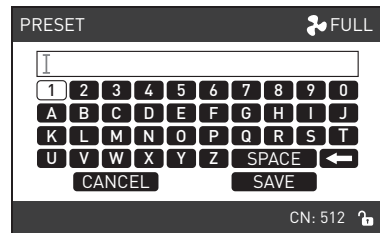
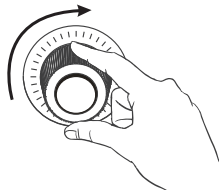
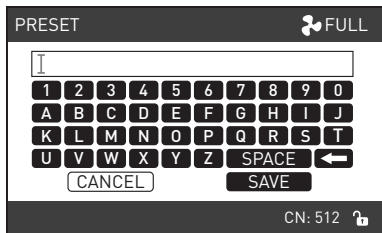

Rotate "SELECT knob" to select the number or letter according to demands.

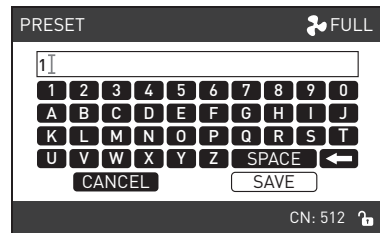
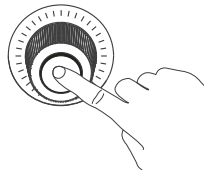
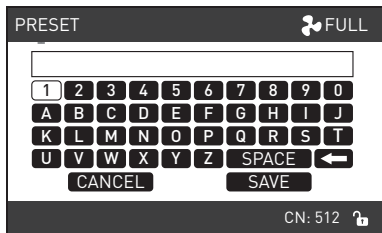

Press "SELECT knob" to confirm.

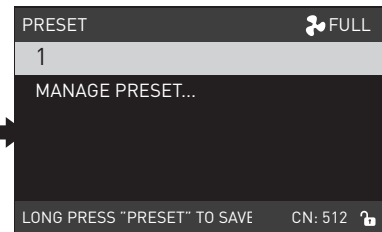
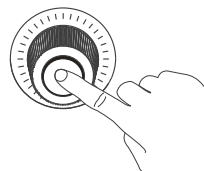
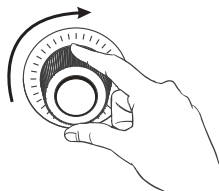
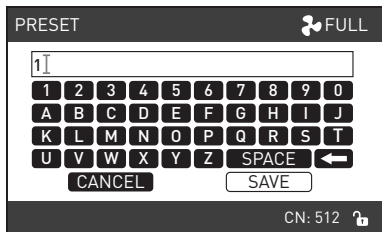

Rotate "SELECT knob" to save, press "SELECT knob" to confirm.

② TRIGGER PRESET LIGHTING: Press PRESET key to enter the interface of PRESET, rotate "SELECT knob" to select preset lighting, press "SELECT knob" to trigger preset lighting, the screen displays the interface of the saved lighting mode.

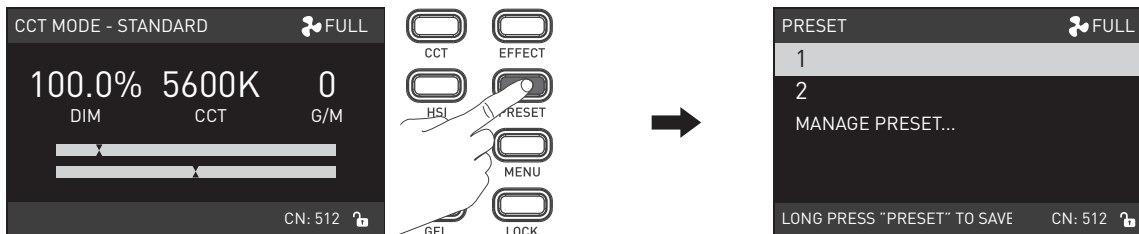

Press PRESET key to enter the interface of PRESET.

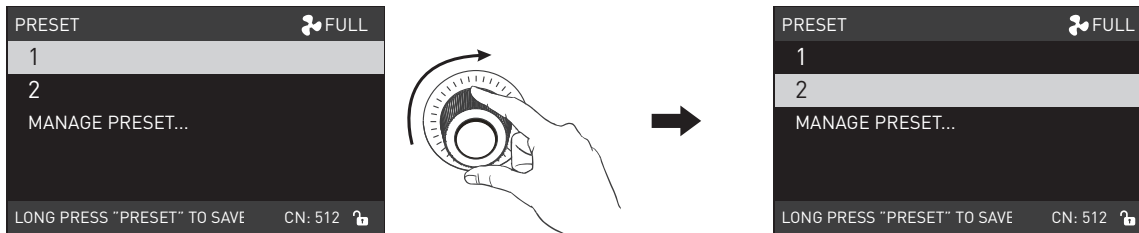

Rotate "SELECT knob" to select lighting PRESET.

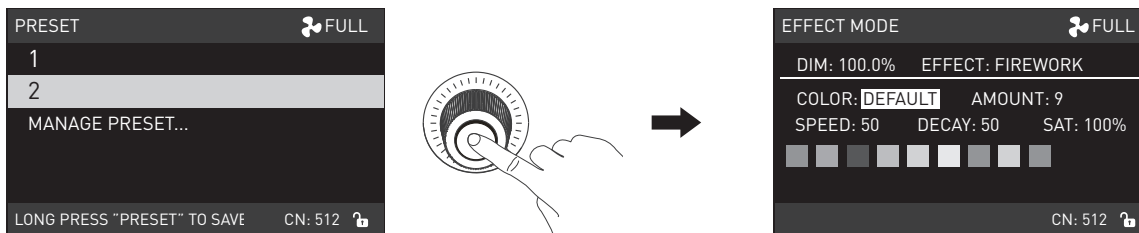

Press "SELECT knob" to trigger lighting PRESET, the screen displays the interface of the saved lighting mode.

③ Rename or delete saved preset lighting: Press PRESET key to enter the interface of PRESET, rotate "SELECT knob" to select MANAGE PRESET, press "SELECT knob" to switch to EXIT MANAGE, then rotate "SELECT knob" to select rename or delete saved preset lighting.

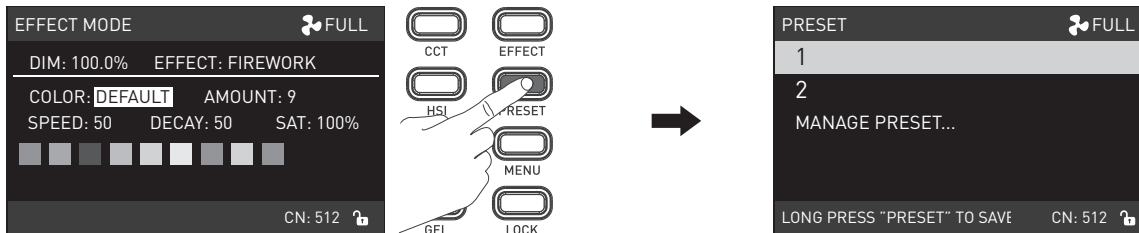

Press PRESET key to enter the interface of PRESET.

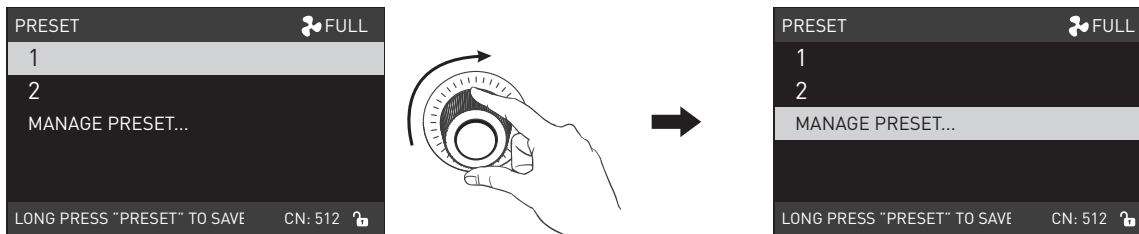

Rotate "SELECT knob" to select MANAGE PRESET.

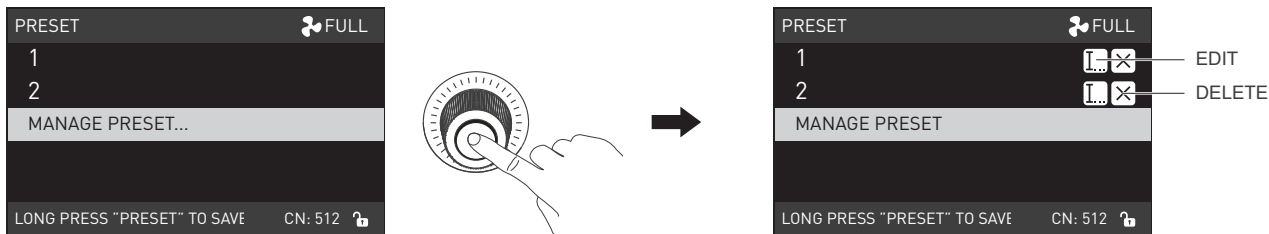

Press "SELECT knob" to switch to EXIT MANAGE.



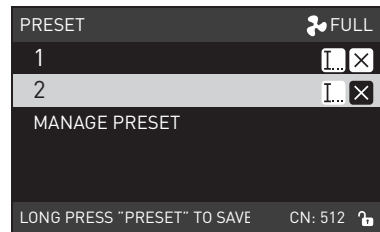
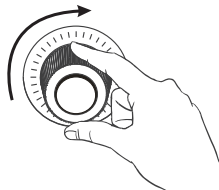

Rotate "SELECT knob" to select rename or delete lighting PRESET.

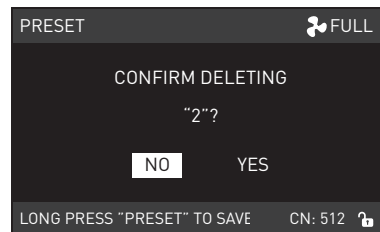
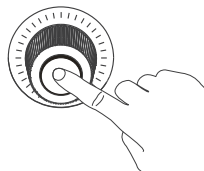
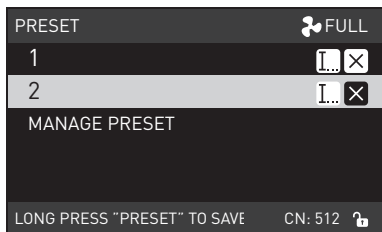

Press "SELECT knob" to delete the lighting preset.

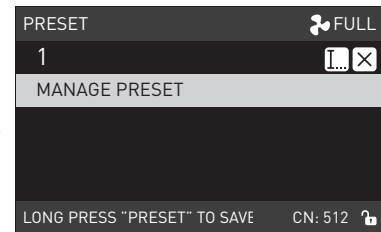
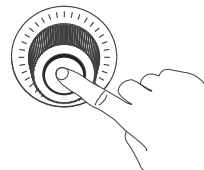
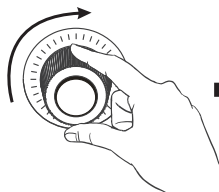

Rotate "SELECT knob" to select YES, press "SELECT knob" to confirm deleting lighting preset.

8. MENU Key: Press MENU key to access options.

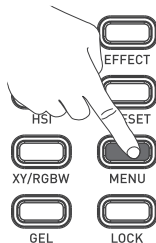
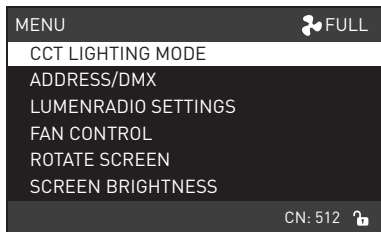

(Left knob)



(Middle knob)

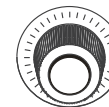

(SELECT knob)

- Rotate "SELECT knob" to select setting item, press "SELECT knob" to enter corresponding secondary menu, rotate "SELECT knob" again to select corresponding option, press "SELECT knob" to set or press MENU key to return to the previous menu.

① CCT MODE

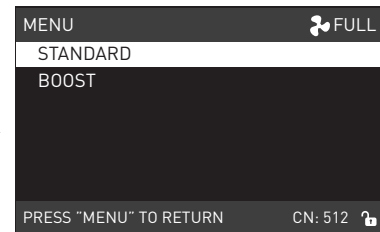
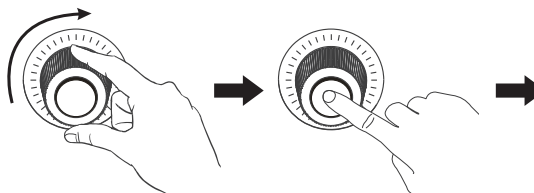
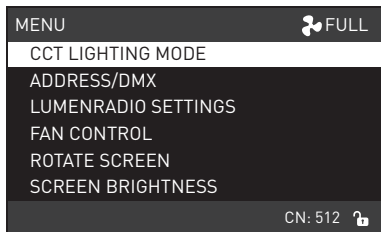

Rotate "SELECT knob" to CCT MODE, press "SELECT knob" to enter corresponding secondary menu.

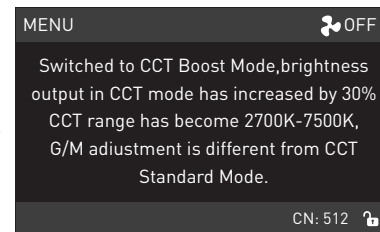
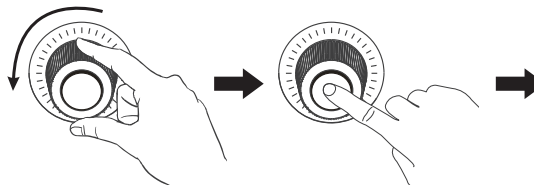
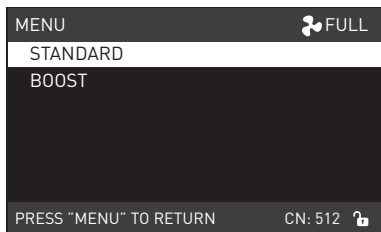

Rotate "SELECT knob" to switch CCT MODE: STANDARD MODE or BOOST MDOE, press "SELECT knob" to set.

Notes: (1) Switched to CCT Standard Mode, brightness output in CCT mode has become standard, CCT range has become 2700K-20000K, G/M adjustment is different from CCT Boost Mode.

(2) Switched to CCT Boost Mode, brightness output in CCT mode has increased by 30%, CCT range has become 2700K-7500K, G/M adjustment is different from CCT Standard Mode.

② ADDRESS/DMX

For more operation details please refer to P12.

③ LUMENRADIO SETTINGS

For more operation details please refer to P17.

④ FAN CONTROL

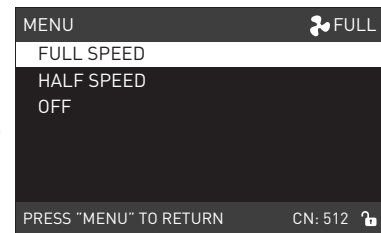
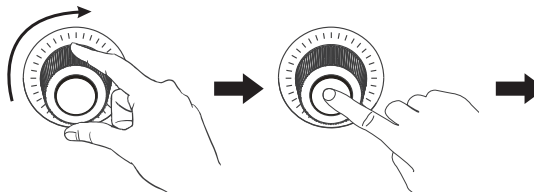
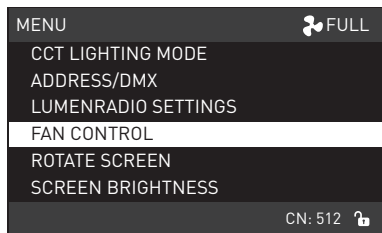

Rotate "SELECT knob" to FAN CONTROL, press "SELECT knob" to enter corresponding secondary menu.

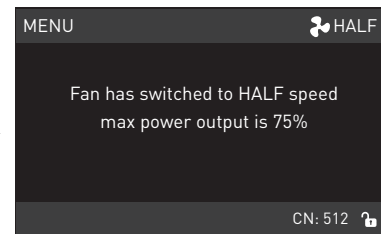
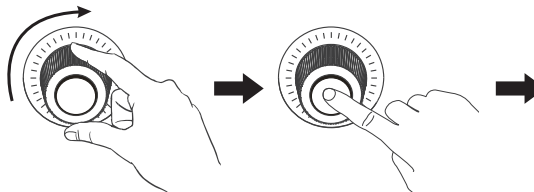
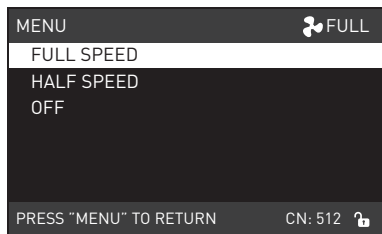

Rotate "SELECT knob" to switch FAN SPEED: FULL SPEED, HALF SPEED, OFF. Press "SELECT knob" to set.

Note: (1) Fan has switched to FULL SPEED, Max power output is 100%.

(2) Fan has switched to HALF SPEED, Max power output is 75%.

(3) Fan has switched OFF, Max power output is 45%.

⑤ ROTATE SCREEN

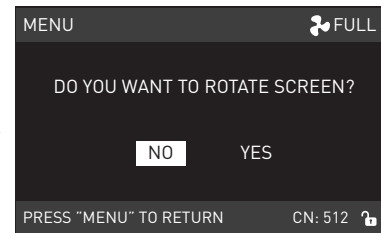
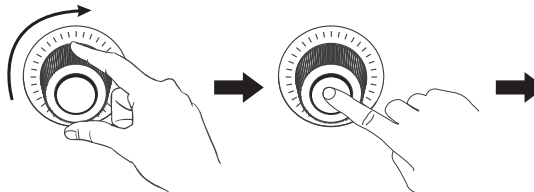
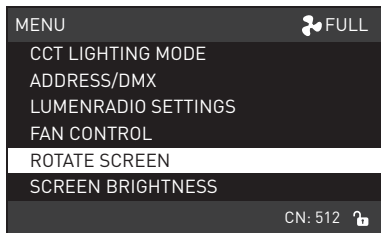

Rotate "SELECT knob" to ROTATE SCREEN, press "SELECT knob" to enter corresponding secondary menu.

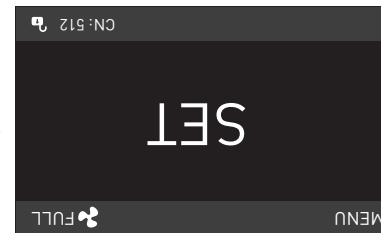
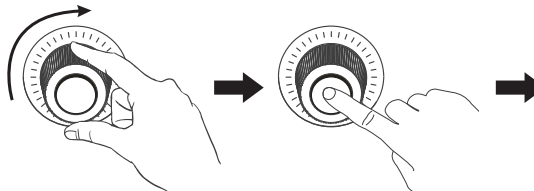
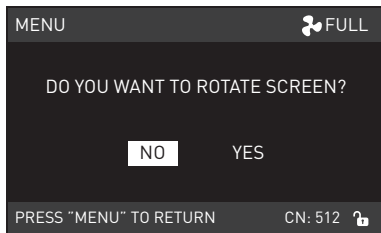

Rotate "SELECT knob" to select YES or NO, press "SELECT knob" to set.

⑥ SCREEN BRIGHTNESS

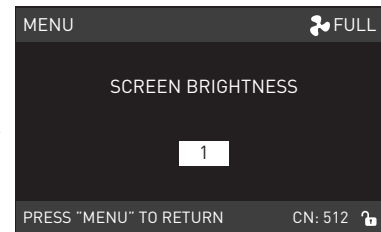
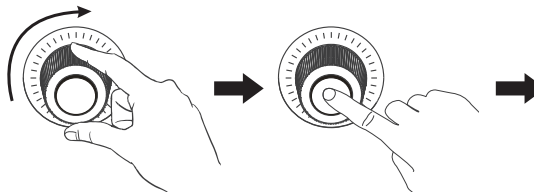
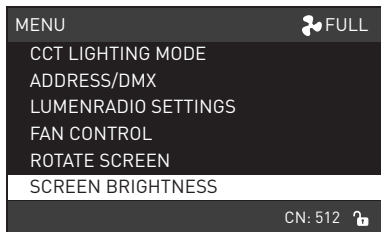

Rotate "SELECT knob" to SCREEN BRIGHTNESS , press "SELECT knob" to enter corresponding secondary menu.

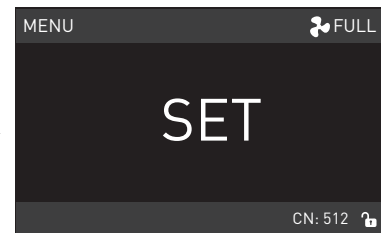
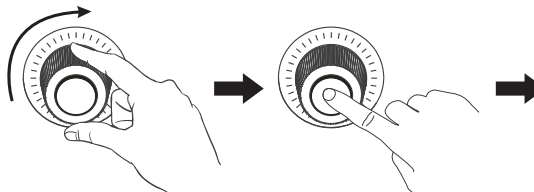
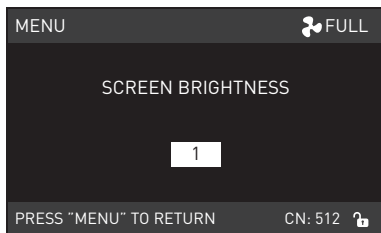

Rotate "SELECT knob" to select SCREEN BRIGHTNESS, press "SELECT knob" to set.

⑦ BUTTON BACKLIGHT

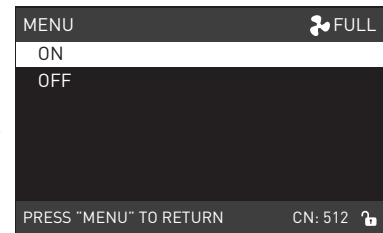
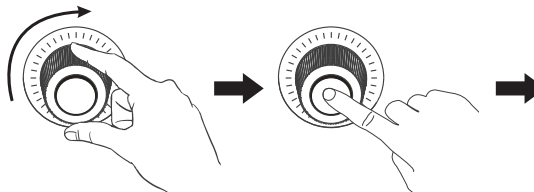
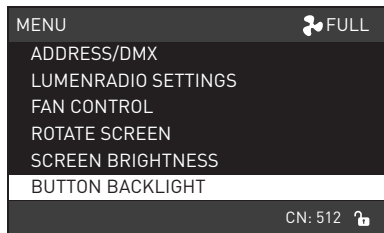

Rotate "SELECT knob" to BUTTON BACKLIGHT, press "SELECT knob" to enter the corresponding secondary menu.

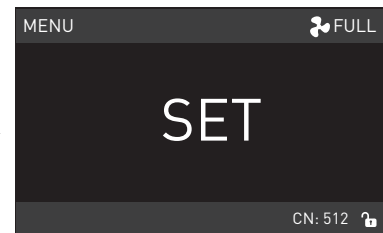
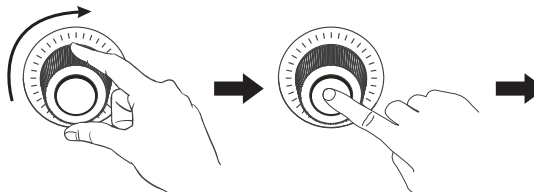
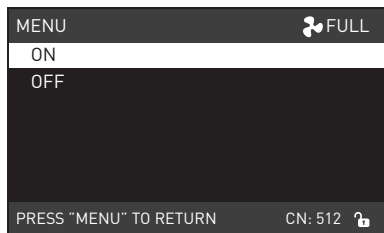

Rotate "SELECT knob" to select ON or OFF, press "SELECT knob" to set.

⑧ LANGUAGE

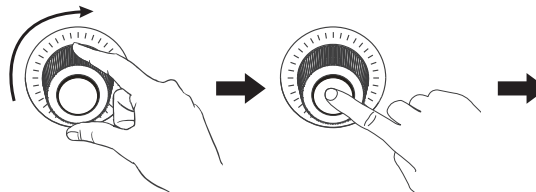
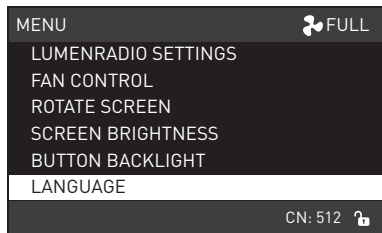

Rotate "SELECT knob" to LANGUAGE, press "SELECT knob" to enter corresponding secondary menu.

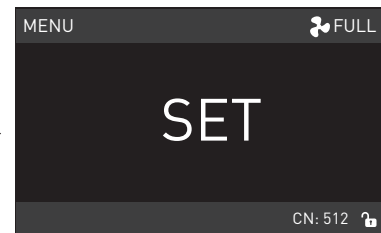
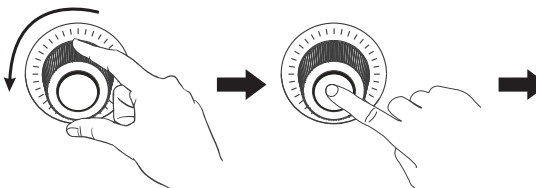

Rotate "SELECT knob" to select ENGLISH or 简体中文, press "SELECT knob" to set.

⑨ RESET ALL SETTINGS

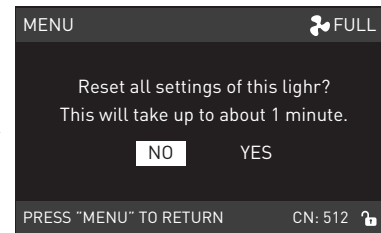
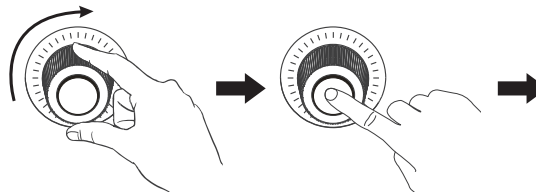
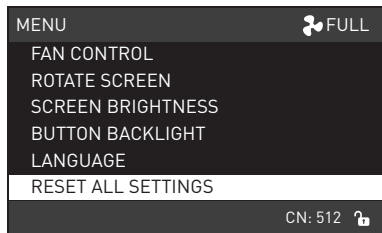

Rotate "SELECT knob" to RESET ALL SETTINGS, press "SELECT knob" to enter corresponding secondary menu.

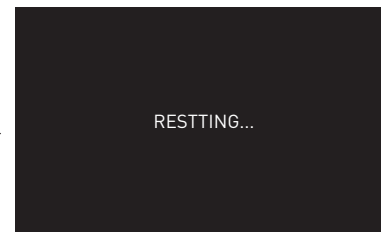
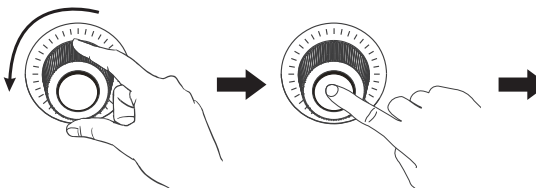
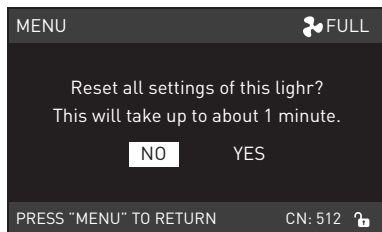

Rotate "SELECT knob" to select YES or NO, press "SELECT knob" to set.

⑩ VERSION

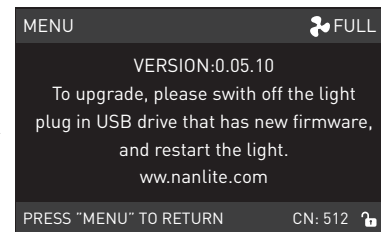
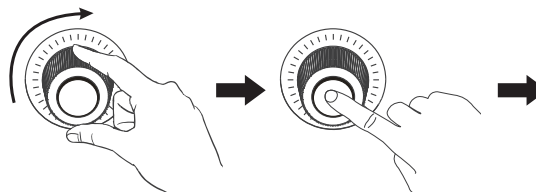
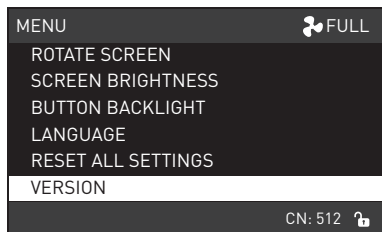

Rotate "SELECT knob" to VERSION, press "SELECT knob" to check the current VERSION.



9. LOCK Key: Long press LOCK key for 2s to lock function, now operation keys or adjustment knobs can not change the current function, long press LOCK key for 2s again to release lock status.

10. When the FAN works abnormally, the screen displays as below image, this time the light has switched to OFF, press any key or knob to return.

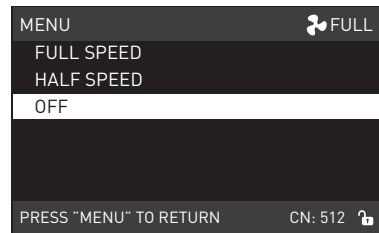
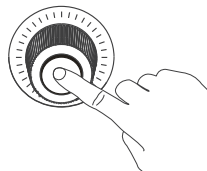
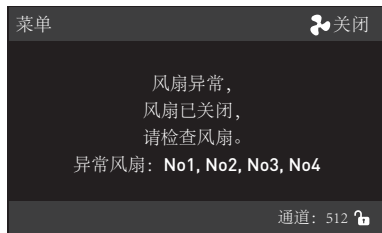

11. Turn off the power when stop using.

## Safety Precautions

1. Please open the package to check for damage caused in transit, if damaged please do not use and contact place of purchase or manufacturer as soon as possible.
2. Do not use a power cable with damaged insulation. Do not unplug hard or drag the power cable directly.
3. Ensure the power supply's voltage matches the voltage specified by the fixture before installation.
4. When cleaning or not using the light, please turn it off.
5. Store the light safely and away from children.









## Notice

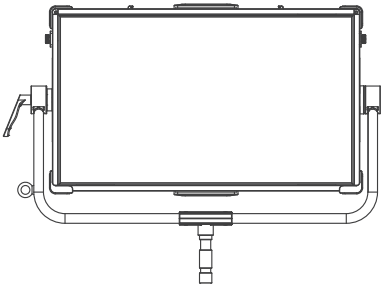



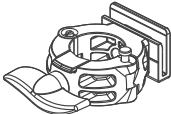

1. Do not place any object on the light emitter.
2. Don't place objects on the light or allow liquid to follow inside the fixture or the emitter.
3. Don't place the light near flammable substances like alcohol or gasoline.
4. When cleaning the light, please wipe off debris or dirt by using a dry cloth with clean water or neutral cleanser.
5. The light should be operated safely where it won't be at risk of getting wet, dusty or under extreme temperature. Meanwhile please check the fan and the vent.
6. Don't repair the light by yourself. Attempts to self repair will void warranty, for repairs please turn to place of purchase.
7. Do not cover the vent while using, avoiding affecting heat dissipation and destructing the light. When using the fixture for a long time, the temperature of the fixture is high, please pay attention to anti-scalding.
8. The light case of Dyno 1200C has the lock function on the universal wheel. Please lock the universal wheel to keep the light case off moving.

## General Fault Detection and Diagnosis

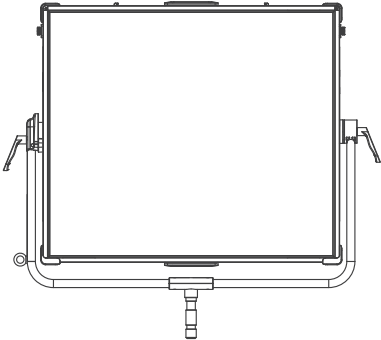
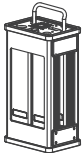
Fault Detection	Diagnosis
The light won't boot up properly	<ol style="list-style-type: none"> <li>1. Please check whether the connection between power adapter, power cable and outlet connection is properly connected or loose.</li> <li>2. Please check whether the voltage value is within the specified parameters.</li> </ol>
The fixture can operate by manual, but DMX control is not working.	<ol style="list-style-type: none"> <li>1. Please check whether the DMX original address setting of the fixture is correct or not.</li> <li>2. Please check that the XLR signal cable is connected correctly or is damaged.</li> </ol>
LCD display is on, but can't operate the light.	Please check if the LCD display shows "🔒", long press the "LOCK" key for 2s to release the LOCK.
The fan doesn't work	<ol style="list-style-type: none"> <li>1. Please check if the fan is OFF</li> <li>2. If the screen displays "Fan abnormal", please contact place of purchase.</li> </ol>

**What's in the box? Please kindly check.**

Dyno 650C×1	Power Adapter×1	DC Connecting Cable×1	Power Cable×1	Light Stand Clamp×1
				
	USB Flash Drive×1	DMX Channel Chart×1	User Manual×1	
				

Dyno 1200C x 1	Power Adapter×1	DC Connecting Cable×1	Power Cable×1	Light Stand Clamp×1
				
	USB Flash Drive×1	DMX Channel Chart×1	User Manual × 1	
				

This manual and all stats within it were produced under controlled conditions, and are accurate at time of print. Further details about design or technical data updated please visit [www.nanlux.com](http://www.nanlux.com).

Version: V2 2020-12-01

 +86-754-85751187

 +86-754-85300887

 [info@nanlux.com](mailto:info@nanlux.com)

 Zhanglin,324,Dongli Chenghai Shantou Guangdong China

**Guangdong NanGuang Photo&Video Systems Co., Ltd**