

NANLUX

Evolve 900C LED RGBLAC Spot Light

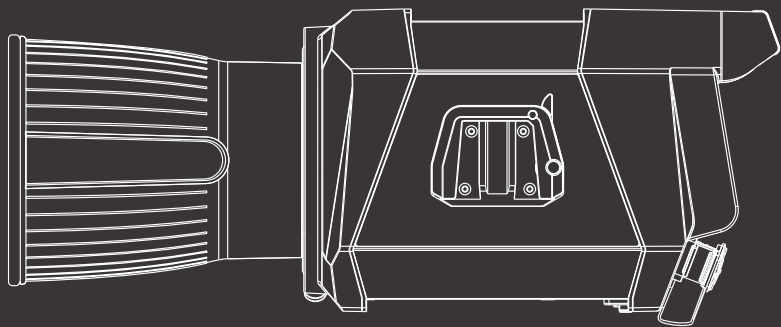

USER MANUAL

Introduction

Thank you for purchasing Nanlux product-Eovke 900C!

Evoke 900C is a high power output, full color spot light with RGBLAC color mixing technology, owning fully adjustable color temperature ranging from 1800K-20000K (G/M±200). It supports CCT, Advanced HSI, XY, RGBW, GEL and EFFECT lighting modes, and on board control, wire control, APP, DMX/RDM, LumenRadio CRMX and Art-Net, sACN controlling modes. Besides, with IP55 rating, adjustable cooling system and various accessories, Evoke 900C can provide great performance and versatile functions in virtual production or other professional projects.

Notice

1. Please do not look directly at the emitter when the light is on, to avoid eyes discomfort caused by high luminance.
2. Please do not place the fixture near any flammables and explosives, to avoid fire hazard caused by high luminance.
3. Please do not immerse the fixture in water. While with IP55 rating, the light fixture can be used in the rainy situations.
4. Please place the power cable and DC cable properly to avoid stumbled caused by long cables.
5. Please exchange the power cable if any damage is found, to avoid electric shock.
6. Please use the power cable and DC cable provided by the manufacturer as the power is high. Dangers like melting cable, electric shock or fire may happen if cables of other brands are used.
7. Please do not block the vents when the fixture is on. The fixture is built with active cooling system, so ensure unimpeded vents to prevent the fixture from protection state due to overheating.
8. Please do not disassemble the fixture to repair at will, so as not to cause damage to the fixture that contains precision electronic components. If repair is required, please return to the distributor or have them repaired by any qualified technician.
9. Please switch the fixture off and unplug the cables before cleaning, to avoid electric shock.
10. Please do not use strong detergent for cleaning. Please wipe off the dirt by using a cloth with neutral cleanser when cleaning the fixture.
11. Please hold the handle securely when detaching the accessories or adjusting the beam directions, since the accessories such as Fresnel lens and softbox are heavy.
12. Please ensure that the power cable and DC cable are properly connected when using the fixture, to avoid sparking and heating of the plug.

Evoked 900C LED RGBLAC Spot Light

Product Diagram

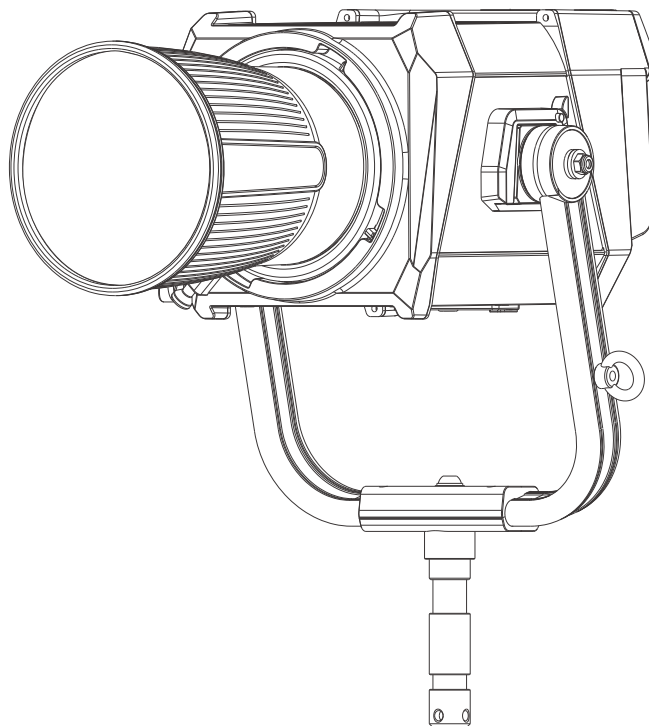

Technical Data

Rated Power: 940W

Input: DC 48V/18.75A Max

AC 100-240V 50/60Hz

Color Temperature: 1800K-20000K (G/M±200)

CRI: Average 96

TLCI: Average 96

Product Details

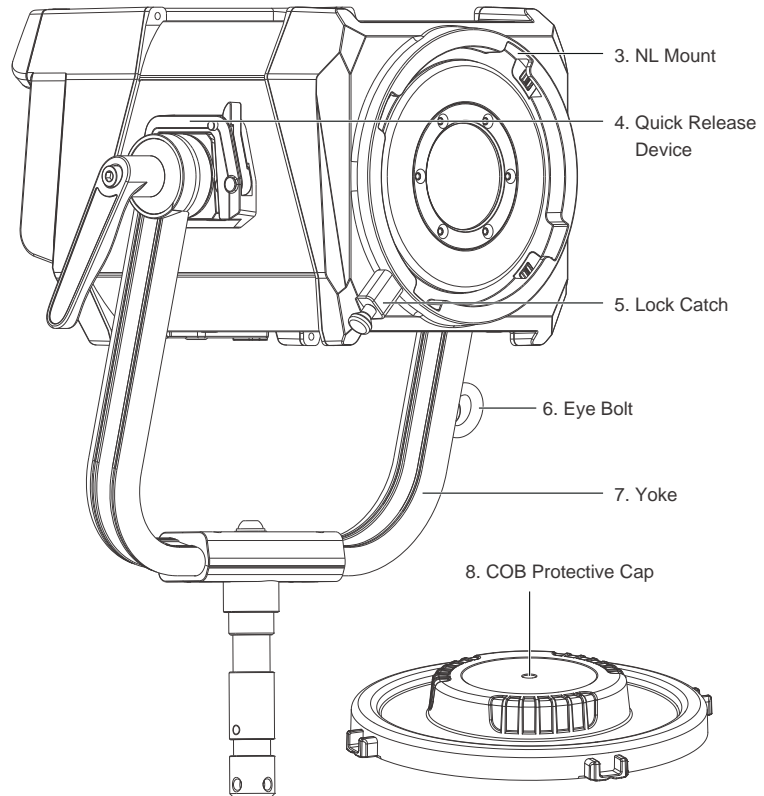
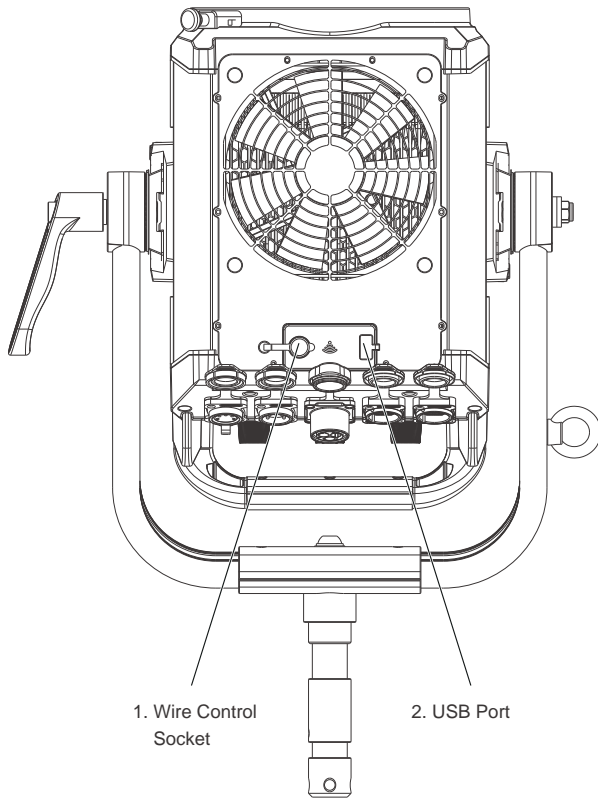

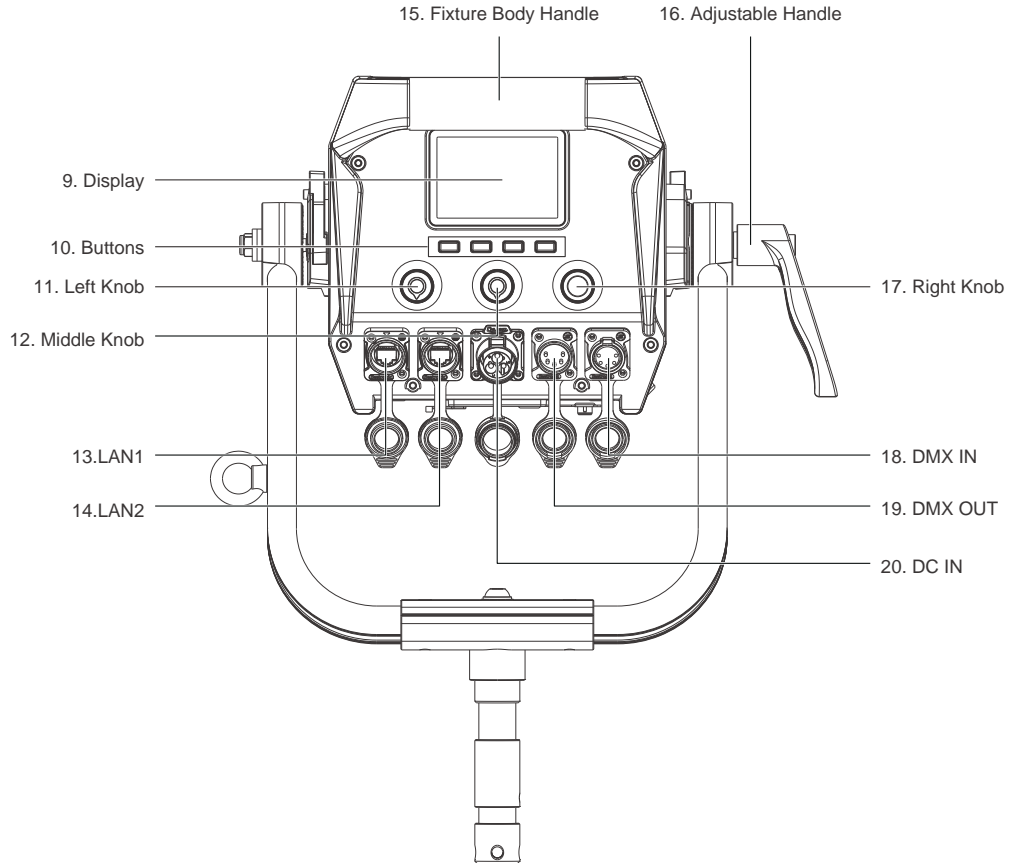

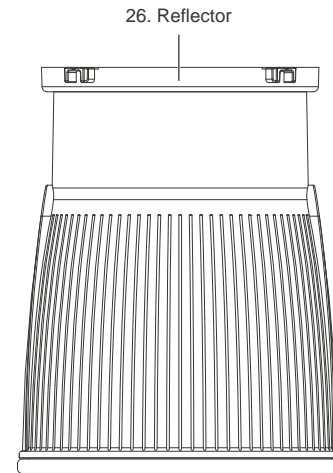
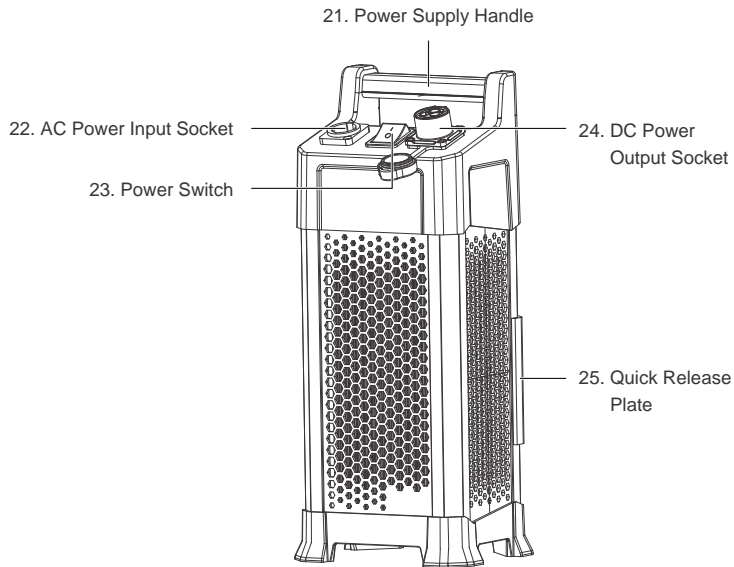





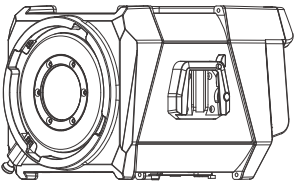

Detailed Description

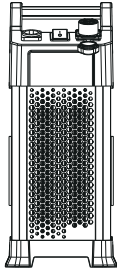
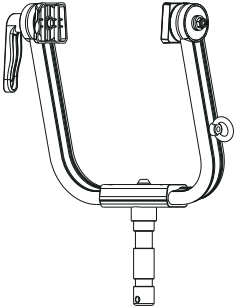
1. Wire control socket: Wire control interface.
2. USB port: For updating firmwares or providing current with maximum 5V/1A to external devices via connecting the USB cable.
3. NL mount: For installing the reflector or other NL mount accessories.
4. Quick release device: For quick installation and detachment of yoke.
5. Lock catch: To lock or release the reflector or other accessories. Note: Please pull in the direction indicated on it.
6. Eye bolt: For hanging safety rope.
7. Yoke: Mount the fixture on a stand, also for pan and tilt.
8. COB protective cap: For protection purpose, please cover the COB with the cap when the fixture is not in use.
(Note: Take off the cap before using.)
9. Display: To display data.
10. Buttons: Including MODE, MENU, PRESET and LOCK.
11. Left knob: For adjusting brightness.
12. Middle Knob: For adjusting settings for each option.
13. LAN 1: Network connecting port.
14. LAN 2: Network connecting port.
15. Fixture body handle: Offer convenient grip for adjusting direction of illumination.
16. Adjustable handle: Tighten or release the tilt movement of the fixture on the yoke.
17. Right knob: For selecting options.
18. DMX IN: DMX signal input interface.
19. DMX OUT: DMX signal output interface.
20. DC IN: DC power input interface.
21. Power supply handle: For lifting the power supply.
22. AC power input socket: For connecting AC cable and supplying power to power supply.
23. Power switch: To turn on/off the fixture.
24. DC power output socket: For connecting the fixture to the power supply with DC cable.
25. Quick release plate: For mounting the quick release clamp.
26. Reflector: For concentrating light to improve the central illumination.

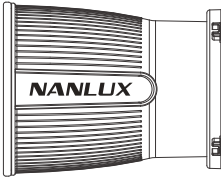
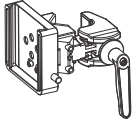
Includes

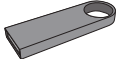
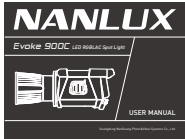
<p>Evoker 900C x 1</p>	<p>DC Connection Cable x 1</p>	<p>AC Power Cable x 1</p>	<p>Power Supply x 1</p>
			
<p>Yoke x 1</p>	<p>CC-ST-EV900C Trolley Case x 1</p>	<p>Reflector x 1</p>	<p>AS-CP-QR-EV x 1</p>
			
		<p>Remote Controller x 1</p>	<p>USB Flash Drive x 1</p>
			
	<p>User Manual x 1</p>		

Multi-light Kit

Carton Packaging

Evoke 900C x 1	AS-CP-QR-EV x 1
Yoke x 1	USB Flash Drive x 1
Power Supply x 1	WS-RC-C2 Remote Controller x 1
Reflector x 1	User Manual x 1
DC Connection Cable 7.5M x 1	
AC Power Cable 6M x 1	

Evoke 900C FL-YK-KIT Flight Case Kit

Evoke 900C x 1	AS-CP-QR-EV x 1
Yoke x 1	FL-35YK Lens x 1
Power Supply x 1	USB Flash Drive x 1
Reflector x 1	WS-RC-C2 Remote Controller x 1
DC Connection Cable 7.5M x 1	User Manual x 1
AC Power Cable 6M x 1	CC-EV1200-FL-YK-FT Flight Case x 1

Evoke 900C Flight Case Kit

Evoke 900C x 1	AS-CP-QR-EV x 1
Yoke x 1	USB Flash Drive x 1
Power Supply x 1	WS-RC-C2 Remote Controller x 1
Reflector x 1	User Manual x 1
DC Connection Cable 7.5M x 1	CC-EV1200-FT Flight Case x 1
AC Power Cable 6M x 1	

Usage

1. Connection Between Light Fixture and Power Supply

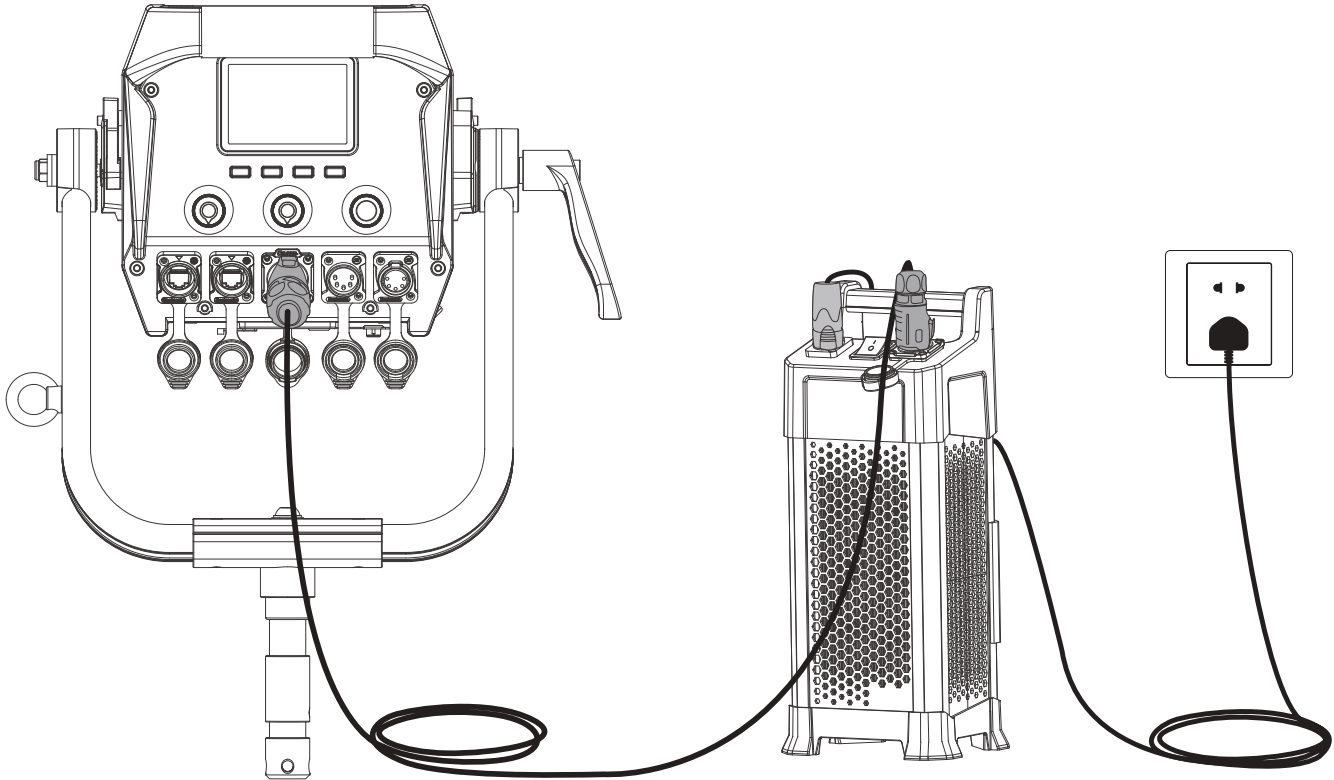

2. Installation and Detachment of Yoke

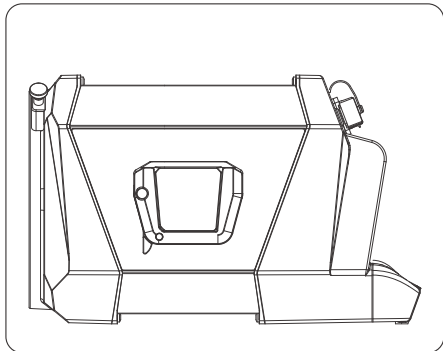

Lay down the light fixture on flat ground, with its bottom up.

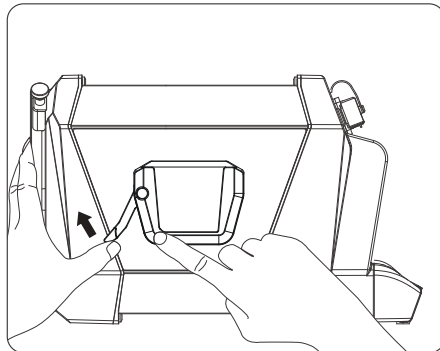

Press the quick release lever lock catch to release the lever, and push the lever aside.

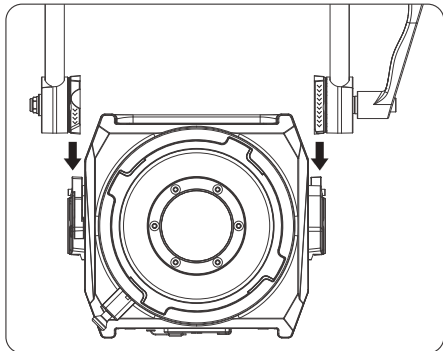

Align and insert the quick release plates to the mounts on both sides of the fixture.

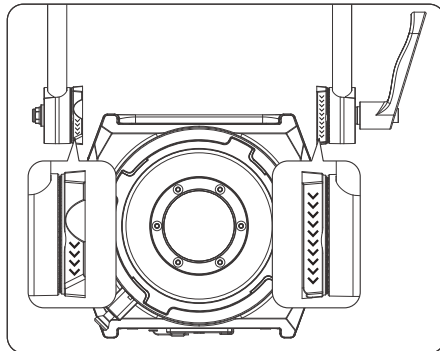

Note: Please adjust the plate to right directions when installing the quick release plate, then insert them into the mount.

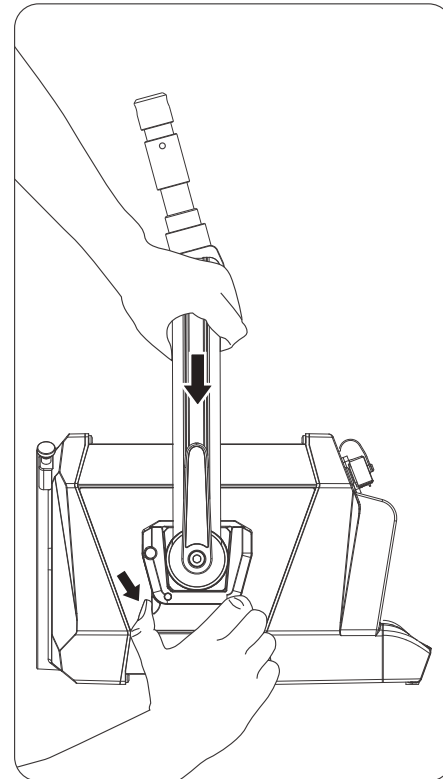

Firmly hold the yoke in place with one hand, and pull the quick release lever with the other hand to lock the plate.

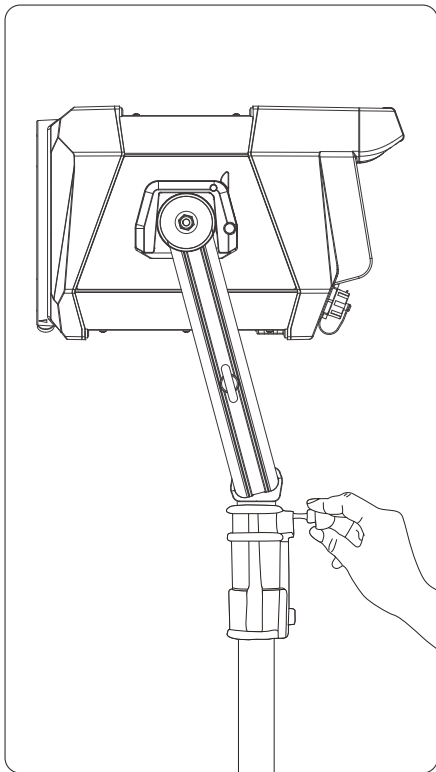

Mount the fixture on heavy-duty light stand and lock the fastening screws on the light stand.

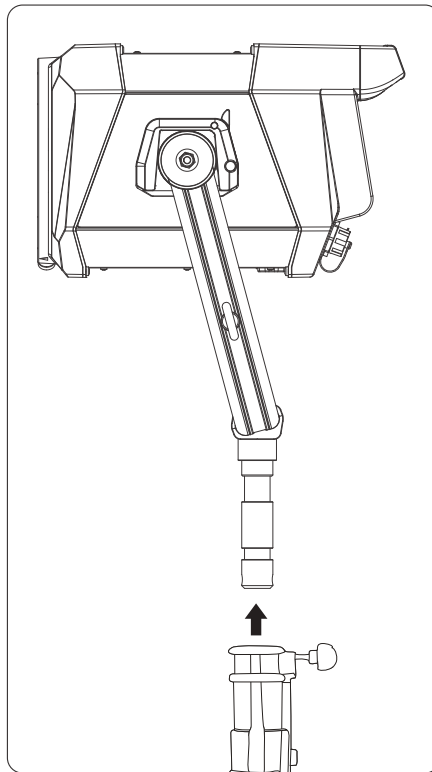

When disassembling the yoke, remove the fixture from the heavy-duty light stand first and lay it down on flat ground.

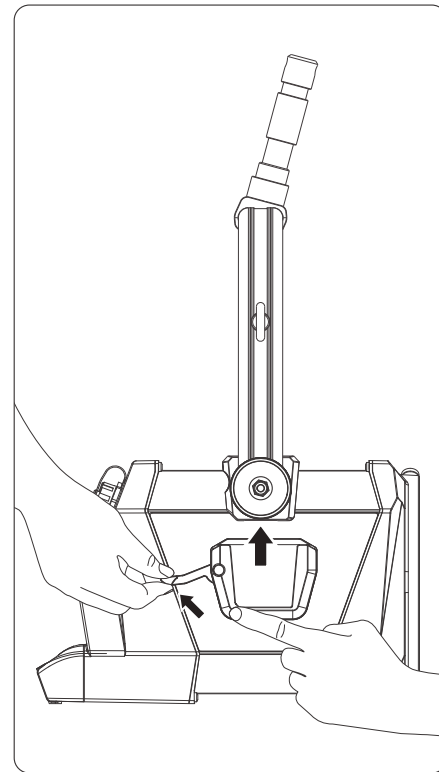

Press the quick release lever lock catch of the fixture on both sides, then release the quick release lever to remove the fixture.

Installation of Yoke (Method Two)

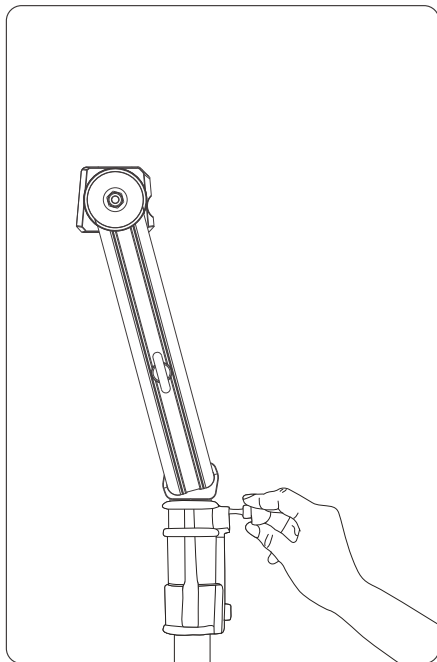

Mount the yoke on heavy-duty light stand and lock the fastening screws on the light stand.

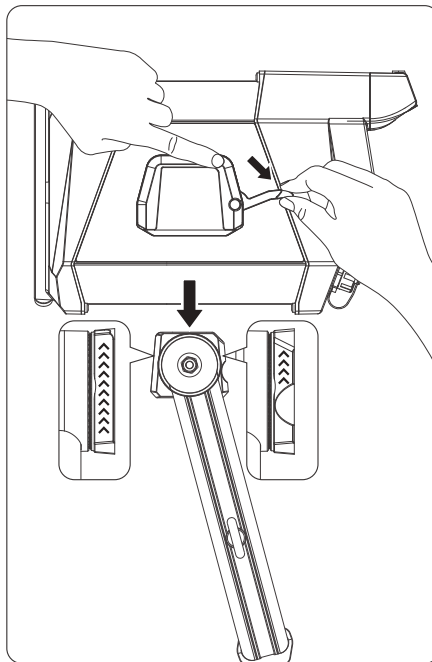

Press the quick release lever lock catch and push the lever aside, align and insert the quick-release plate mounts to the plates of the yoke.

(Note: Please adjust the plate to right directions when installing the quick release plate, then insert them into the mount.)

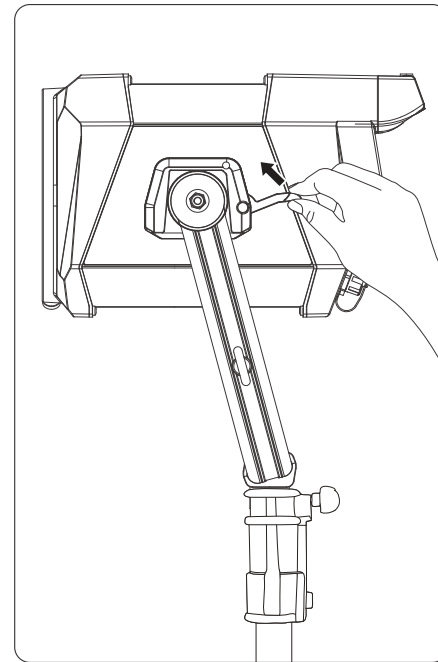

Pull the levers on both sides of the fixture to lock the quick release plate in place. The installation of the yoke is completed.

3. Installation and Detachment of Reflector

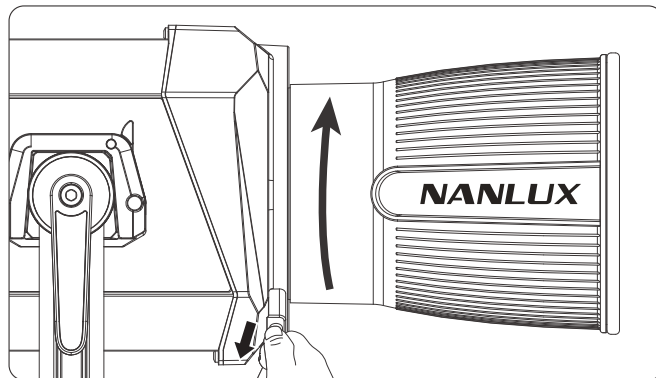
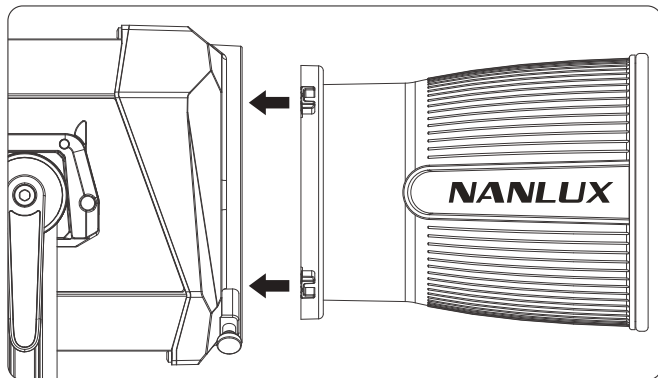

When installing the reflector, align the reflector's bayonet lock to the light's mount, rotate the reflector clockwise and fasten the reflector on the light.
 (Note: if the rotation is not smooth, pull the lock catch of the mount and rotate the reflector at the same time.)

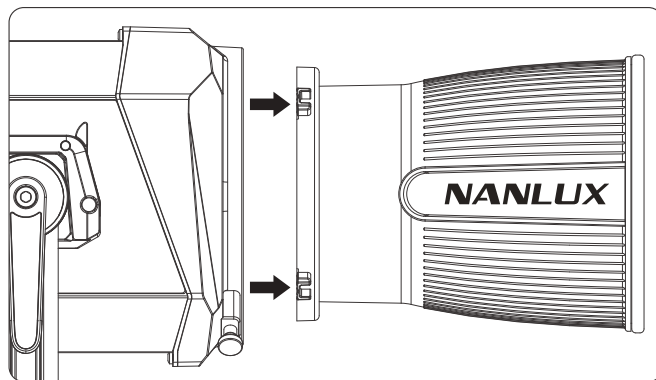
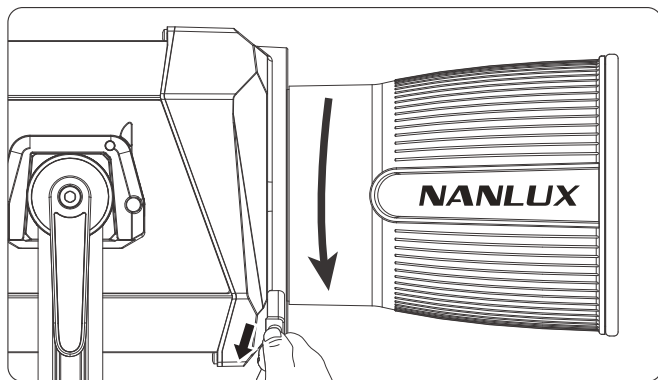

When removing the reflector, pull the lock catch of the mount, rotate the reflector anticlockwise and remove.

4. AS-CP-QR-EV Evoke Quick Release Clamp Installation

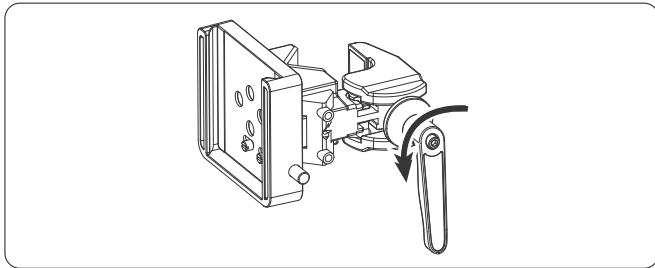

Rotate the adjustable handle to release the clamp.

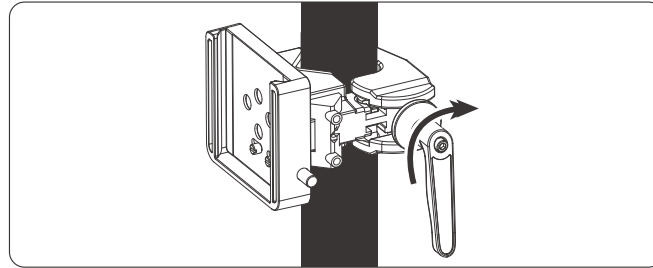

Mount the quick release clamp on the light stand, then rotate the adjustable handle to tighten the clamp.

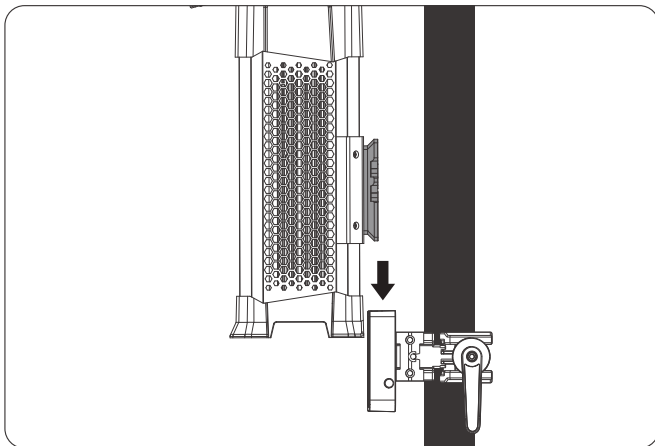

Align the quick release plate on the power supply with the quick release mount on the clamp, a click sound will be heard when the power supply is fastened in place.

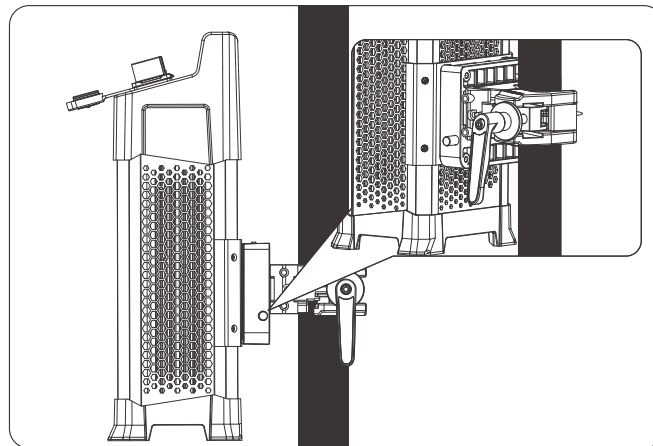

Press the lock catch on the clamp to remove the power supply from the light stand.

Remote Control

· Evoke 900C supports remote control via DMX/RDM, 2.4G, LumenRadio, Art-Net & sACN, and includes a built-in Bluetooth module as well.

▲ The ADDRESS needs to be set before operating the remote control via DMX/RDM, 2.4G, LumenRadio, Art-Net & sACN.

1. ADDRESS/DMX, including ADDRESS, DMX MODE, DMX REDUCED CHANNELS, DMX DIMMING CURVE and DMX SMOOTHING settings.

1.1 ADDRESS

Press MENU button to enter the interface.

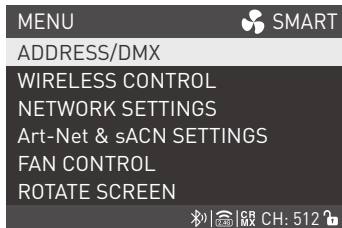

left knob



middle knob



right knob

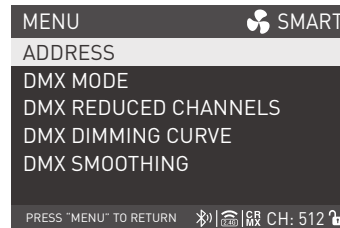
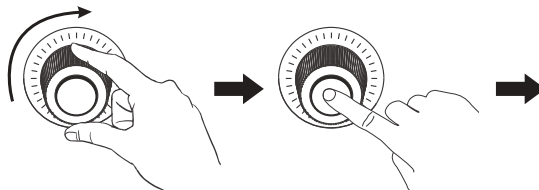
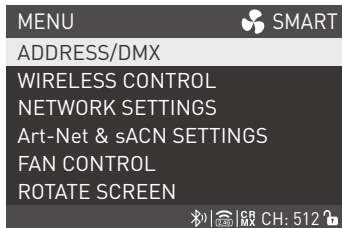
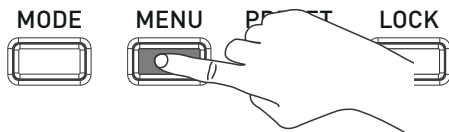

Rotate the "right knob" to ADDRESS/DMX, and press the "right knob" to enter the secondary menu.

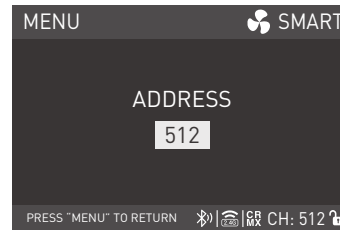
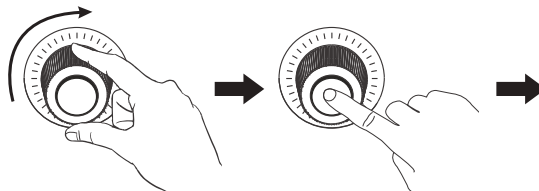
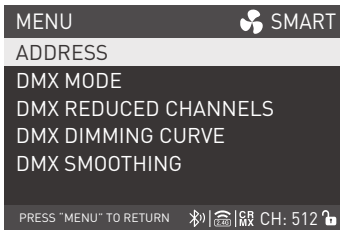

Rotate the "right knob" to ADDRESS, and press the "right knob" to enter the tertiary menu.

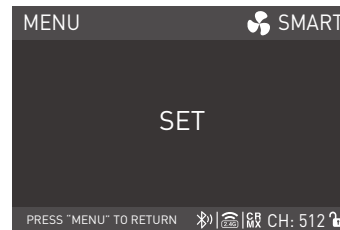
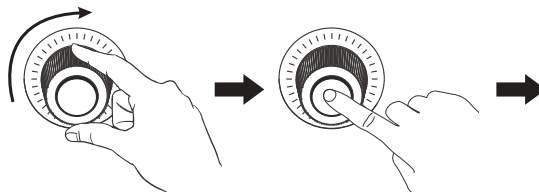
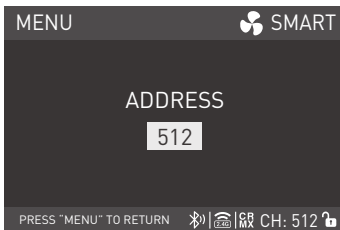

Rotate the "right knob" to select address number and press the "right knob" to set.

NOTE: Evoke 900C has 25 channels, for multiple lights remote control via DMX/RDM and LumenRadio, the address of the first light should be set in 001, the second one in 023, the third one in 045, and so on.

1.2 DMX MODE

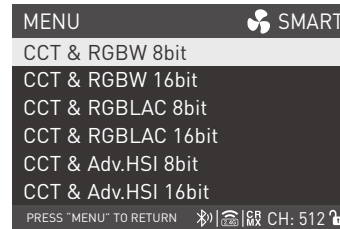
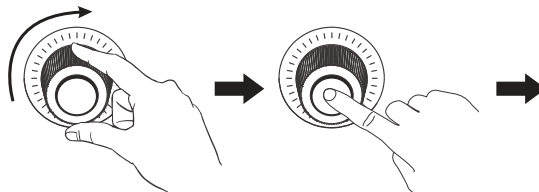
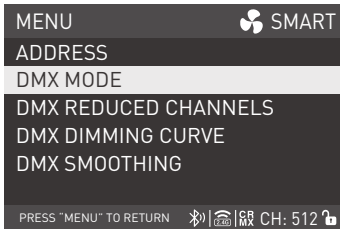

Rotate the "right knob" to DMX MODE and press the "right knob" to enter the tertiary menu.

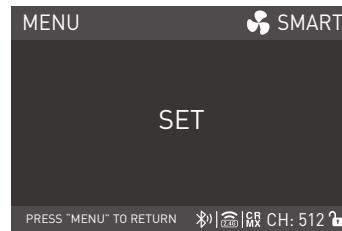
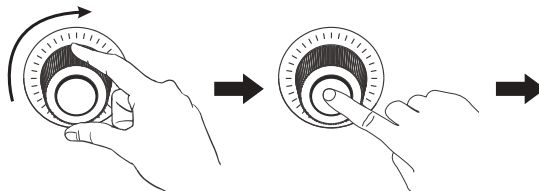
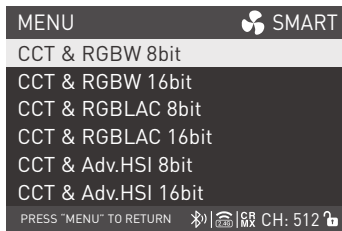

Rotate the "right knob" to select the needed DMX mode, and press the "right knob" to set.

1.3 DMX REDUCED CHANNELS

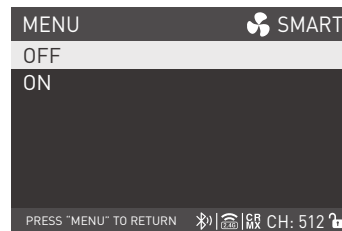
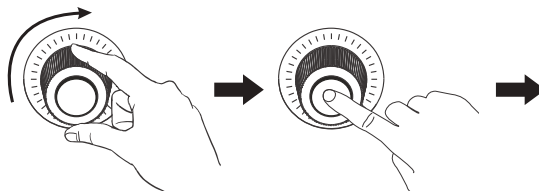
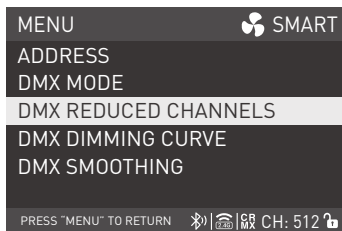

Rotate the "right knob" to DMX REDUCED CHANNELS, and press the "right knob" to enter the tertiary menu.

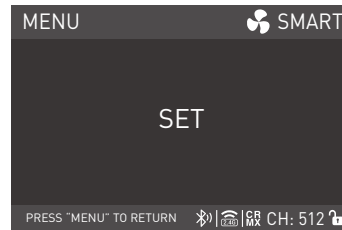
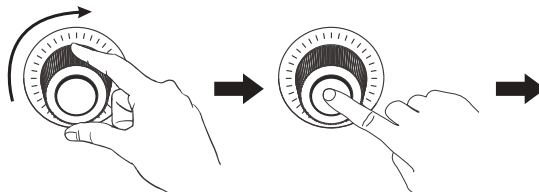

Rotate the "right knob" to select ON or OFF and press the "right knob" to set.

1.4 DMX DIMMING CURVE

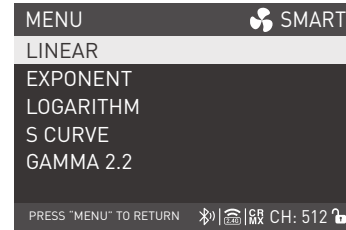
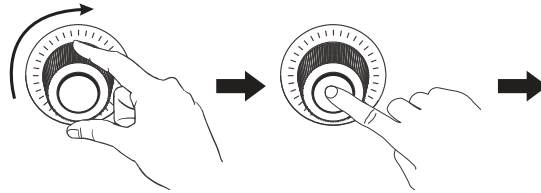
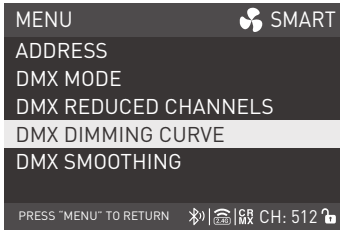

Rotate the "right knob" to DMX DIMMING CURVE, and press the "right knob" to enter the tertiary menu.

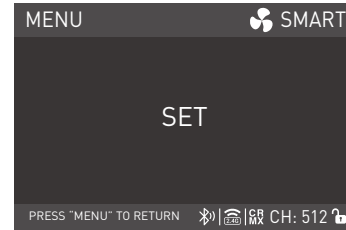
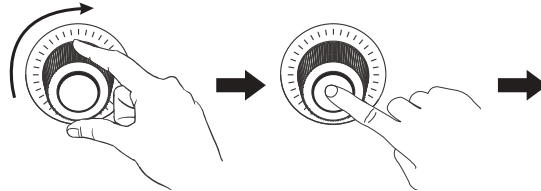
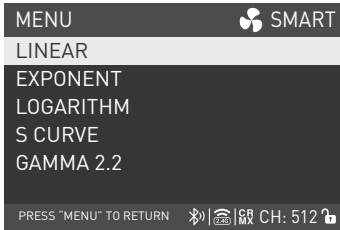

Rotate the "right knob" to select LINEAR, EXPONENT, LOGARITHM, S CURVE or GAMMA 2.2, and press the "right knob" to set.

1.5 DMX SMOOTHING

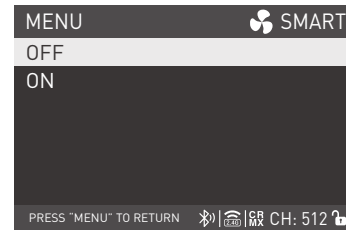
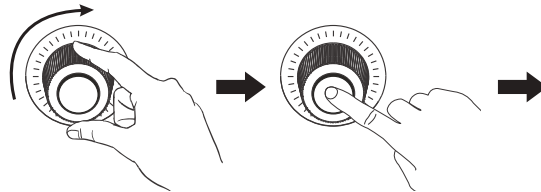
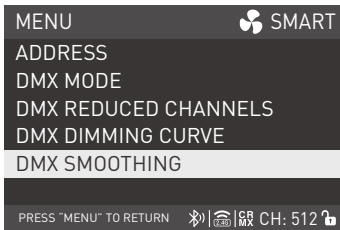

Rotate the "right knob" to DMX SMOOTHING and press the "right knob" to enter the tertiary menu.

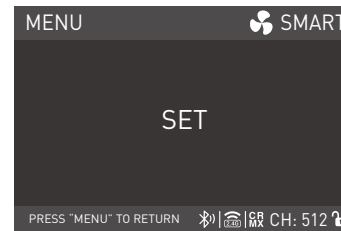
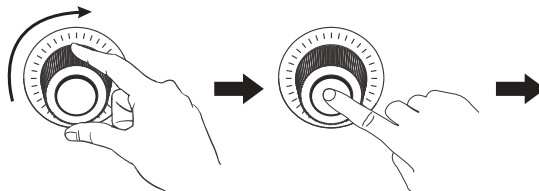

Rotate the "right knob" to select ON or OFF and press the "right knob" to set.

2. DMX Control

2.1. Connect the light fixture and the DMX512 console using the connection cable, as below.



-5-pin shielded cable with a diameter not less than 0.3mm must be used for connection between light fixture and DMX/RDM console, or between light fixture and light fixture. XLR plug/socket and the cable should be connected as picture above.

-Pin1, Pin2, Pin3 for connecting DMX signal. Pin4, Pin5 has no connection.

▲NOTE: When connecting DMX, make sure the internal pin is not in contact with the inner case. The fixture can match the DMX512 (1990) control signal.

-5-pin and 3-pin XLR plug/socket conversion

The fixture comes with 5-pin XLR plug/socket. If a 3-pin XLR plug is used, please follow the instruction below.

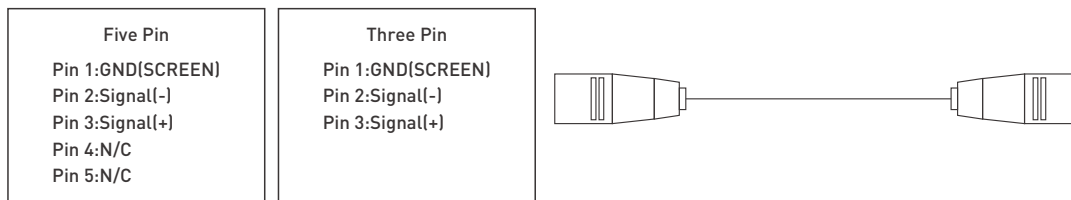

2.2. DMX Terminator

In DMX control mode, the DMX output of the last fixture should be connected with a DMX terminator (Not included). This prevents interference caused by DMX signals in the transmitting process. The terminator is connected with a 120Ω(OHM) resistor across Pin 2 and Pin 3. (As shown below)

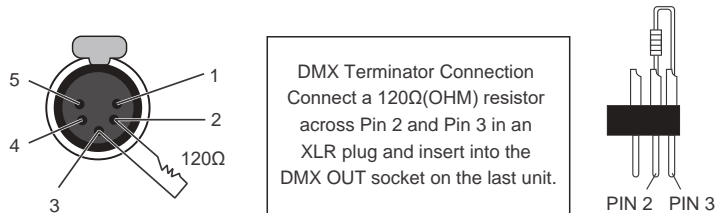

2.3. ADDRESS Setting.

2.4. Refer to the DMX reference guide from www.nanlux.com and control the light via DMX/RDM console.

(For specific operation methods, please refer to the DMX/RDM console operation manual.)

2.5. Note: For technical data, please download from <https://www.nanlux.com/en/h-col-274.html>.

3. RDM Control

3.1. Connect the light fixture to the console with RDM function, the connecting method is the same as that of DMX console.

3.2. Control the fixture via a console with RDM function. (For specific operation instruction, please refer to the RDM console operation manual.)

Note: The UID format of the fixture is as follows:

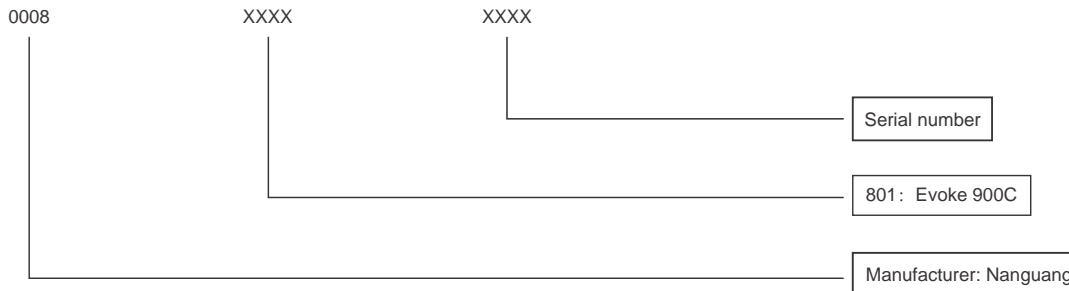

4. WIRELESS CONTROL

4.1 BLUETOOTH Setting

The Evoke 900C has built-in Bluetooth module, so it can be controlled via Bluetooth connection.

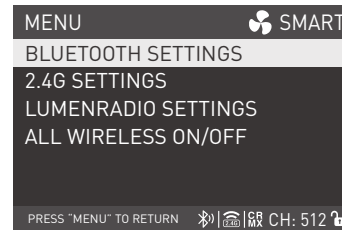
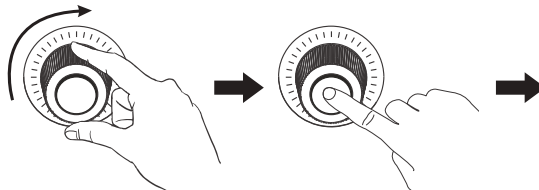
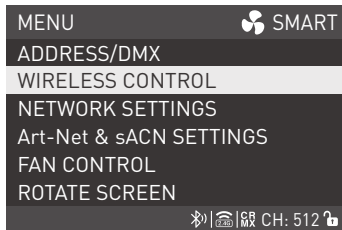

Rotate the "right knob" to WIRELESS CONTROL, and press the "right knob" to enter the secondary menu.

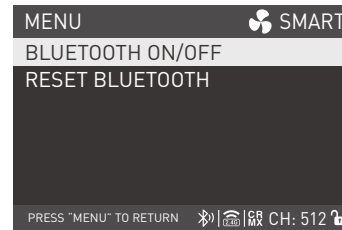
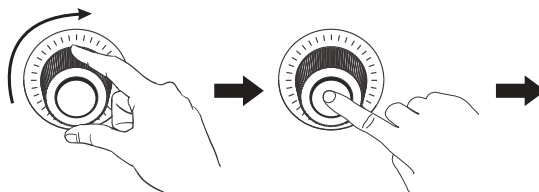
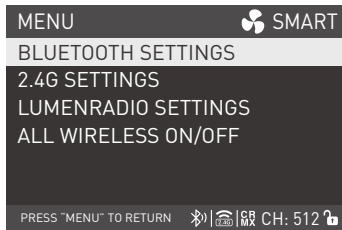

Rotate the "right knob" to BLUETOOTH SETTINGS, and press the "right knob" to enter the tertiary menu.

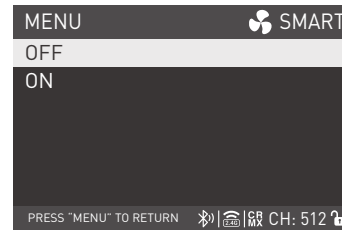
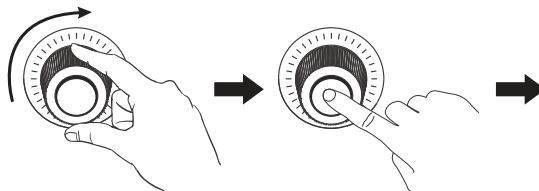
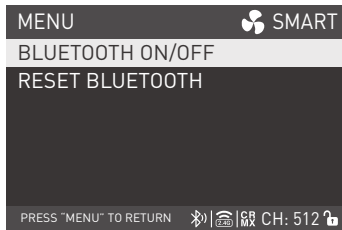

Rotate the "right knob" to BLUETOOTH ON/OFF, and press the "right knob" to enter the next level menu.

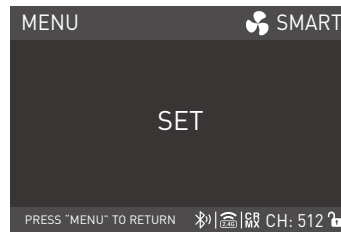
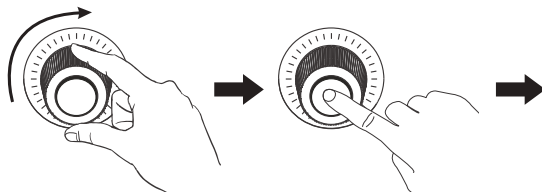

Rotate the "right knob" to select ON or OFF, and press the "right knob" to set.
The RESET BLUETOOTH is available when the Bluetooth is on.

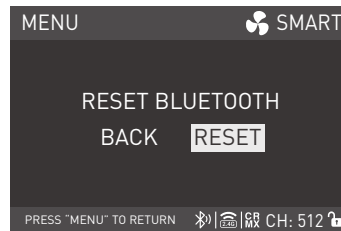
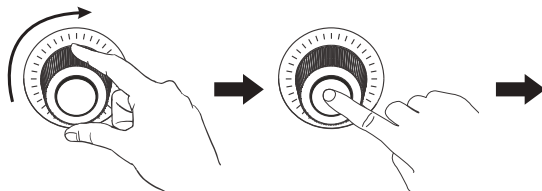
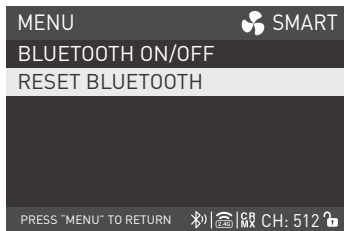

Rotate the "right knob" to RESET BLUETOOTH, and press the "right knob" to enter the next level menu.

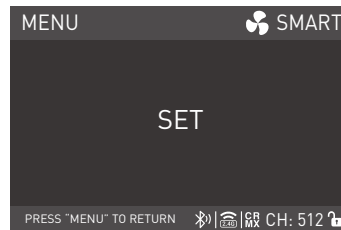
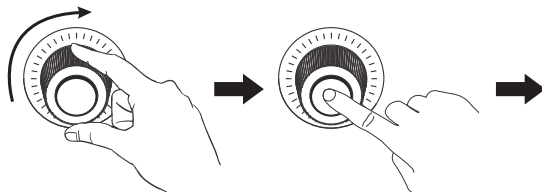
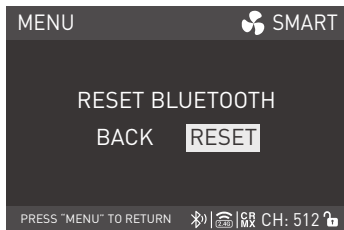

Rotate the "right knob" to select RESET, and press the "right knob" to set.

4.2 2.4G Setting

· Evoke 900C can be remotely controlled by 2.4G remote controller or by NANLINK APP via WS-TB-1 transmitter box.

Note:①2.4G remote controller and NANLINK transmitter box are sold separately.

②The fixture supports 2.4G wireless protocol V1.0 and V2.0. The fixture should be set in V2.0 while using WS-RC-C2 remote controller, set in V1.0 while using other remote controllers.

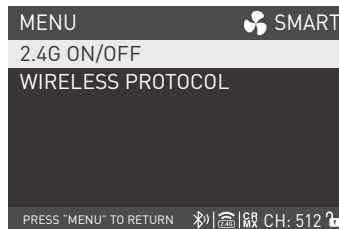
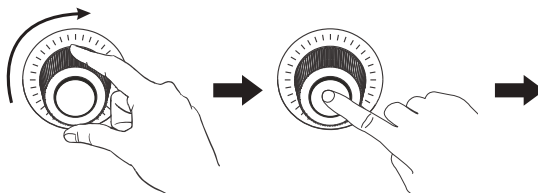
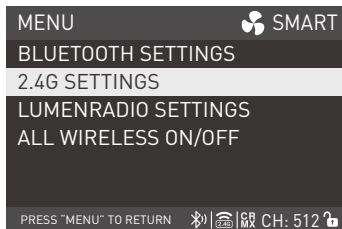

Rotate the "right knob" to 2.4G SETTINGS, and press the "right knob" to enter the tertiary menu.

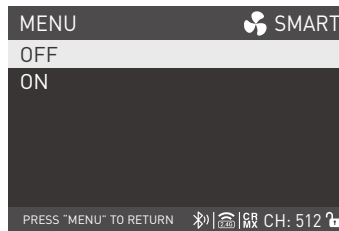
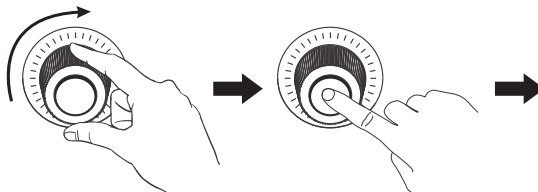
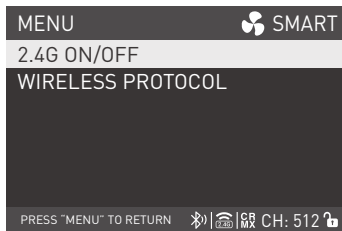

Rotate the "right knob" to 2.4G ON/OFF, and press the "right knob" to enter the next level menu.

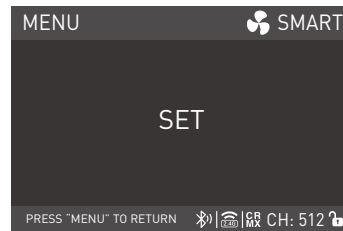
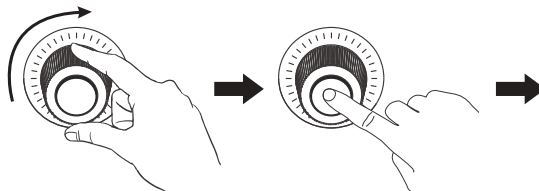
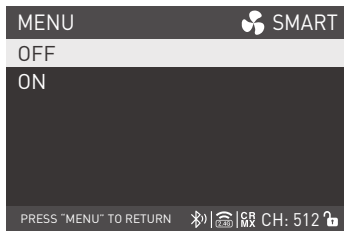

Rotate the "right knob" to select ON or OFF, and press the "right knob" to set. The 2.4G wireless control is available when the 2.4G is set to be on.

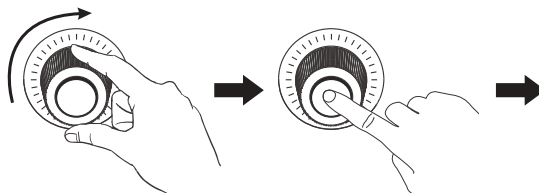
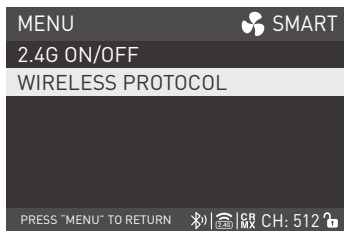

Rotate the "right knob" to WIRELESS PROTOCOL, and press the "right knob" to enter the next level menu.

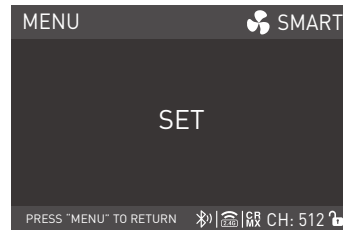
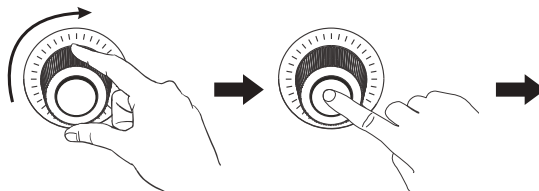

Rotate the "right knob" to select V1.0 or V2.0, and press the "right knob" to set.

4.3 LUMENRADIO Setting

Evoke 900C has built-in CRMX TIMOTWO module, enabling it to receive and send CRMX wireless DMX signals. The specific operations are as below: press MENU to enter the interface.

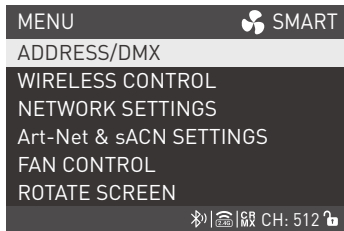

left knob



middle knob



right knob

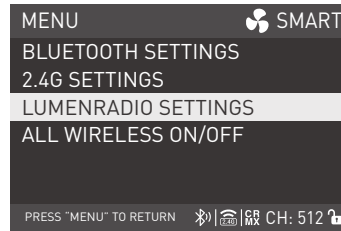
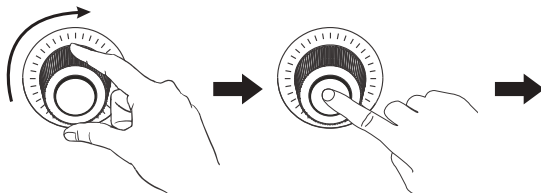
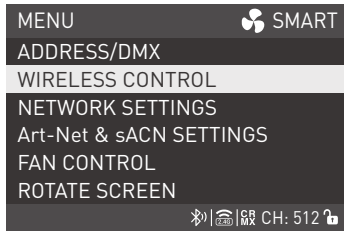
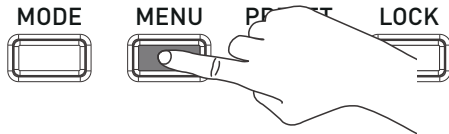

Rotate the "right knob" to WIRELESS CONTROL, and press the "right knob" to enter the secondary menu.

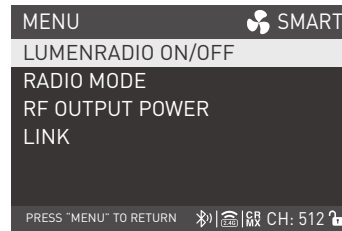
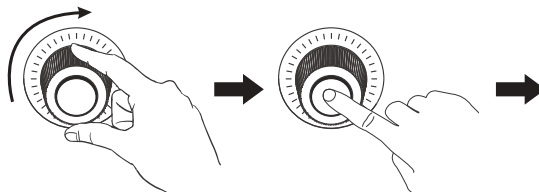
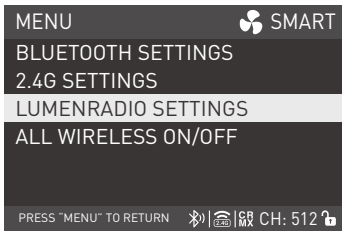

Rotate the "right knob" to LUMENRADIO SETTINGS, and press the "right knob" to enter the tertiary menu.

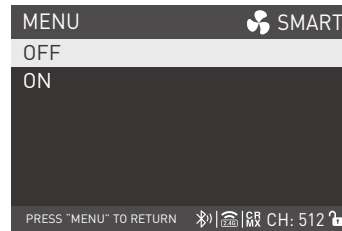
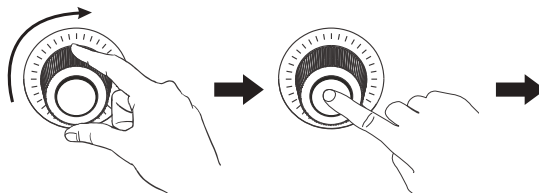

Rotate the "right knob" to LUMENRADIO ON/OFF, and press the "right knob" to enter the next level menu.

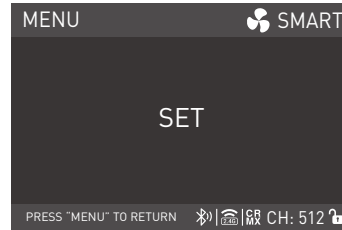
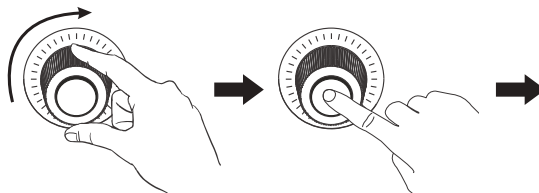

Rotate the "right knob" to select ON or OFF, and press the "right knob" to set.

CRMX wireless DMX signals can be received and transmitted when the LUMENRADIO is set to be on.

① RECEIVER MODE

· RATIO MODE Setting

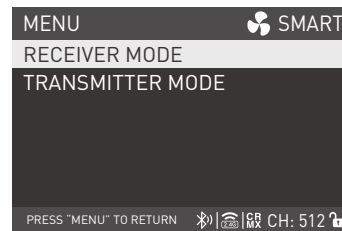
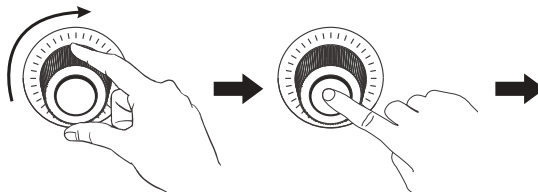
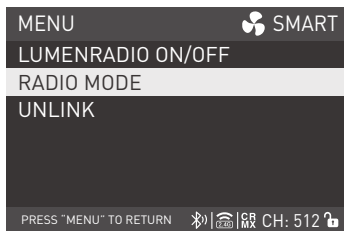

Rotate the "right knob" to RADIO MODE, and press the "right knob" to enter the next level menu.

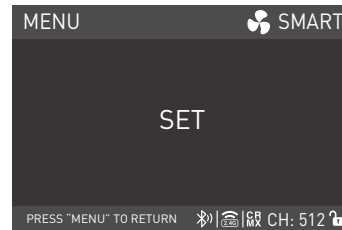
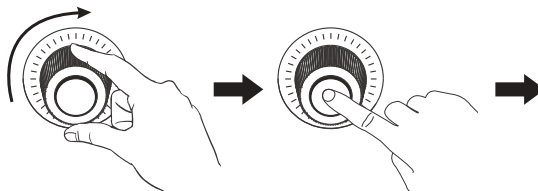
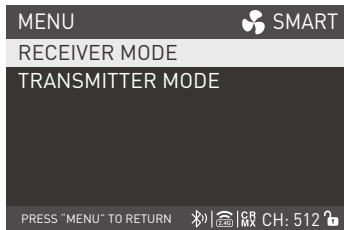

Rotate the "right knob" to select RECEIVER MODE, and press the "right knob" to set.

· UNLINK Setting

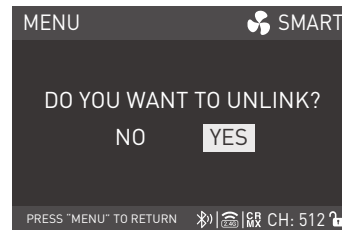
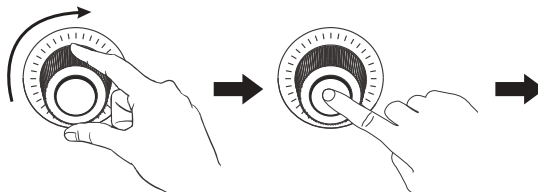

Rotate the "right knob" to UNLINK, and press the "right knob" to enter the next level menu.

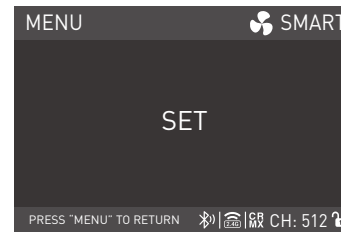
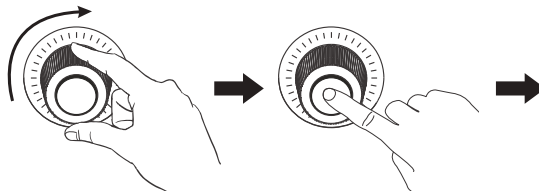
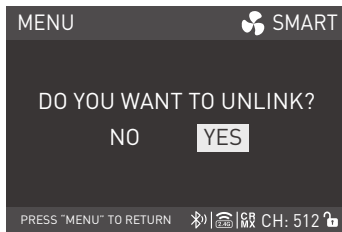

Rotate the "right knob" to select YES, and press the "right knob" to set.

- Please refer to P28 of this manual or CRMX wireless DMX transmitter manual, to connect the fixture set in TRANSMITTER MODE or CRMX wireless DMX transmitter with the fixture set in RECEIVER MODE, the fixture will be able to receive CRMX wireless DMX signals for remote control.

Note: (1) CRMX wireless DMX transmitter is sold separately.

(2) In RECEIVER MODE, the LUMENRADIO SETTINGS should be set to UNLINK to allow it to be reconnected to the new fixtures or transmitters.

② TRANSMITTER MODE

Set the fixture to TRANSMITTER MODE, and connect with the DMX/RDM console.

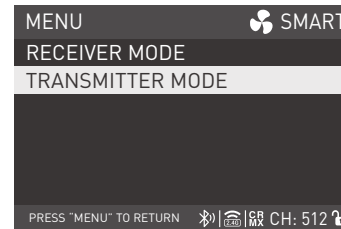
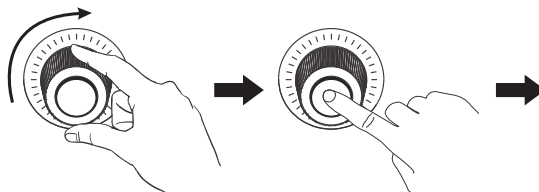

Rotate the "right knob" to RADIO MODE, and press the "right knob" to enter the next level menu.

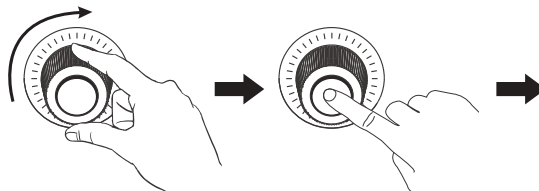
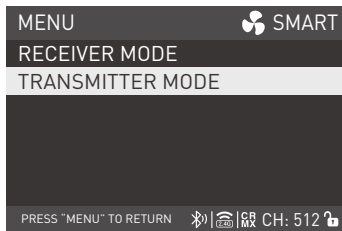

Rotate the "right knob" to select TRANSMITTER MODE and press the "right knob" to set.

The fixture can set the RF OUTPUT POWER when it is in TRANSMITTER MODE, the setting methods are as below:

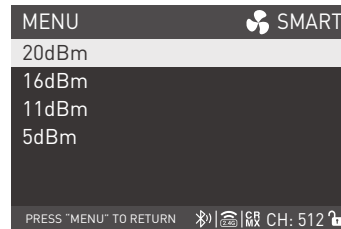
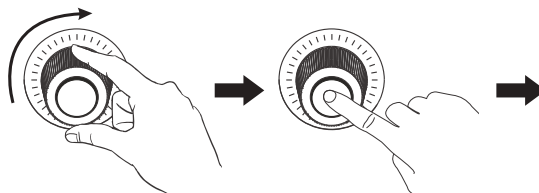
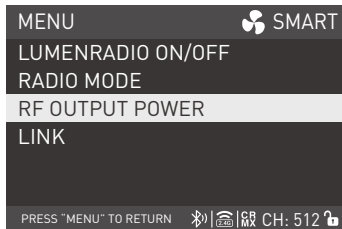

Rotate the "right knob" to RF OUTPUT POWER, and press the "right knob" to enter the next level menu.

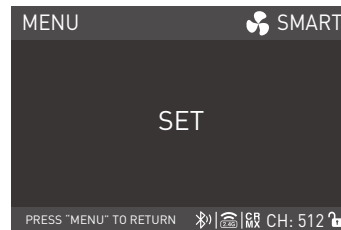
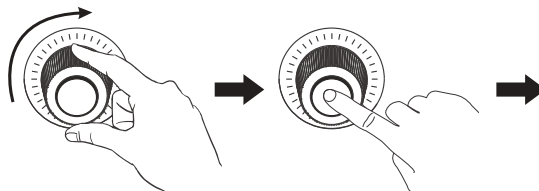

Rotate the "right knob" to select 20dBm, 16dBm, 11dBm or 5dBm, and press the "right knob" to set.

③ Set other fixtures that need to receive CRMX wireless DMX signals to RECEIVER MODE and set to UNLINK. (For setting method, please refer to P28.)

Note: The controlling range of Nanlink Bluetooth and 2.4G remote control will be shortened when set to TRANSMITTER MODE.

④ Connect the fixture set in TRANSMITTER MODE with the fixture set in RECEIVER MODE.

In TRANSMITTER MODE, the signal from the DMX/RDM console or DMX-based APP will be transmitted to the fixtures set in RECEIVER MODE. The fixtures set in TRANSMITTER MODE should be set as below:

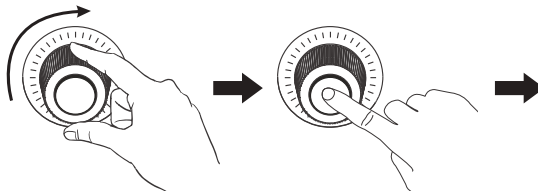
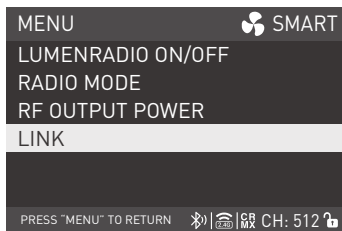

Rotate the "right knob" to LINK, and press the "right knob" to enter the next level menu.

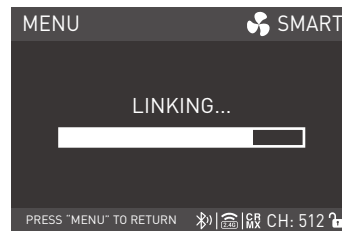
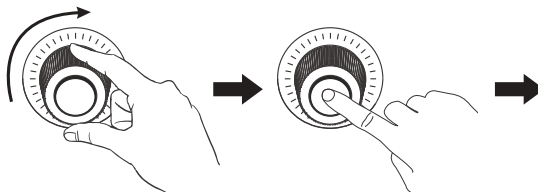
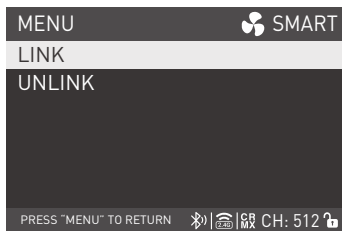

Rotate the "right knob" to select LINK, and press the "right knob" to set.

⑤ UNLINK Setting

When the fixture needs to stop transmitting the CRMX wireless DMX signal, set the fixture to UNLINK. The setting method is the same as the UNLINK setting on P28.

4.4 ALL WIRELESS ON/OFF

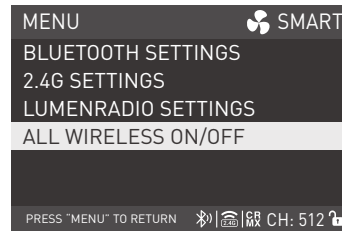
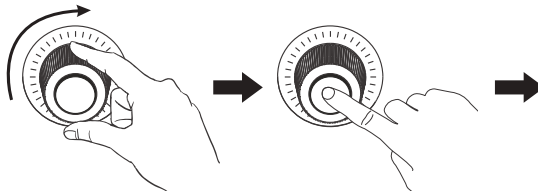
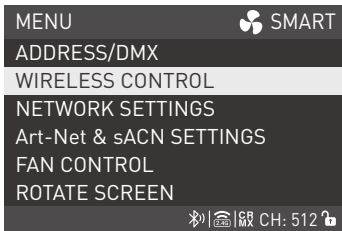

Rotate the "right knob" to WIRELESS CONTROL, and press the "right knob" to the secondary menu.

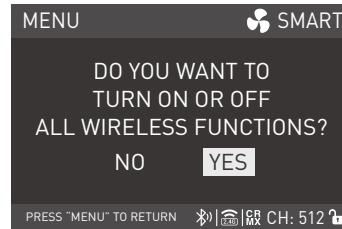
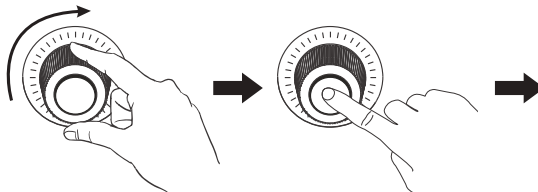
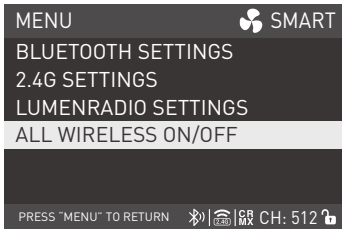

Rotate the "right knob" to ALL WIRELESS ON/OFF, and press the "right knob" to the tertiary menu.

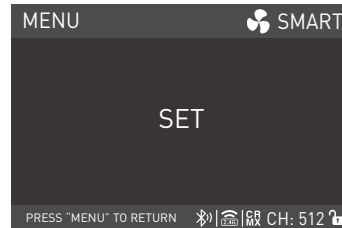
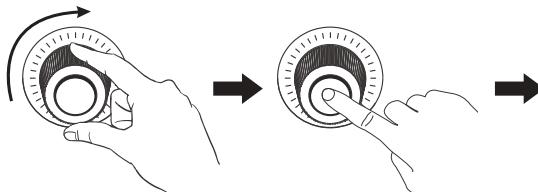
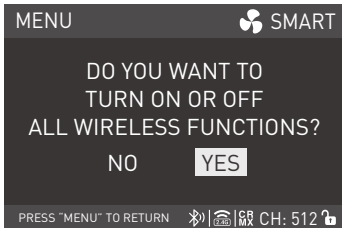

Rotate the "right knob" to select ON or OFF, and press the "right knob" to set.

When all wireless functions are set to be on, all the Bluetooth, 2.4G and LUMENRADIO settings will be in the ON state.

4.5 Art-Net & sACN Setting

① Art-Net & sACN

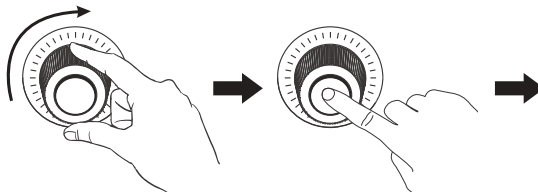
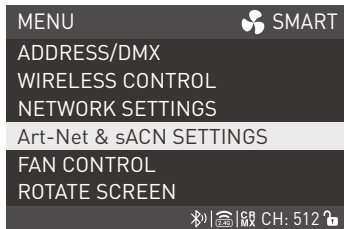

Rotate the "right knob" to Art-Net & sACN SETTINGS.

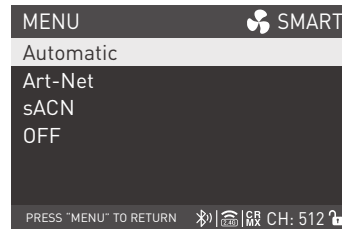
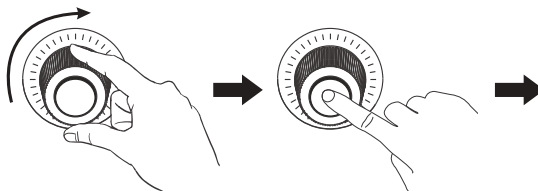

Rotate the "right knob" to Art-Net / sACN STATE, and press the "right knob" to the tertiary menu.

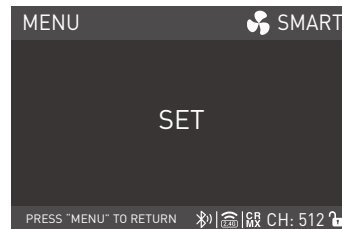
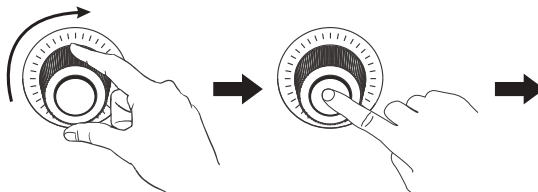

Rotate the "right knob" to select Automatic, Art-Net, sACN or OFF, Press the "right knob" to set.

② Art-Net UNIVERSE Setting

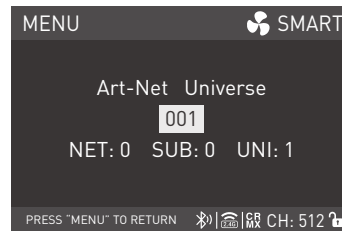
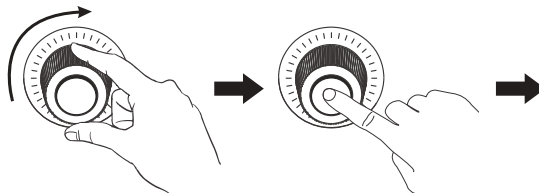
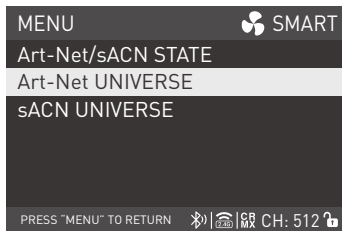

Rotate the "right knob" to Art-Net UNIVERSE, and press the "right knob" to the tertiary menu.

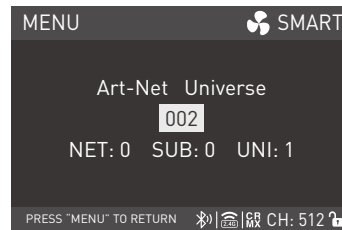
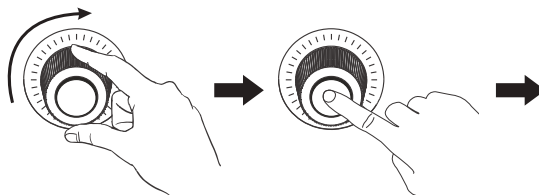
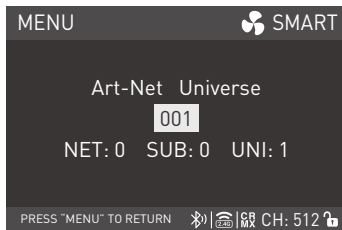

Rotate the "right knob" to select the needed Art-Net Universe value.

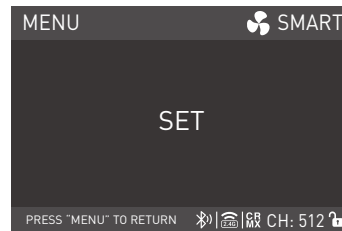
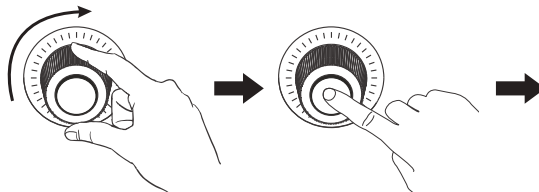
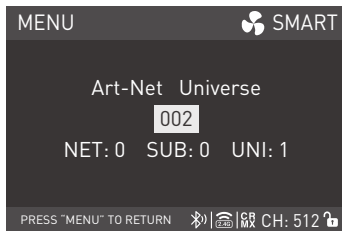

Press the "right knob" to set.

③sACN UNIVERSE Setting

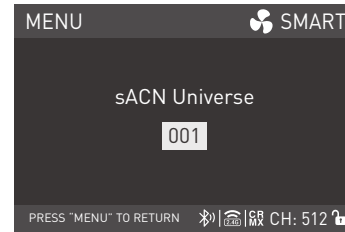
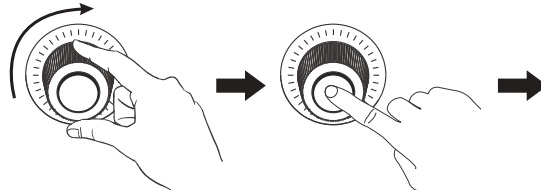
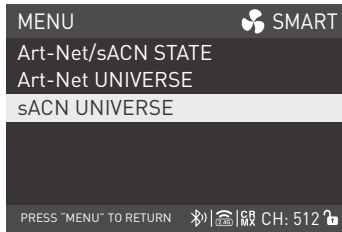

Rotate the "right knob" to sACN UNIVERSE, and press the "right knob" to the tertiary menu.

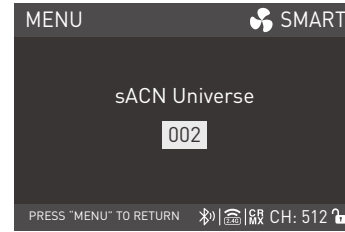
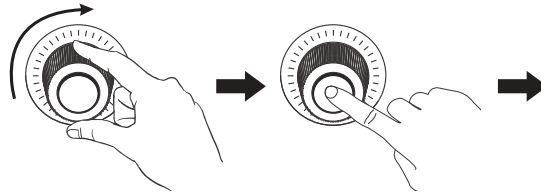

Rotate the "right knob" to select the needed sACN Universe value.

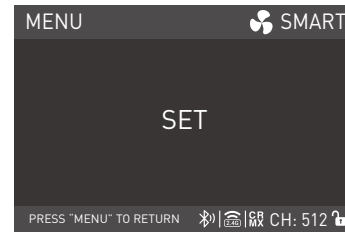
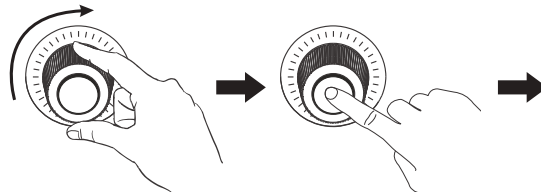

Press the "right knob" to set.

Operating Instructions

1. Make sure the power is off, then connect the power supply with cable and switch it on. If the power indicator is on that means the power input is normal, the screen will display "NANLUX".
2. MODE button: Press the MODE button to enter the lighting mode interface. (The lighting modes include CCT, Advanced HSI, XY Coordinates, RGBW, GEL and Effect modes.)



Press the MODE button to enter one lighting mode.

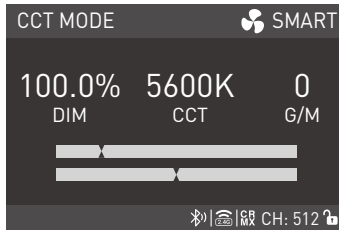
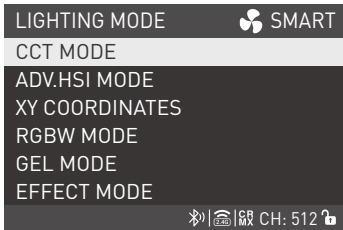

Press the MODE button again to return to the lighting mode list interface.

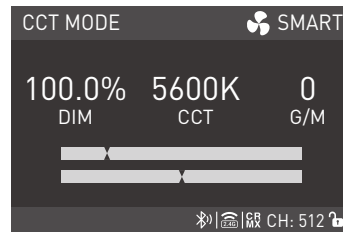
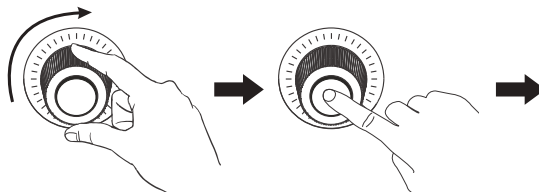
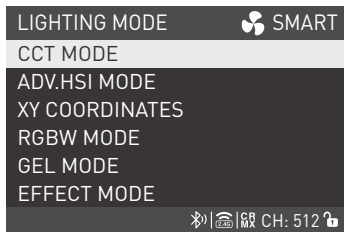

Rotate the "right knob" to select the needed lighting mode, and press the "right knob" to enter the corresponding lighting mode.

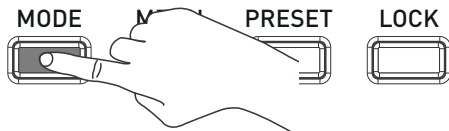
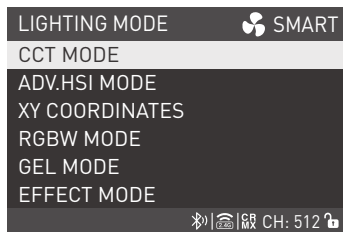
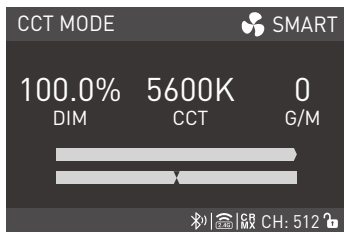

Press the MODE button again to return to the lighting mode list interface.

2.1 CCT Mode

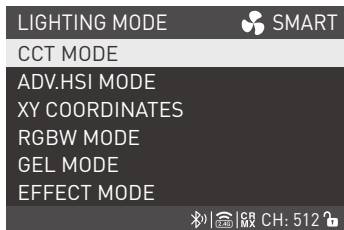

left knob



middle knob



right knob



Press the MODE button to enter the lighting mode list interface.

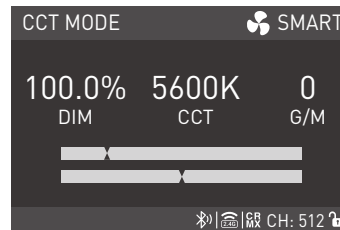
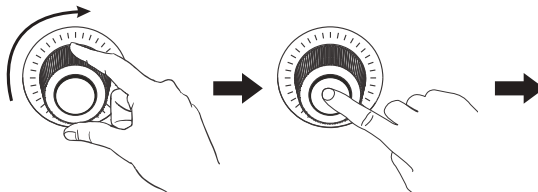
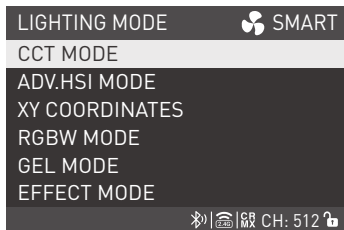

Rotate the "right knob" to CCT MODE, and press the "right knob" to enter the interface.

① Brightness Setting: rotate the "left knob", clockwise to increase brightness while counterclockwise to reduce the brightness. The screen shows the percentage of brightness, DIM range: 0.0-100.0%.

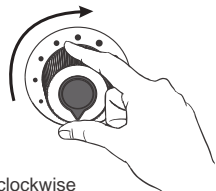
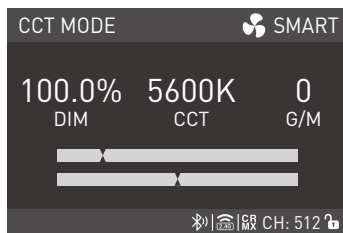

clockwise

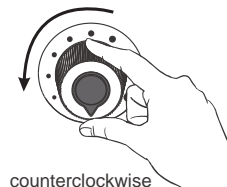
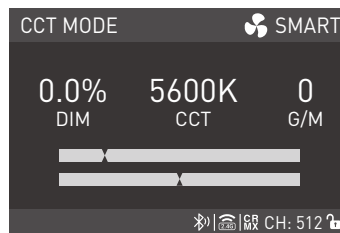

counterclockwise

Note: In other modes, the brightness adjustment range is the same as in CCT mode. When the fixture function is not locking, in any mode, press the "left knob", the fixture is off, the brightness percentage on the screen will be 0.0%, press again, the fixture restores the previous state, press continuously to switch the fixture between on and off.

② CCT Setting: rotate the "middle knob", clockwise to increase color temperature while counterclockwise to reduce the color temperature. The screen shows the CCT value and the corresponding lighting state, range from: 1800K-20000K.

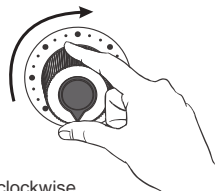
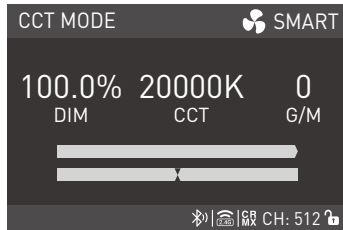

clockwise

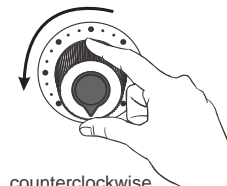
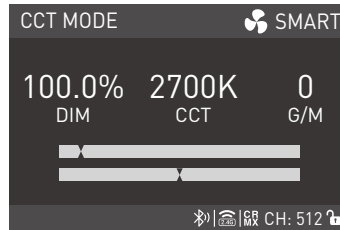

counterclockwise

Note: In other modes, the CCT adjustment range is the same as in CCT mode. Press the "middle knob" to promptly switch among 2700K, 3200K, 4300K, 5600K, 6500K, 7500K, 8500K, 10000K, 12000K, 14000K, 16000K, 18000K and 20000K, which can be adjusted circularly.

③ G/M Setting: rotate the "right knob", clockwise to increase G/M value while counterclockwise to reduce the G/M value. The screen shows the G/M value and the corresponding lighting state, range from: -200...+200.

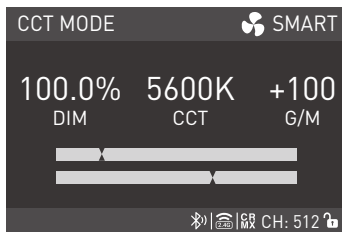

clockwise

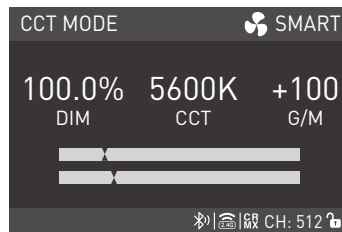

counterclockwise

Note: (1) In other modes, the G/M adjustment range is the same as in CCT mode.

(2) In CCT mode, press the "right knob" to promptly reset the G/M to 0.

2.2 Advanced HSI Mode

Advanced HSI Mode Setting: rotate the "left knob" to adjust the brightness, rotate the "right knob" to select HUE (range: 1-360) , SAT (range: 0%-100%) or CCT, and rotate the "middle knob" to set the parameters.

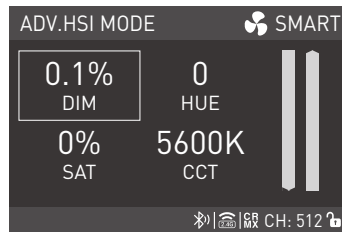
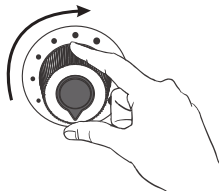
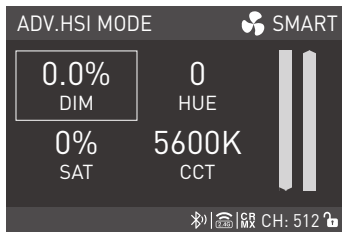

Rotate the "left knob" to adjust the brightness.

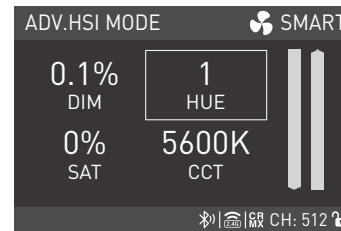
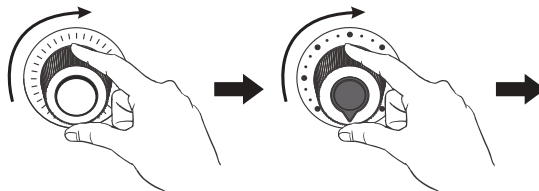
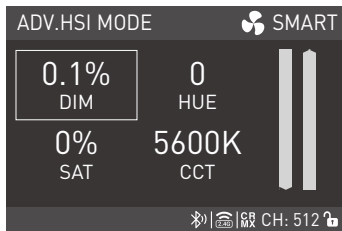

Rotate the "right knob" to select HUE, SAT or CCT, and rotate the "middle knob" to set the parameters.

Note: In other modes, the adjustment range of HUE and SAT are the same as in Advanced HSI Mode.

2.3 XY Coordinates Mode

XY Coordinates Mode Setting: rotate the "left knob" to adjust the brightness, rotate the "middle knob" to adjust the X coordinate value, rotate the "right knob" to adjust the Y coordinate value. By adjusting X and Y coordinate values, Evoke 900C will provide light corresponding to the colors in the CIE1931 color space.

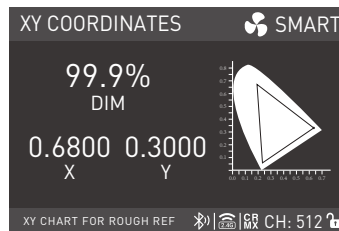
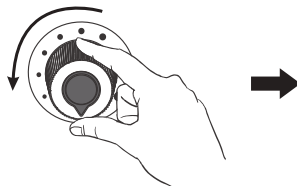
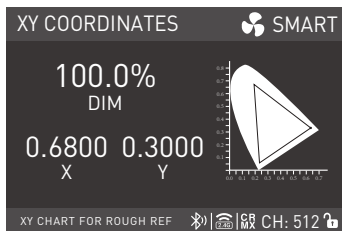

Rotate the "left knob" to adjust the brightness.

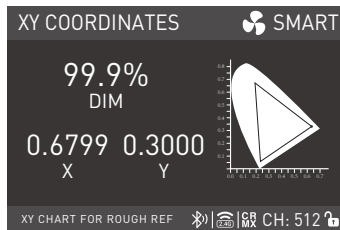
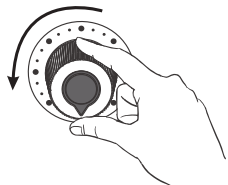
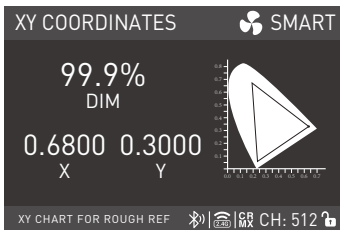

Rotate the "middle knob" to adjust the X coordinate value.

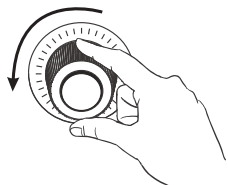
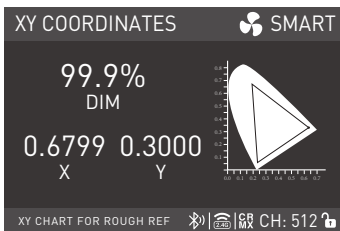

Rotate the "right knob" to adjust the Y coordinate value.

2.4 RGBW Mode

RGBW Mode Setting: rotate the "left knob" to adjust the brightness, rotate the "right knob" to select red, green, blue or white, and rotate the "middle knob" to adjust the corresponding value, range from: 0-255, for both red, green, blue and white option.

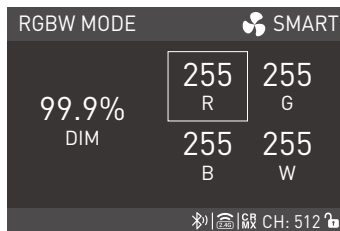
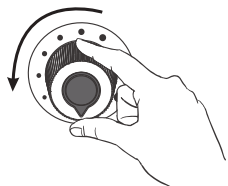
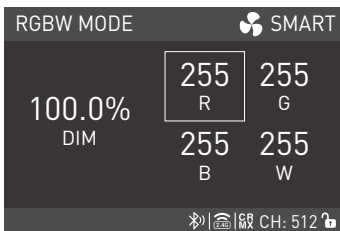

Rotate the "left knob" to adjust the brightness.

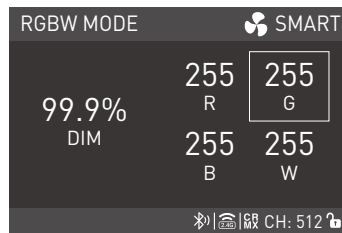
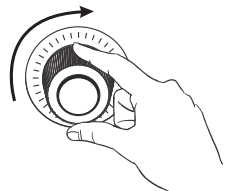
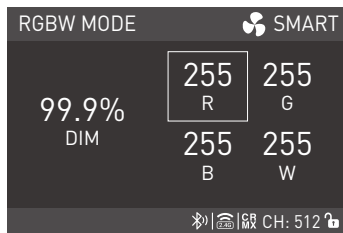

Rotate the "right knob" to select red, green, blue or white.

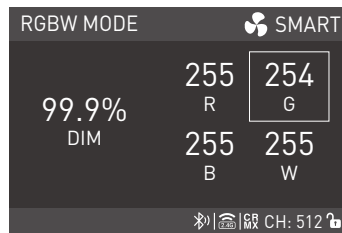
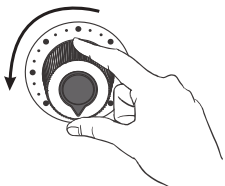
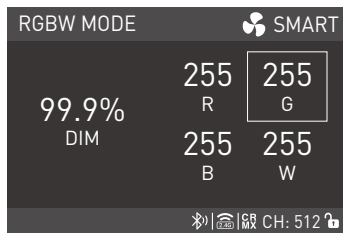

Rotate the "middle knob" to adjust the corresponding red, green, blue and white value.

2.5 Gel Mode

Gel Mode Setting: rotate the "left knob" to adjust the brightness, rotate the "middle knob" to choose 3200K or 5600K, and rotate the "right knob" to select the needed gel.

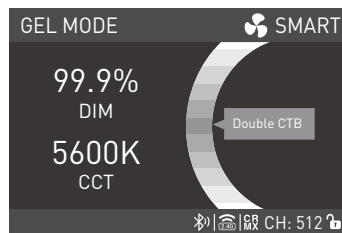
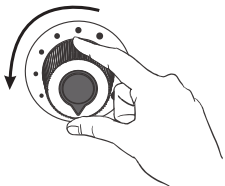
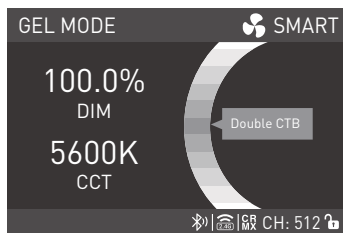

Rotate the "left knob" to adjust the brightness.

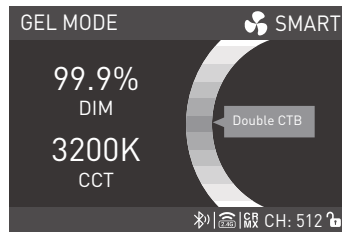
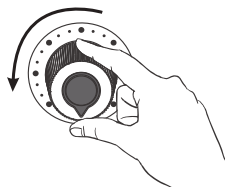
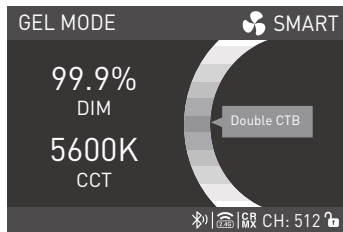

Rotate the "middle knob" to choose 3200K or 5600K.

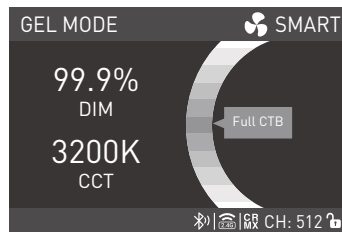
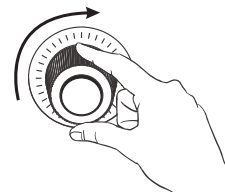
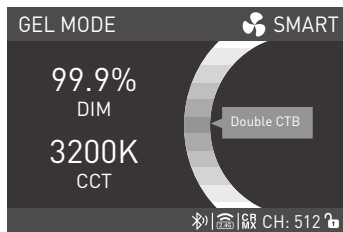

Rotate the "right knob" to select the needed gel.

2.6 Effect Mode

Evoke 900C has built-in effects including: HUE Loop, CCT Loop, INT Loop, Flash, Pulse, Storm, Police Car, TV, Paparazzi, Candle/Fire, Disco, Bad Bulb, Firework, Explosion and Welding.

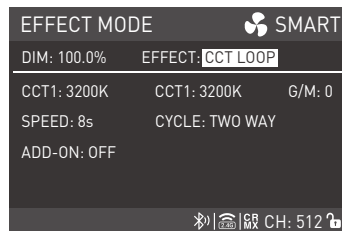
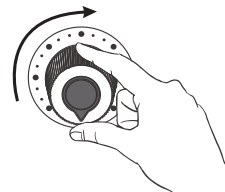
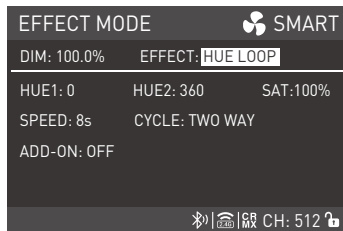

Rotate the "middle knob" to select the effect, which can be adjusted circularly.

① HUE LOOP

HUE LOOP setting, rotate the "right knob" to select HUE 1, HUE 2, SAT, SPEED (range: 2s-30s), CYCLE or ADD-ON, and rotate the "middle knob" to set the parameters.

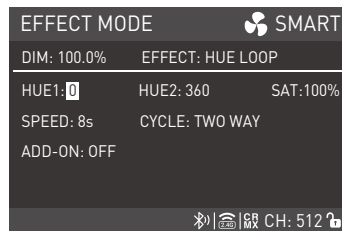
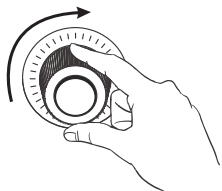
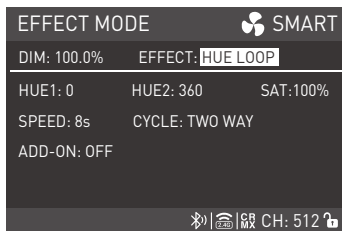

Rotate the "right knob" to select HUE 1, HUE 2, SAT, SPEED (range: 2s-30s), CYCLE or ADD-ON.

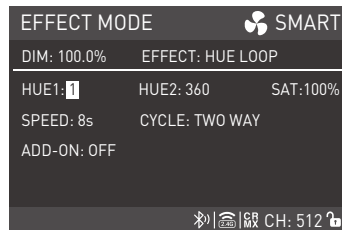
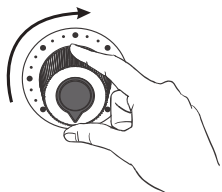
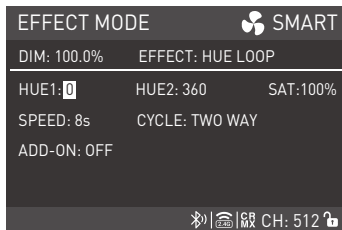

Rotate the "middle knob" to set the parameters.

- There are three cycle modes in HUE LOOP: ONE WAY, TWO WAY and REVERSE, rotate the "middle knob" to select.

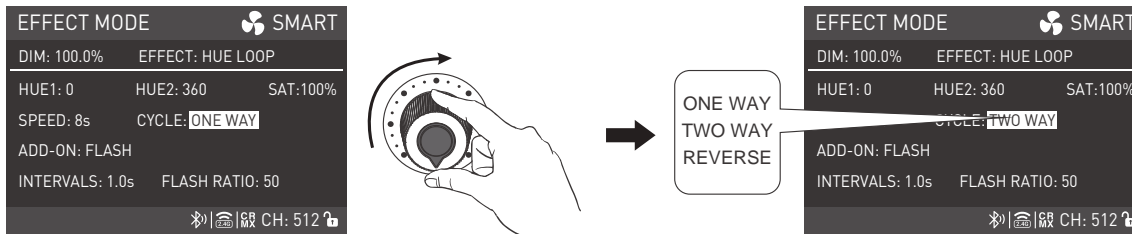

Rotate the "middle knob" to select cycle mode.

- Note: (1) When the cycle mode is in one way or two way, press the "right knob" to cycle from HUE 1.
 (2) When the cycle mode is in reverse, press the "right knob" to cycle from HUE 2.

- There are four add-on effects in HUE loop: OFF, FLASH, RANDOM FLASH and PULSE, rotate the "middle knob" to select.

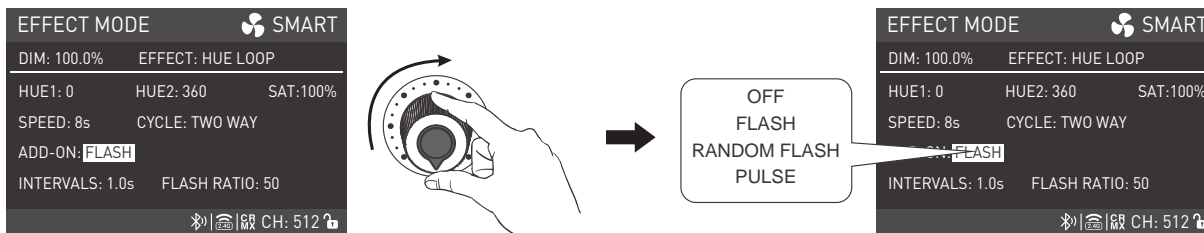

Rotate the "middle knob" to select the add-on effect.

- Note: (1) When the ADD-ON is off, there is no additional effect in the HUE LOOP.
 (2) When the ADD-ON is FLASH, there is flash effect in the HUE loop, flash can be set by adjusting the INTERVALS (range: 0.1s-10s) and FLASH RATIO (0-100).
 (3) When the ADD-ON is RANDOM FLASH, there is flash effect in the HUE loop, flash can be set by adjusting the FLASH SPEED (range: 1-100).
 (4) When the ADD-ON is PULSE, there is pulse effect in the HUE loop, pulse can be set by adjusting the PULSES/MIN (range: 1-240).

@CCT LOOP

CCT LOOP setting, rotate the "right knob" to select CCT 1 , CCT 2, G/M, SPEED (range: 2s-30s), CYCLE or ADD-ON, and rotate the "middle knob" to set the parameters.

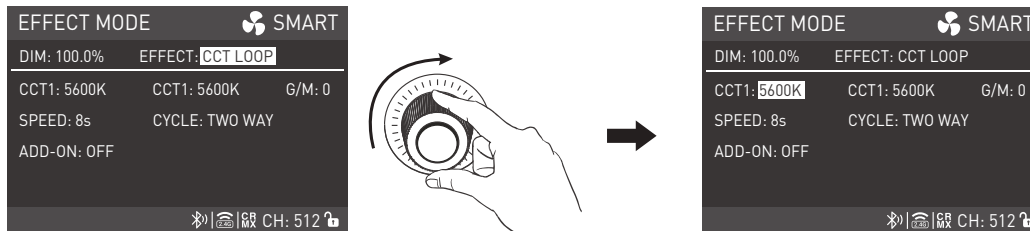

Rotate the "right knob" to select CCT 1 , CCT 2, G/M, SPEED, CYCLE or ADD-ON.

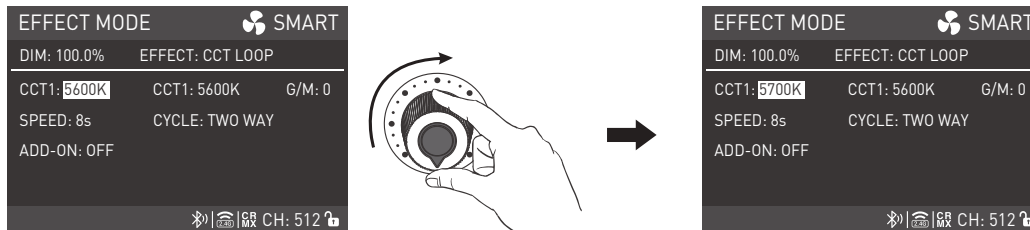

Rotate the "middle knob" to set the parameters.

Note: (1) In CCT LOOP, the setting method and range of CYCLE and ADD-ON are the same as in HUE LOOP.

(2) When the cycle mode is in one way or two way, press the "right knob" to cycle from CCT 1.

(3) When the cycle mode is in reverse, press the "right knob" to cycle from CCT 2.

③ INT LOOP

INT LOOP setting, rotate the "right knob" to select COLOR: CCT or HSI.

- When the color is CCT, rotate the "right knob" to select CCT, G/M, SPEED (range: 2s-30s), CYCLE, DIMMING RANGE or ADD-ON, and rotate the "middle knob" to set the parameters.

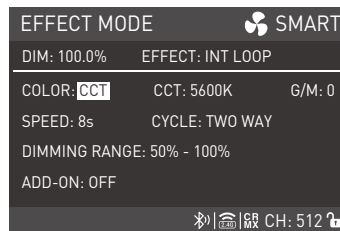
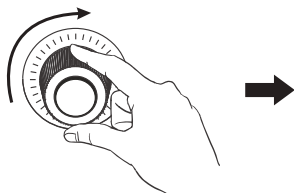
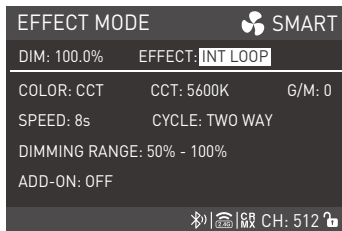

Rotate the "right knob" to select CCT, G/M, SPEED, CYCLE, DIMMING RANGE or ADD-ON.

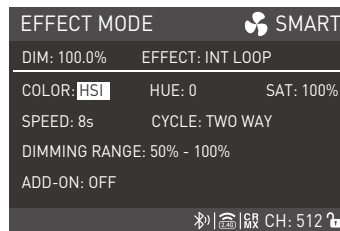
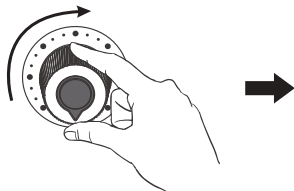
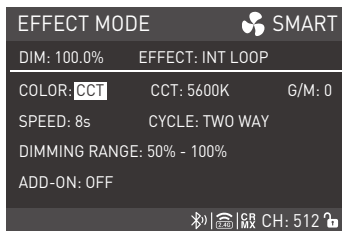

Rotate the "middle knob" to set the parameters.

- When the color is HSI, rotate the "right knob" to select HUE, SAT, SPEED (range: 2s -30s), CYCLE, DIMMING RANGE or ADD-ON, and rotate the "middle knob" to set the parameters.
- There are three cycle modes in INT LOOP: ONE WAY, TWO WAY and REVERSE.
There are four add-on effects in INT loop: OFF, FLASH, RANDOM FLASH and PULSE.

Note: (1) The setting method and range of CYCLE and ADD-ON are the same as in HUE LOOP.

(2) In INT loop, press the "right knob" to restart cycle.

④ FLASH

FLASH setting, rotate the "right knob" to select COLOR: CCT or HSI.

- When the color is CCT, rotate the "right knob" to select CCT, G/M, INTERVALS (range: 0.1s-10s), FLASH RATIO (range: 0-100) or PAUSE, and rotate the "middle knob" to set the parameters.

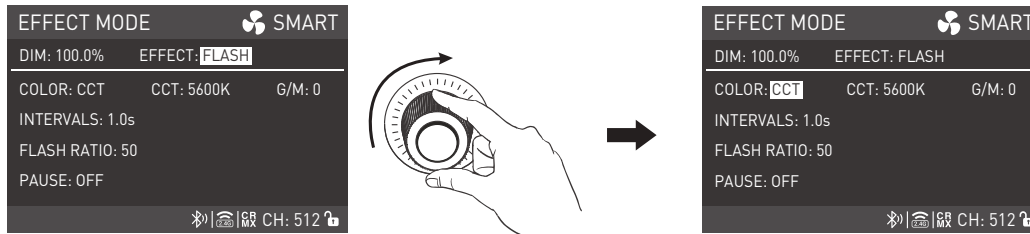

Rotate the "right knob" to select CCT, G/M, INTERVALS, FLASH RATIO or PAUSE.

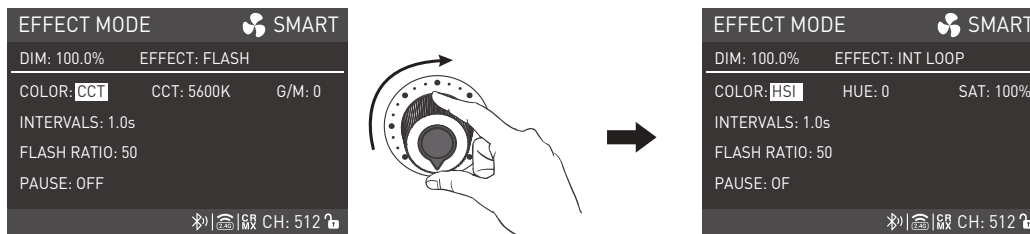

Rotate the "middle knob" to set the parameters.

- When the color is HSI, rotate the "right knob" to select HUE, SAT, INTERVALS, FLASH RATIO or PAUSE, and rotate the "middle knob" to set the parameters (same setting method as in CCT).

Note: Pause includes ON and OFF. When pause is on, the fixture won't flash.

⑤ PULSE

PULSE setting, rotate the "right knob" to select COLOR: CCT or HSI.

- When the color is CCT, rotate the "right knob" to select CCT, G/M or PULSES/MIN (range: 1-240), and rotate the "middle knob" to set the parameters.

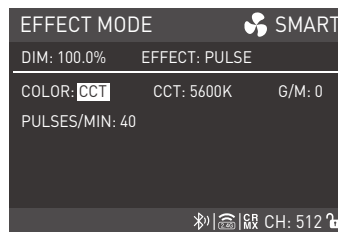
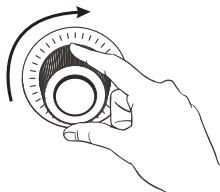
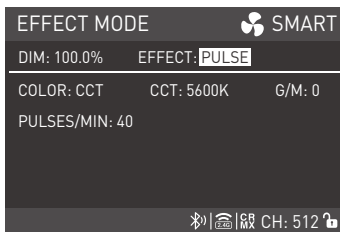

Rotate the "right knob" to select CCT, G/M or PULSES/MIN.

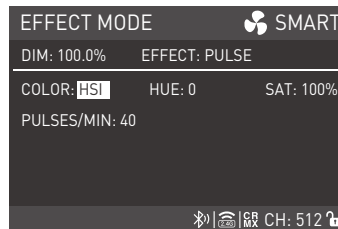
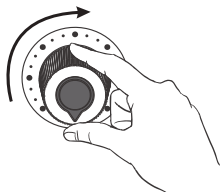
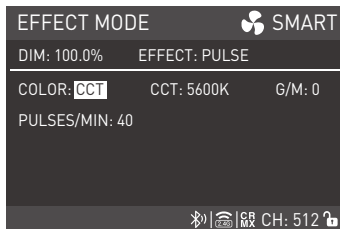

Rotate the "middle knob" to set the parameters.

- When the color is HSI, rotate the "right knob" to select HUE, SAT or PULSES/MIN (range:1-240), and rotate the "middle knob" to set the parameters (same setting method as in CCT).

ⓈSTORM

STORM setting, rotate the "right knob" to select TRIGGER: AUTO or MANUAL.

- When the trigger is AUTO, rotate the "right knob" to select CCT, FLASH TIMES (range: 1-10) , INTERVAL RANGE (range: 1s-60s) or PAUSE, and rotate the "middle knob" to set the parameters.

Note: Pause includes ON and OFF. When the pause is on, the fixture will remain on.

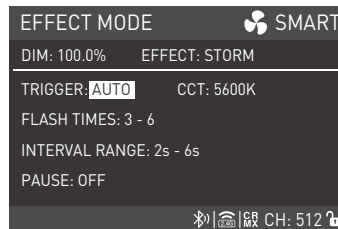
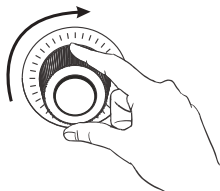
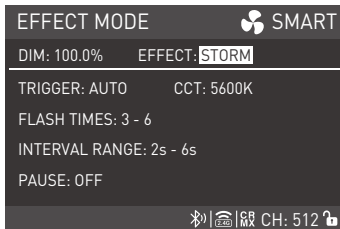

Rotate the "right knob" to select CCT, FLASH TIMES, INTERVAL RANGE or PAUSE.

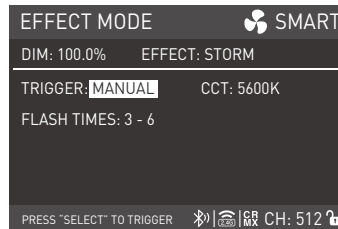
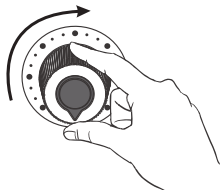
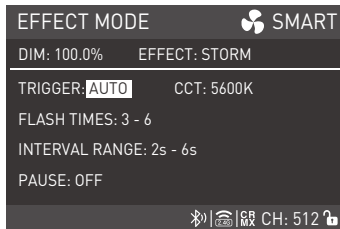

Rotate the "middle knob" to set the parameters.

- When the trigger is MANUAL, rotate the "right knob" to select CCT or FLASH TIMES, and rotate the "middle knob" to set the parameters, press the "right knob" to trigger the storm effect.

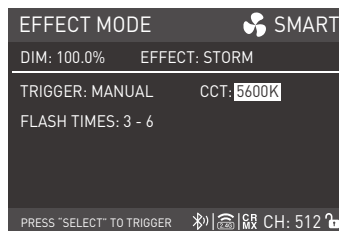
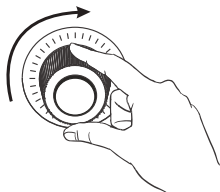
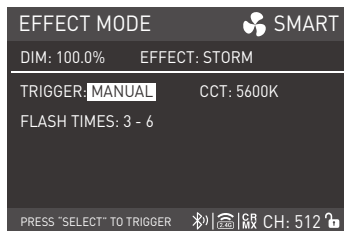

Rotate the "right knob" to select CCT or FLASH TIMES.

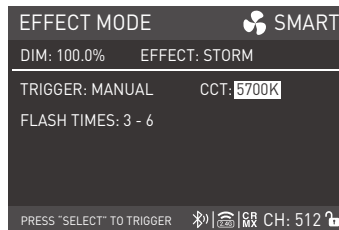
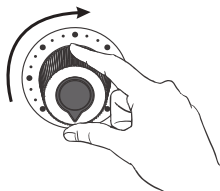
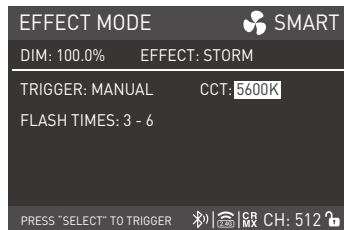

Rotate the "middle knob" to set the parameters.

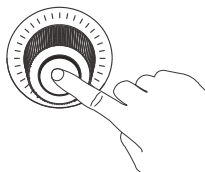
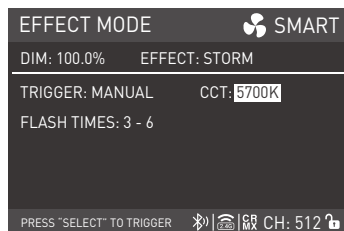

Press the "right knob" to trigger the storm effect.

⑦ POLICE CAR

POLICE CAR setting, rotate the "right knob" to select COLOR, MODE or SPEED (range: 1-100), COLOR includes: BLUE, RED & BLUE, BLUE & WHITE, RED & BLUE & WHITE, MODE includes: SINGLE, DOUBLE, TRIPLE and QUAD.

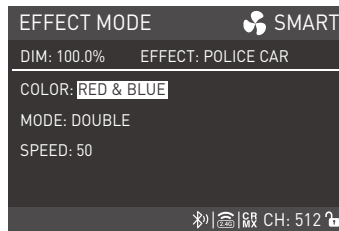
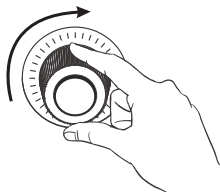
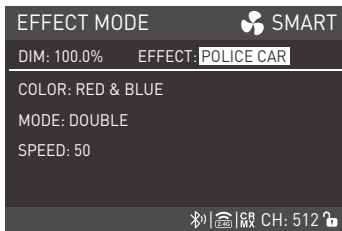

Rotate the "right knob" to select COLOR, MODE or SPEED.

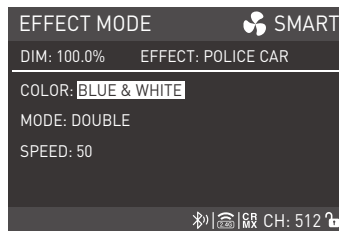
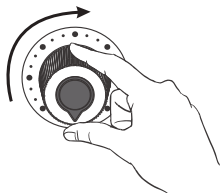
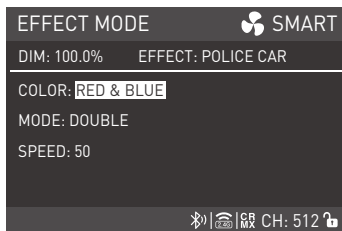

Rotate the "middle knob" to set the parameters.

ⓉTV

TV setting, rotate the "right knob" to select COLOR: CCT or HSI.

- When the color is CCT, rotate the "right knob" to select CCT, G/M, CCT SHIFT (range: 0K-3000K), SPEED (range: 1-100) or DIMMING RANGE, and rotate the "middle knob" to set the parameters.

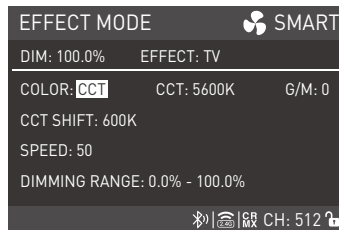
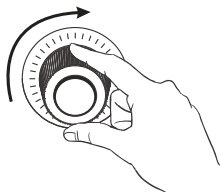
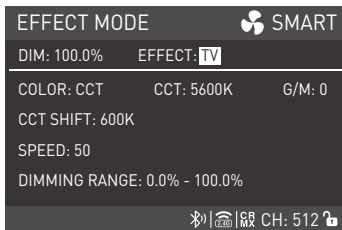

Rotate the "right knob" to select CCT, G/M, CCT SHIFT, SPEED or DIMMING RANGE.

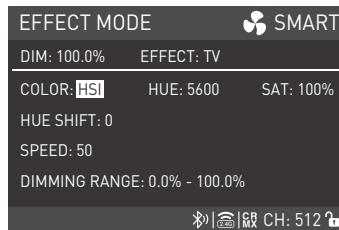
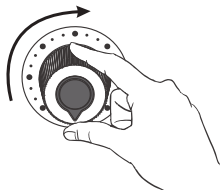
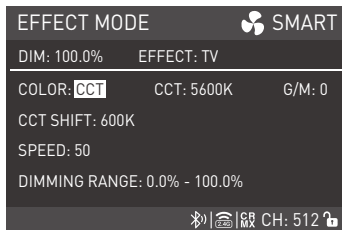

Rotate the "middle knob" to set the parameters.

- When the color is HSI, rotate the "right knob" to select HUE, SAT, HUE SHIFT (range: 0-180), SPEED (range: 1-100), or DIMMING RANGE, and rotate the "middle knob" to set the parameters (same setting method as in CCT).

Ⓞ PAPARAZZI

PAPARAZZI setting, rotate the "right knob" to select CCT, G/M or SPEED (range:1-100), and rotate the "middle knob" to set the parameters.

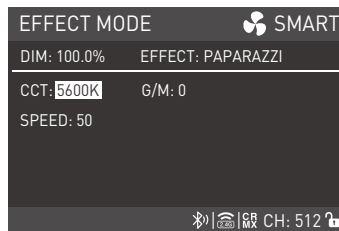
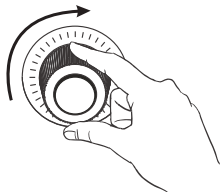
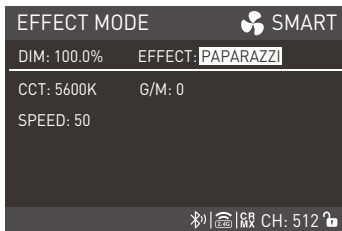

Rotate the "right knob" to select CCT, G/M or SPEED.

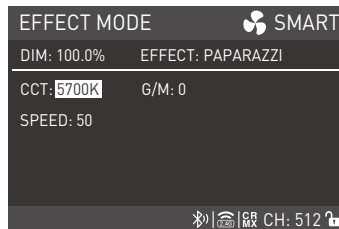
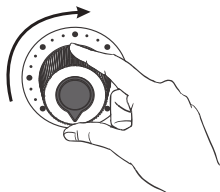
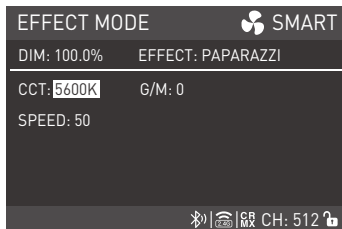

Rotate the "middle knob" to set the parameters.

ⓄCANDLE/FIRE

CANDLE/FIRE setting, rotate the "right knob" to select COLOR: CCT or HSI.

- When the color is CCT, rotate the "right knob" to select CCT, G/M, SPEED (range: 1-100), CCT SHIFT (range: 0K-3000K), DIMMING RANGE or FLICKER, and rotate the "middle knob" to set the parameters.

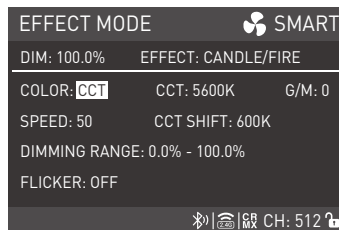
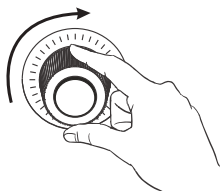
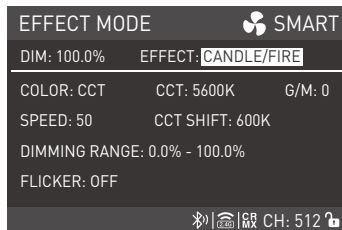

Rotate the "right knob" to select CCT, G/M, SPEED, CCT SHIFT, DIMMING RANGE or FLICKER.

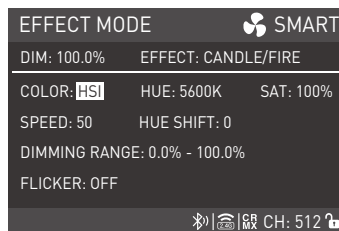
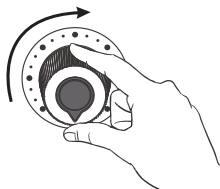
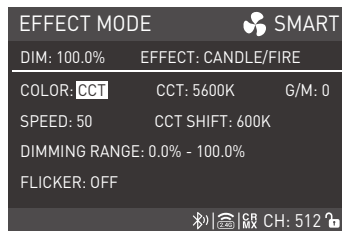

Rotate the "middle knob" to set the parameters.

- When the color is HSI, rotate the "right knob" to select HUE, SAT, SPEED (range: 1-100), HUE SHIFT (range: 0-180), DIMMING RANGE or FLICKER, and rotate the "middle knob" to set the parameters (same setting method as in CCT).

Note: Flicker includes ON and OFF. When the flicker is on, there is flicker in CANDLE/FIRE effect.

④DISCO

DISCO setting, rotate the "right knob" to select COLOR: DEFAULT or MANUAL.

- When the color is DEFAULT, rotate the "right knob" to select AMOUNT (range: 3, 6, 9, 12, 15, 18, 21, 24), SPEED (range: 1-100) or SAT, and rotate the "middle knob" to set the parameters.

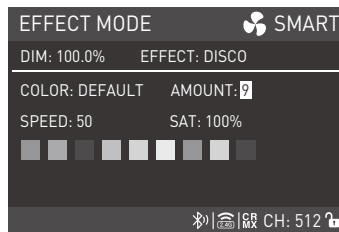
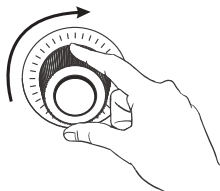
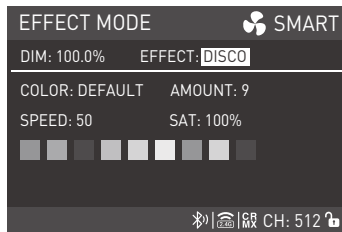

Rotate the "right knob" to select AMOUNT, SPEED or SAT.

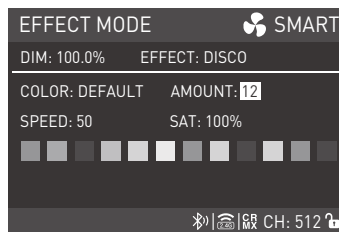
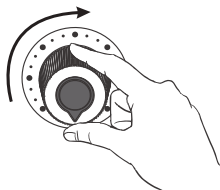
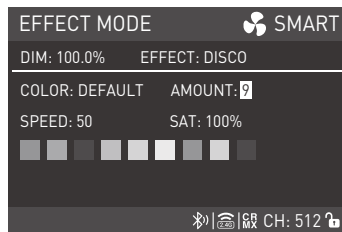

Rotate the "middle knob" to set the parameters.

- When the color is MANUAL, rotate the "right knob" to select AMOUNT (range: 1-6), SPEED (range: 1-100) or SAT. There will be different colors at the bottom of the screen when different amounts are set. For example, when amount is 1, C1 will display at the bottom of the screen, when amount is 2, C1, C2 will display, and so on. C1-C6 range: 0-360, and rotate the "middle knob" to set the parameters.

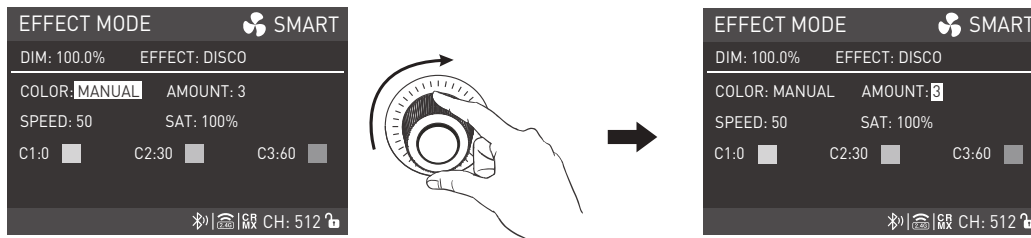

Rotate the "right knob" to select AMOUNT, SPEED or SAT.

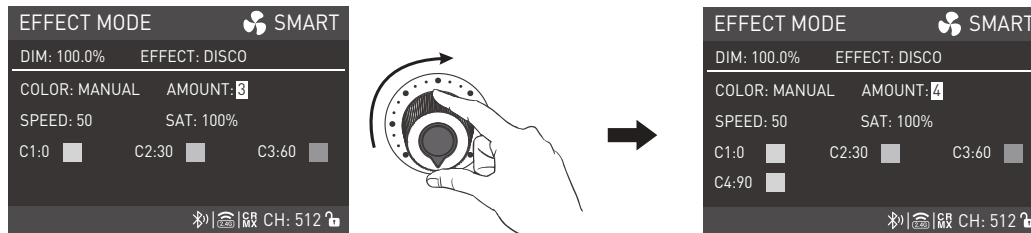

Rotate the "middle knob" to set the parameters.

@BAD BULB

BAD BULB setting, rotate the "right knob" to select COLOR: CCT or HSI.

- When the color is CCT, rotate the "right knob" to select CCT, G/M, INTENSITY (range: 1-100) or SPEED (range: 1-100), and rotate the "middle knob" to set the parameters.

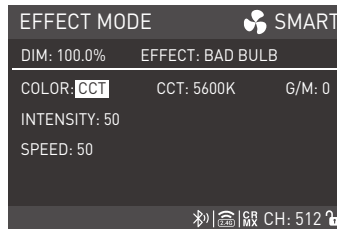
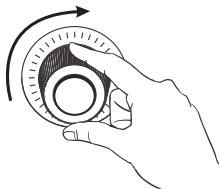
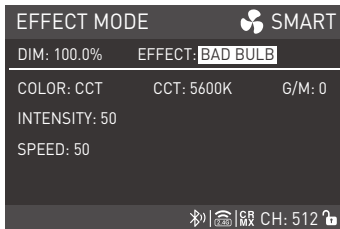

Rotate the "right knob" to select CCT, G/M, INTENSITY or SPEED.

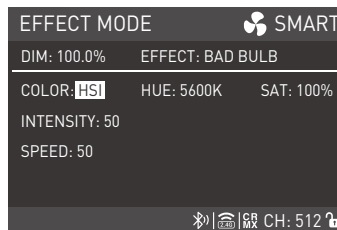
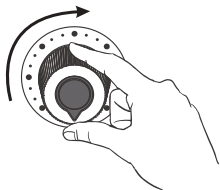
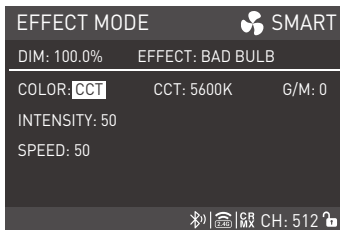

Rotate the "middle knob" to set the parameters.

- When the color is HSI, rotate the "right knob" to select HUE, SAT, INTENSITY (range: 1-100) or SPEED (range: 1-100), and rotate the "middle knob" to set the parameters (same setting method as in CCT).

③ FIREWORK

FIREWORK setting, rotate the "right knob" to select COLOR: MANUAL, DEFAULT or CCT.

- When the color is MANUAL, rotate the "right knob" to select AMOUNT (range: 1-6), SPEED (range: 1-100), DECAY (range: 1-100) or SAT. There will be different colors at the bottom of the screen when different amounts are set. For example, when amount is 1, C1 will display at the bottom of the screen, when amount is 2, C1, C2 will display, and so on. C1-C6 range: 0-360, and rotate the "middle knob" to set the parameters.

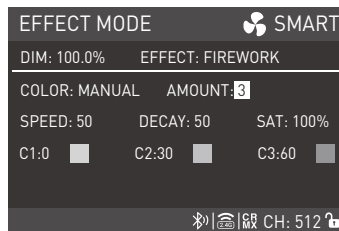
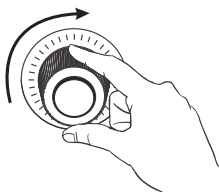
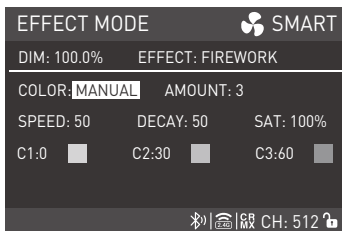

Rotate the "right knob" to select AMOUNT, SPEED, DECAY or SAT.

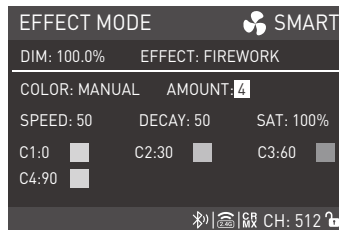
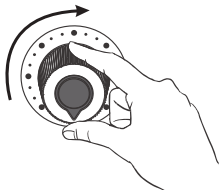
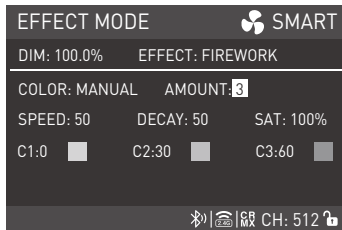

Rotate the "middle knob" to set the parameters.

- When the color is DEFAULT, rotate the "right knob" to select AMOUNT (range: 3, 6, 9, 12, 15, 18, 21, 24), SPEED (range: 1-100), DECAY (range: 1-100) or SAT, and rotate the "middle knob" to set the parameters.

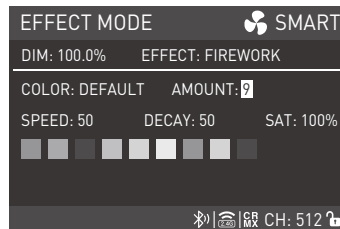
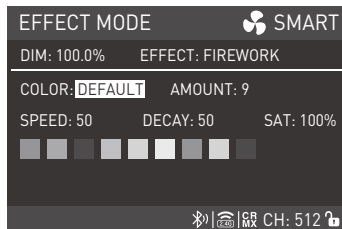

Rotate the "right knob" to select AMOUNT, SPEED, DECAY or SAT.

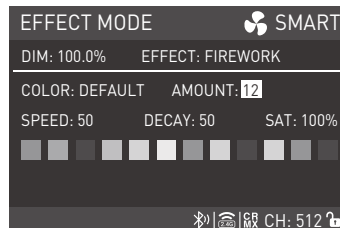
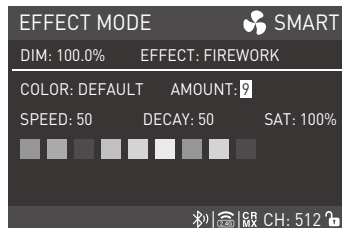

Rotate the "middle knob" to set the parameters.

- When the color is CCT, rotate the "right knob" to select CCT, G/M, CCT SHIFT (range:0K-3000K), SPEED (range: 1-100) or DECAY (range: 1-100), and rotate the "middle knob" to set the parameters.

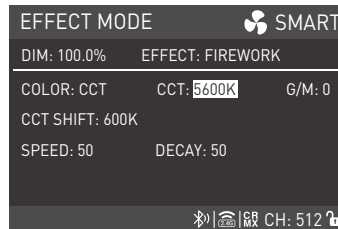
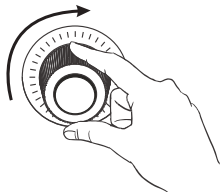
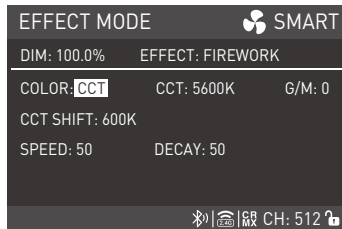

Rotate the "right knob" to select CCT, G/M, CCT SHIFT, SPEED or DECAY.

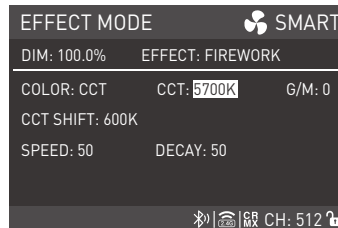
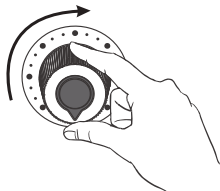
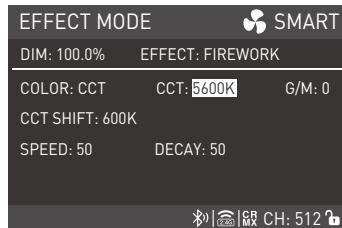

Rotate the "middle knob" to set the parameters.

⑭ EXPLOSION

EXPLOSION setting, rotate the "right knob" to select TRIGGER (include: AUTO and MANUAL) or COLOR (include: CCT and HSI).

- When the trigger is AUTO and color is CCT, rotate the "right knob" to select CCT, G/M, SPEED (range: 1-100) or DECAY (range: 1-100), and rotate the "middle knob" to set the parameters.

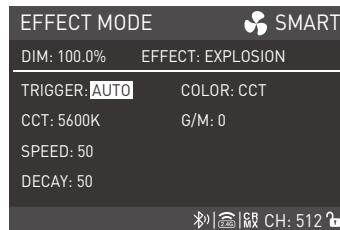
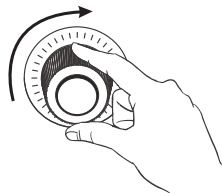
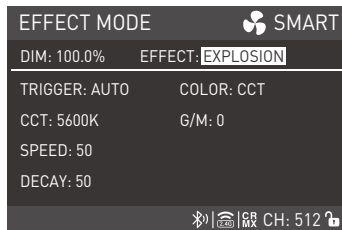

Rotate the "right knob" to select CCT, G/M, SPEED or DECAY.

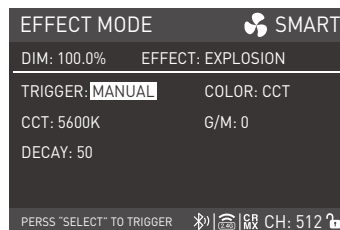
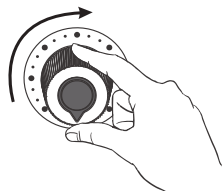
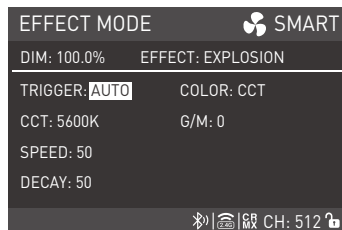

Rotate the "middle knob" to set the parameters.

- When the trigger is AUTO and color is HSI, rotate the "right knob" to select HUE, SAT, SPEED (range: 1-100) or DECAY (range: 1-100), and rotate the "middle knob" to set the parameters (same setting method as in CCT).

- When the trigger is MANUAL and color is CCT, rotate the "right knob" to select CCT, G/M or DECAy (range: 1-100), and rotate the "middle knob" to set the parameters. Press the "right knob" to trigger explosion effect.

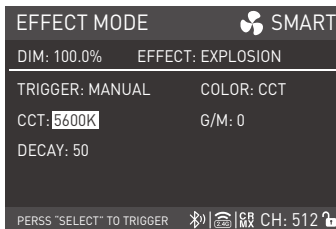
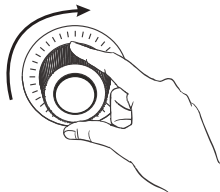
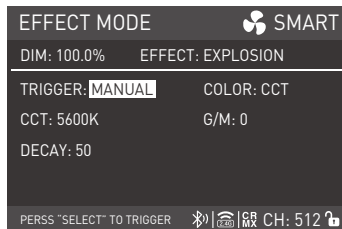

Rotate the "right knob" to select CCT, G/M or DECAy.

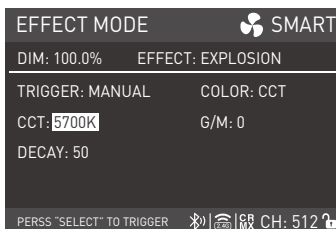
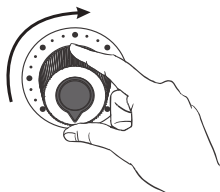
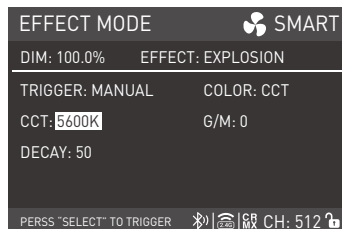

Rotate the "middle knob" to set the parameters.

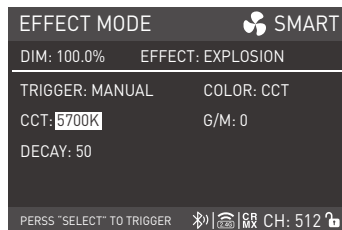

Press the "right knob" to trigger explosion effect.

- When the trigger is MANUAL and color is HSI, rotate the "right knob" to select HUE, SAT or DECAy (range: 1-100), and rotate the "middle knob" to set the parameters. Press the "right knob" to trigger explosion effect (same setting method as in CCT).

⑤ WELDING

WELDING settings, rotate the "right knob" to select COLOR: CCT or HSI.

- When the color is CCT, rotate the "right knob" to select CCT, G/M, SPEED (range: 1-100), DIMMING RANGE or PAUSE, and rotate the "middle knob" to set the parameters.

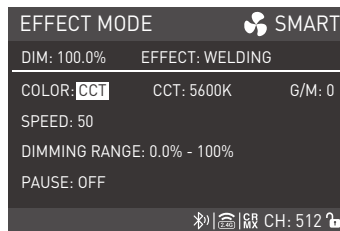
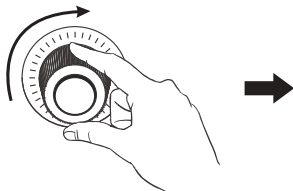
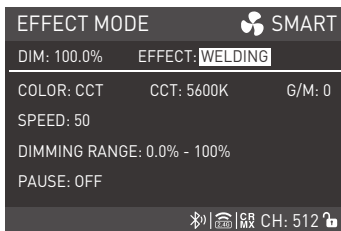

Rotate the "right knob" to select CCT, G/M, SPEED, DIMMING RANGE or PAUSE.

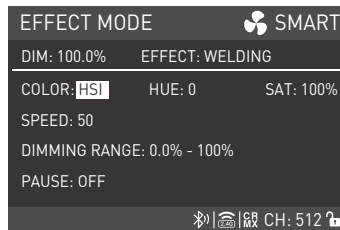
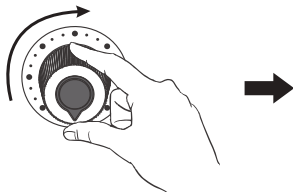
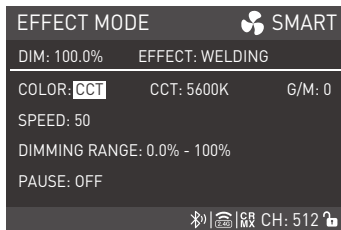

Rotate the "middle knob" to set the parameters.

- When the color is HSI, rotate the "right knob" to select HUE, SAT, SPEED (range: 1-100), DIMMING RANGE or PAUSE, and rotate the "middle knob" to set the parameters (same setting method as in CCT).

Note: Pause includes ON and OFF. When the pause is on, the welding effect will suspend.

- Lighting effects and additional functionality will be probably upgraded with later firmware version. Detailed information is subject to the latest firmware instruction.

3. MENU Button: Press MENU button to enter the interface.

Rotate the "right knob" to select the needed option, and press the "right knob" to enter the secondary menu. Rotate the "right knob" to select the needed option, and press the "right knob" to set, press the MENU button to return to the previous menu.

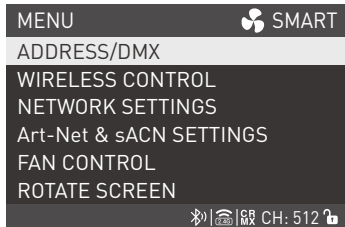

left knob



middle knob



right knob

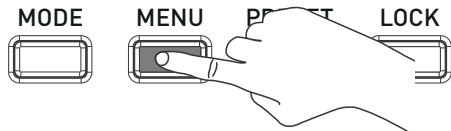

3.1 ADDRESS/DMX

For more operation details please refer to P16.

3.2 WIRELESS CONTROL

For more operation details please refer to P22.

3.3 NETWORK SETTINGS

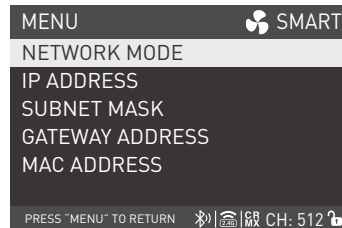
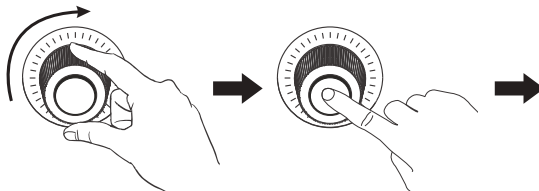
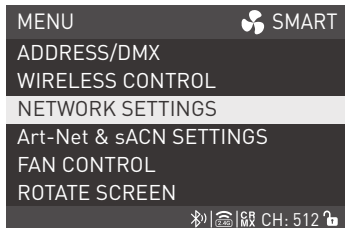

Rotate the "right knob" to NETWORK SETTINGS, and press the "right knob" to enter the secondary menu.

① NETWORK MODE

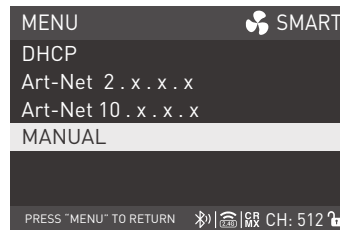
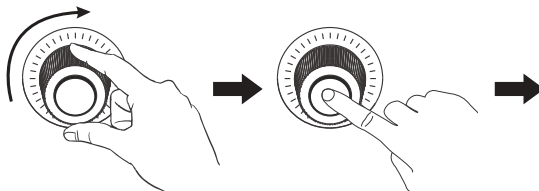
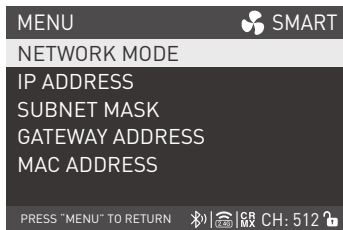

Rotate the "right knob" to NETWORK MODE, and press the "right knob" to enter the tertiary menu.

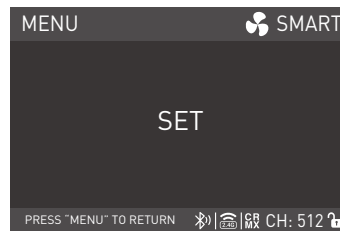
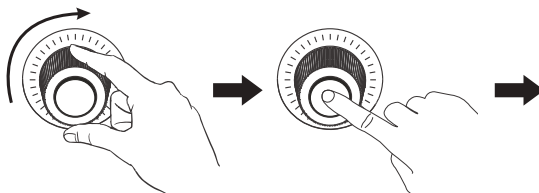
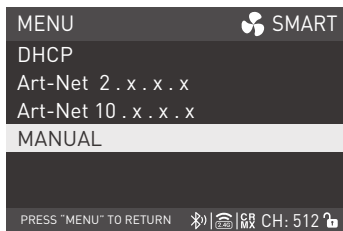

Rotate the "right knob" to select the needed network mode, and press the "right knob" to set.

Note: When DHCP or Art-Net is selected, the IP ADDRESS, SUBNET MASK and GATEWAY ADDRESS will be set automatically. When MANUAL is selected, the IP ADDRESS, SUBNET MASK and GATEWAY ADDRESS can be set manually.

② IP ADDRESS

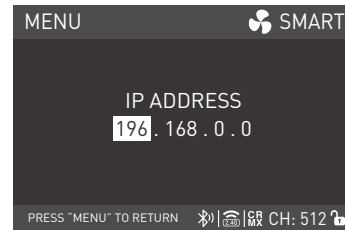
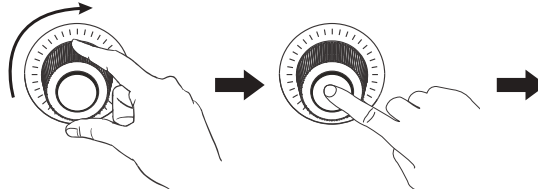
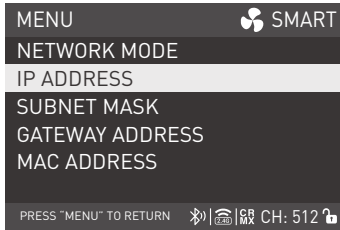

Rotate the "right knob" to IP ADDRESS, and press the "right knob" to enter the tertiary menu.

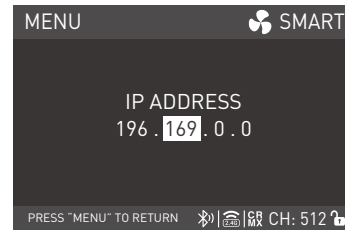
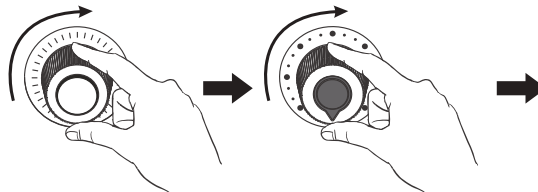
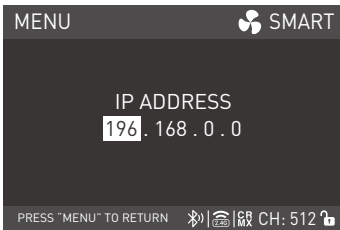

Rotate the "right knob" to the bytes, and rotate the "middle knob" to select the needed IP address.

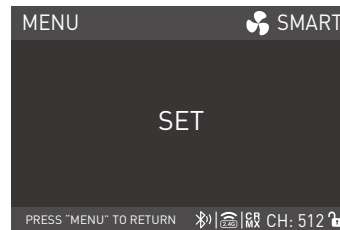
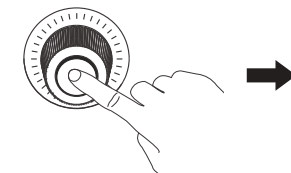
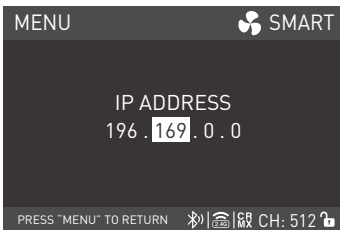

Press the "right knob" to set.

③ SUBNET MASK

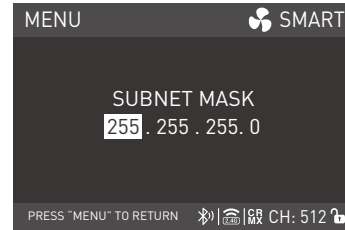
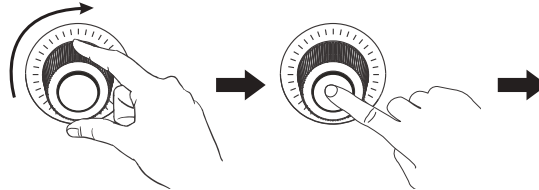

Rotate the "right knob" to SUBNET MASK, and press the "right knob" to enter the tertiary menu.

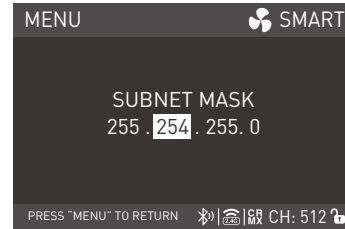
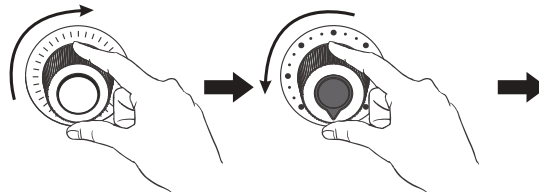

Rotate the "right knob" to the subnet, and rotate the "middle knob" to select the needed subnet mask.

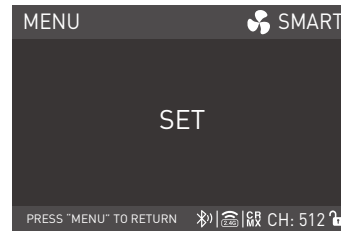
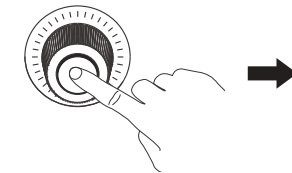

Press the "right knob" to set.

④ GATEWAY ADDRESS

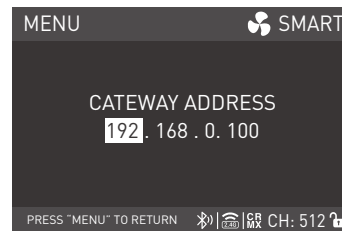
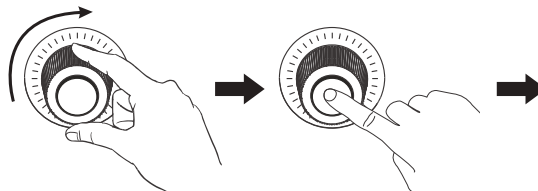
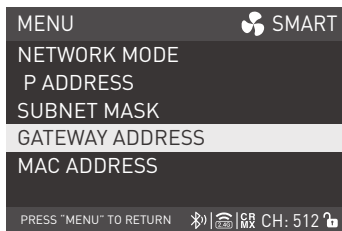

Rotate the "right knob" to GATEWAY ADDRESS, and press the "right knob" to enter the tertiary menu.

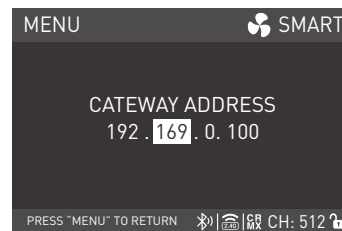
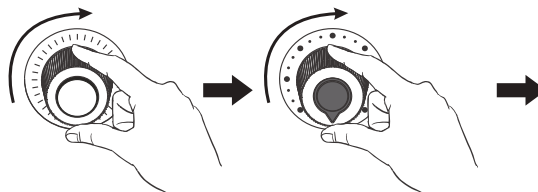
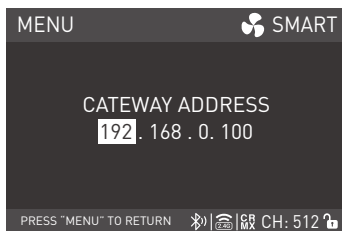

Rotate the "right knob" to the bytes, and rotate the "middle knob" to select the needed gateway address.

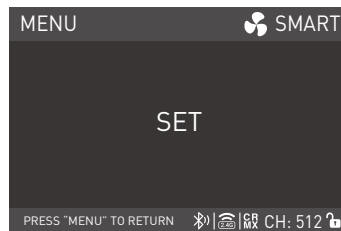
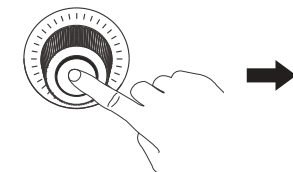
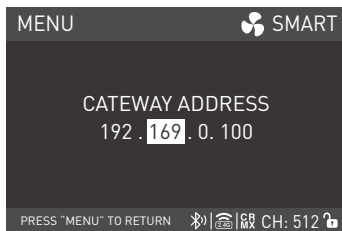

Press the "right knob" to set.

⑤ MAC ADDRESS

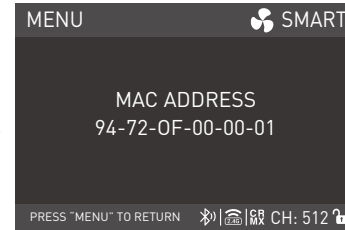
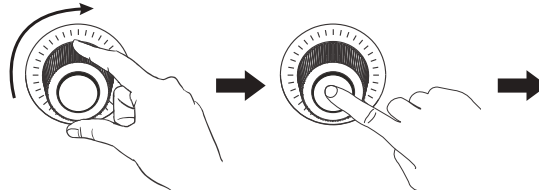
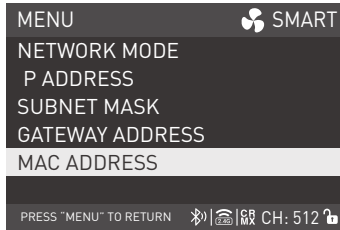

Rotate the "right knob" to MAC ADDRESS, and press the "right knob" to check.

3.4 Art-Net & sACN

For more operation details please refer to P33.

3.5 FAN CONTROL

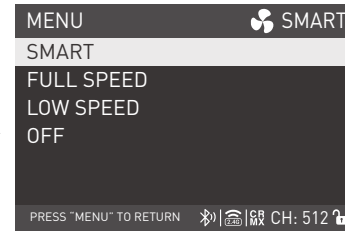
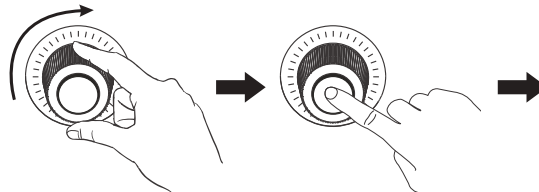
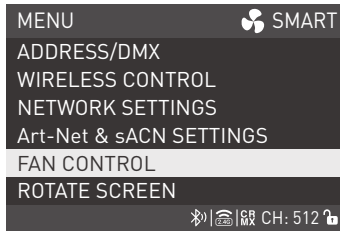

Rotate the "right knob" to FAN CONTROL, and press the "right knob" to enter the secondary menu.

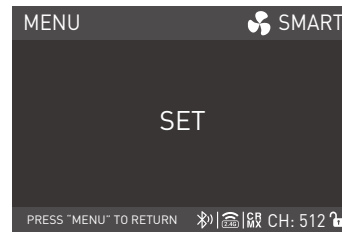
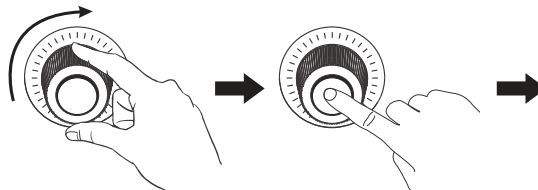
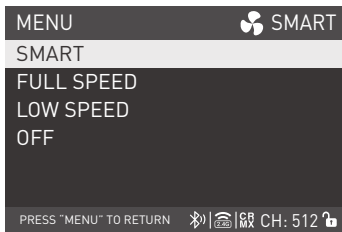

Rotate the "right knob" to select speed: SMART, FULL SPEED, LOW SPEED or OFF, and press the "right knob" to set.

Note: When the fan is off, the built-in fan will stop working, and the maximum output of fixture is 20%. When the fan is in low speed, the maximum output is 70%. When the fan is in smart or full speed state, the maximum output is 100%.

3.6 ROTATE SCREEN

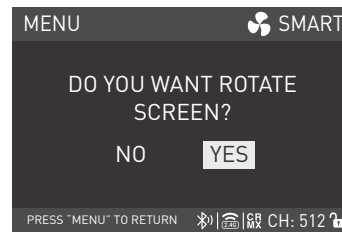
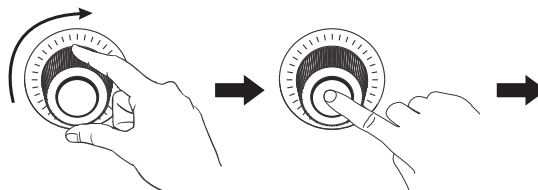
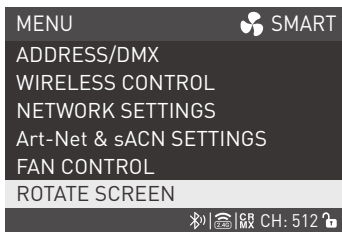

Rotate the "right knob" to the ROTATE SCREEN, and press the "right knob" to enter the secondary menu.

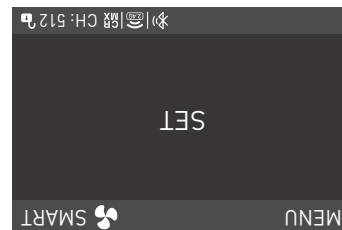
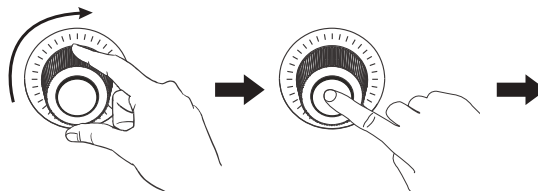
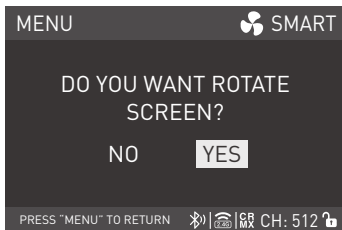

Rotate the "right knob" to select YES or NO, and press the "right knob" to set.

3.7 SCREEN BRIGHTNESS

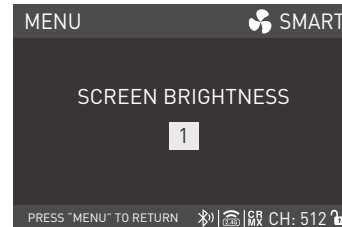
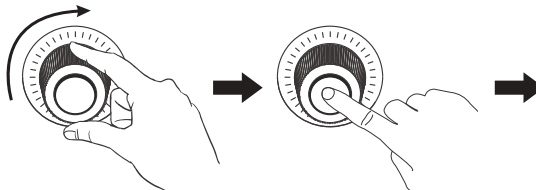
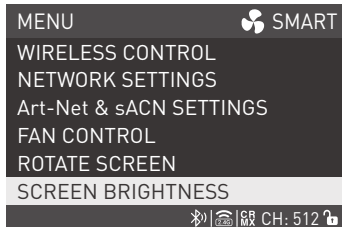

Rotate the "right knob" to SCREEN BRIGHTNESS, and press the "right knob" to enter the secondary menu.

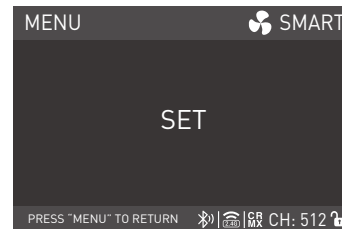
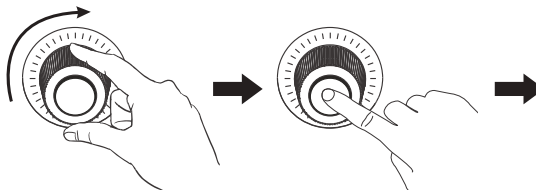
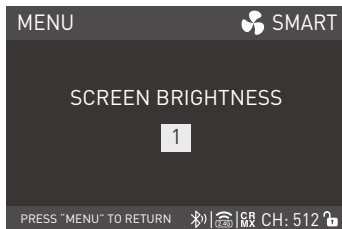

Rotate the "right knob" to select the screen brightness, and press the "right knob" to set.

3.8 BUTTON BACKLIGHT

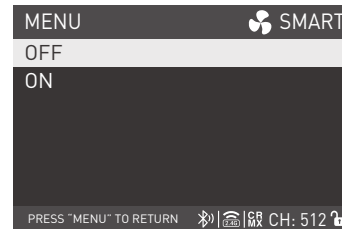
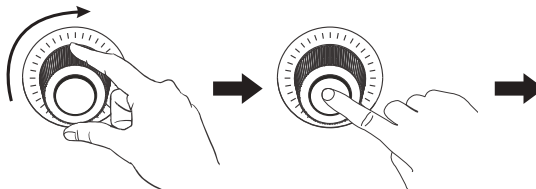
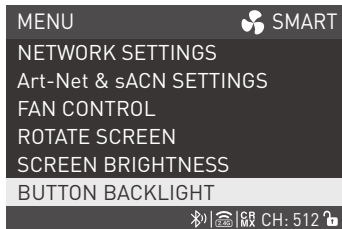

Rotate the "right knob" to BUTTON BACKLIGHT, and press the "right knob" to enter the secondary menu.

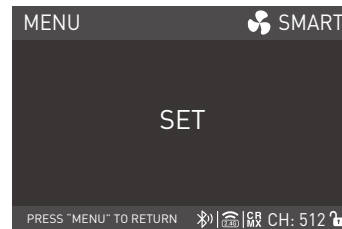
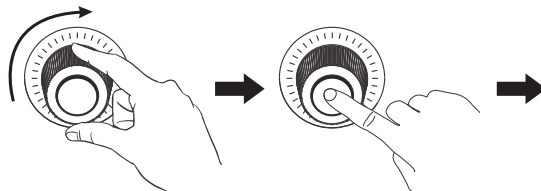

Rotate the "right knob" to select ON or OFF, and press the "right knob" to set.

3.9 LANGUAGE

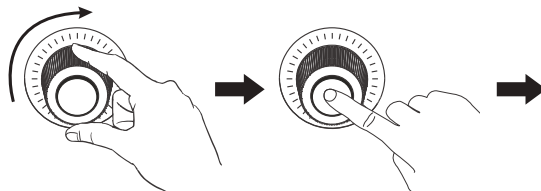

Rotate the "right knob" to LANGUAGE, and press the "right knob" to enter the secondary menu.

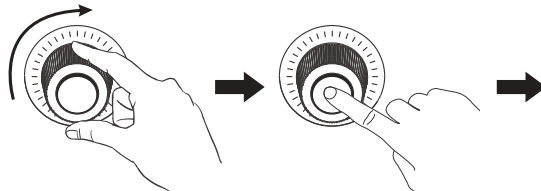

Rotate the "right knob" to select ENGLISH or 简体中文, and press the "right knob" to set.

3.10 FIRMWARE UPDATE

Put the two firmware files of Evoke 900C into the root directory of the USB drive (ensure the firmware versions match), and connect the USB drive to the USB port.

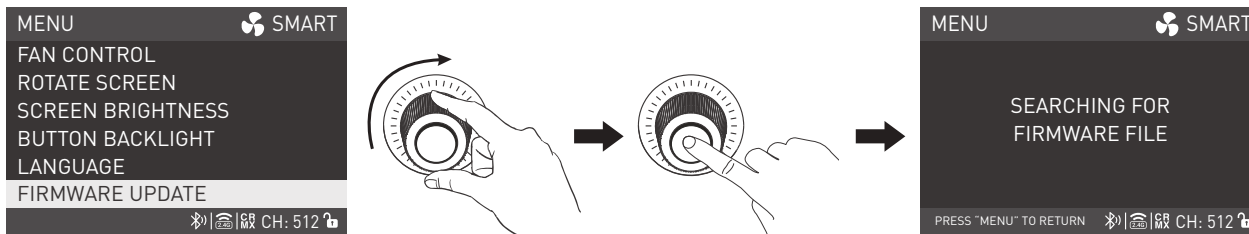

Rotate the "right knob" to FIRMWARE UPDATE, and press the "right knob" to enter the interface to search for the firmware files.

Note:

1. Please do not rename the firmware files.
2. Ensure the USB drive is formatted to FAT, FAT32 or exFAT.
3. If prompted that "THE VERSIONS OF THE TWO FIRMWARE FILES DON'T MATCH, PLEASE CHECK THE FILES AND TRY AGAIN", please check whether the versions of the two firmware files are consistent.
4. If prompted that "MISSING PARTS OF FIRMWARE FILES, PLEASE CHECK THE FILES AND TRY AGAIN", please check whether there are two firmware files in the USB drive.
5. If prompted that "NO FIRMWARE FOUND", please check whether the firmware files are correct, whether the firmware files are put in the root directory of the USB drive, or whether the USB drive format is FAT, FAT32 or exFAT.
6. If all the above steps are done and the firmware files still cannot be found, please format the USB drive again.
7. If the fixture still cannot identify the USB drive, please replace the USB drive.

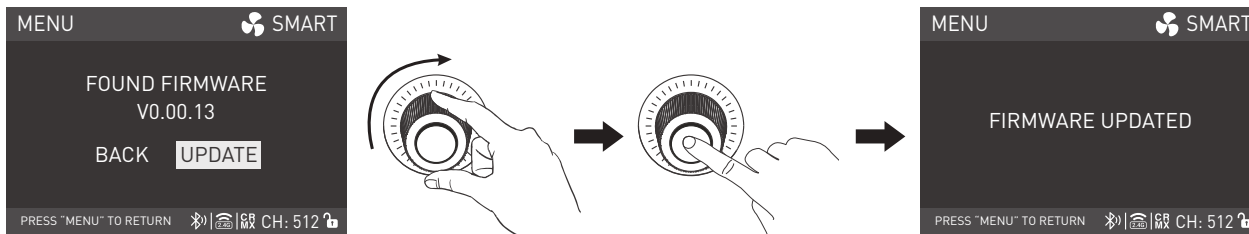

After the firmware file is found, enter the firmware update interface, rotate the "right knob" to select UPDATE, and press the "right knob" to make update. After update, the light fixture will automatically restart.

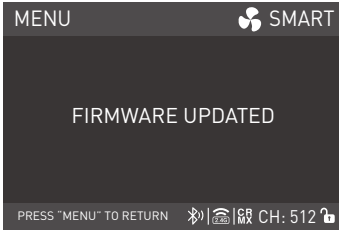

3.11 RESET ALL SETTINGS

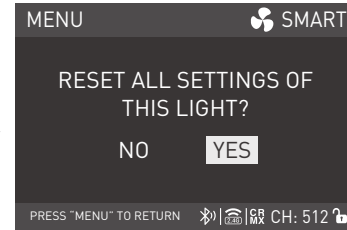
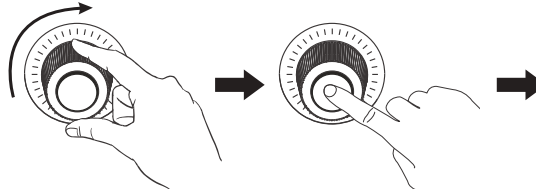
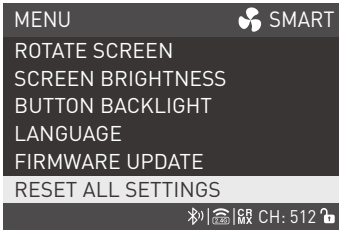

Rotate the "right knob" to RESET ALL SETTINGS, and press the "right knob" to enter the secondary menu.

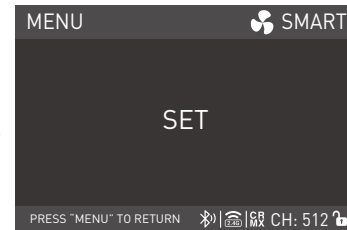
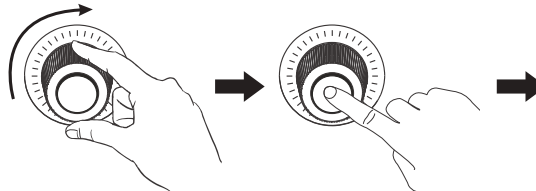
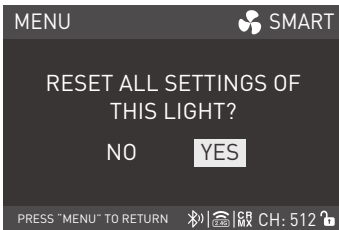

Rotate the "right knob" to select YES or NO, and press the "right knob" to set.

3.12 VERSION

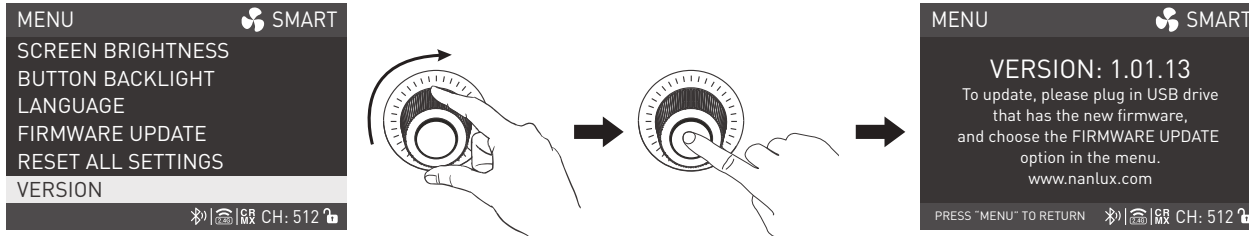

Rotate the "right knob" to VERSION, and press the "right knob" to check the current version.

4. PRESET

Press the PRESET button to enter the interface.

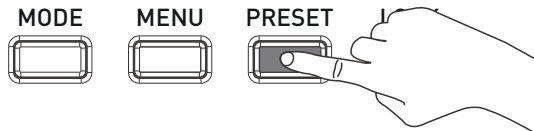
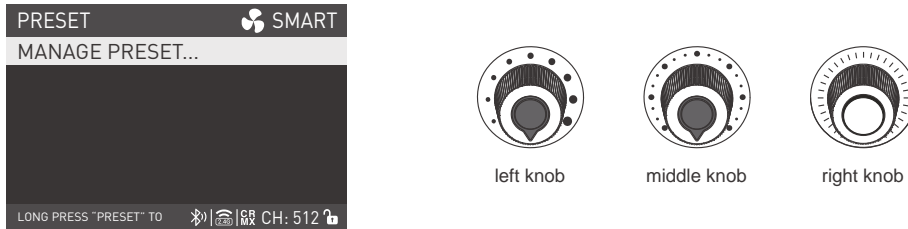

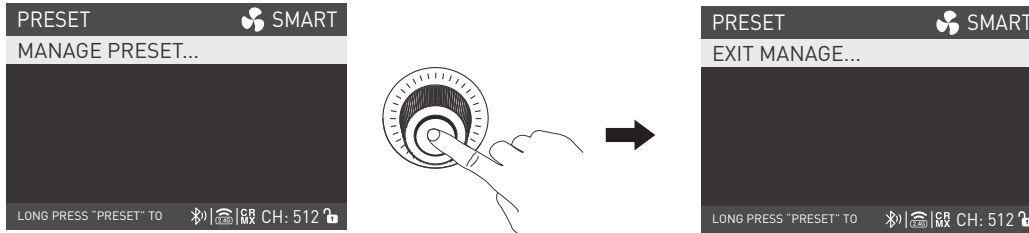

Press the "right knob" to MANAGE PRESET or EXIT MANAGE.

4.1 Save the Settings

Long press the PRESET button to enter the preset interface, to name the settings and save.

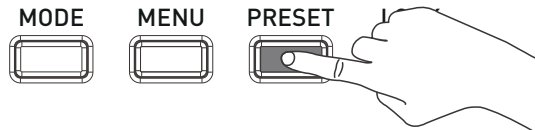
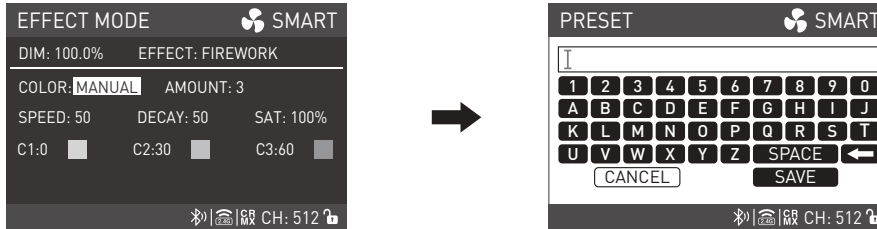

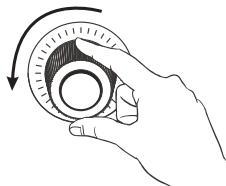
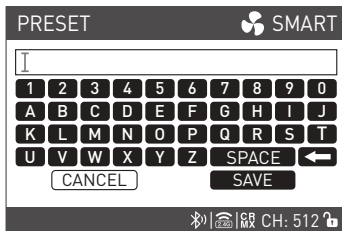

Rotate the "right knob" to select the needed numbers and letters.

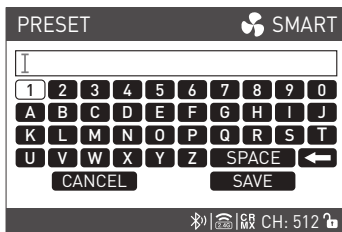

Press the "right knob" to set.

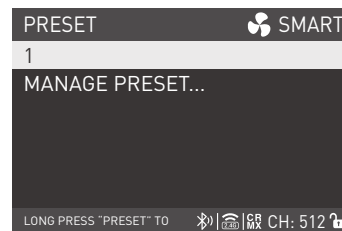
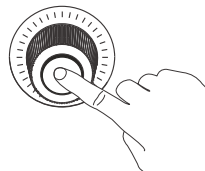
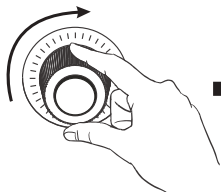

Rotate the "right knob" to SAVE, and press the "right knob" to confirm.

4.2 Trigger the Settings

Press the PRESET button to enter the interface. Rotate the "right knob" to select preset settings, press the "right knob" to trigger the settings. The screen will display the saved settings.

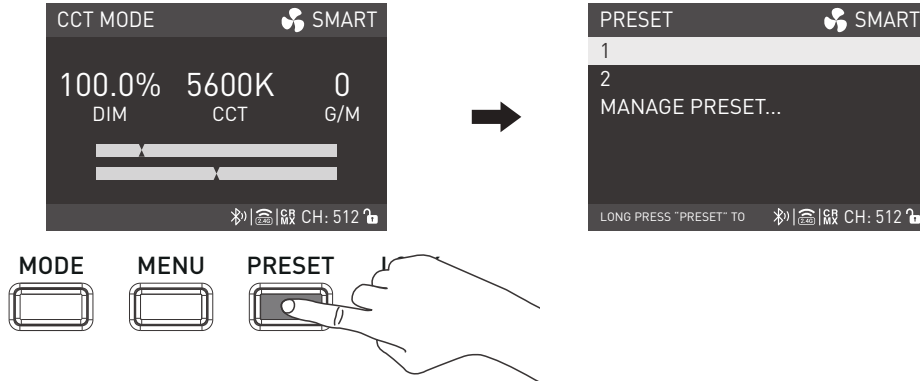

Press the PRESET button to enter the interface.

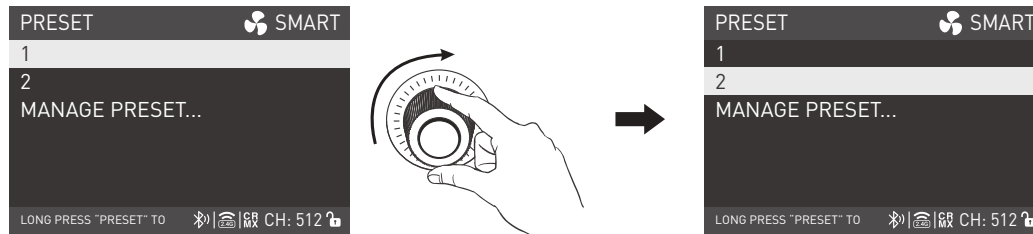

Rotate the "right knob" to select preset settings.

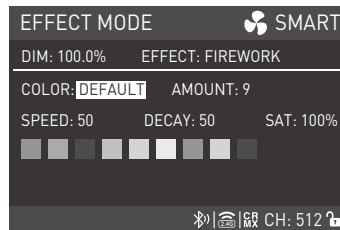
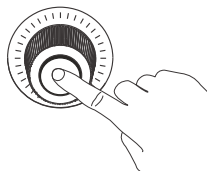

Press the "right knob" to trigger the settings. The screen will display the saved settings.

4.3 Rename or Delete the Preset Settings

Press the PRESET button to enter the interface. Rotate the "right knob" to MANAGE PRESET. Press the "right knob" to EXIT MANAGE, and rotate the "right knob" to select rename or delete the saved preset setting.

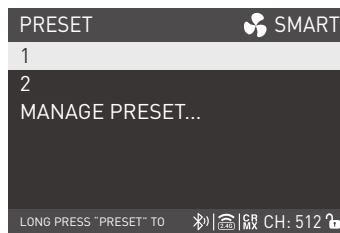
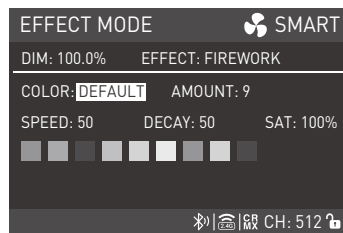

Press the PRESET button to enter the interface.

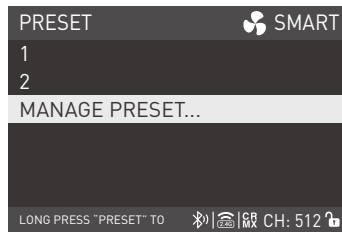
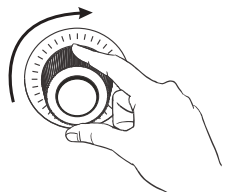
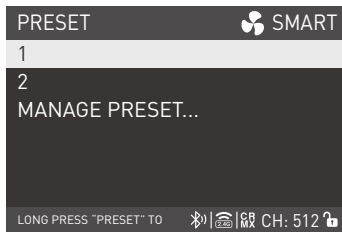

Rotate the "right knob" to MANAGE PRESET.

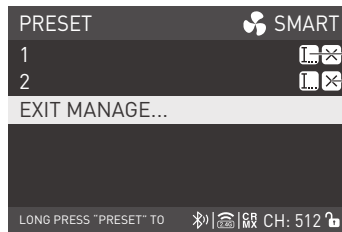
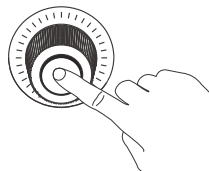

EDIT
DELETE

Press the "right knob" to EXIT MANAGE.

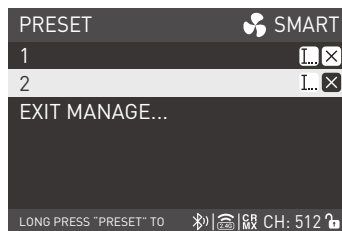
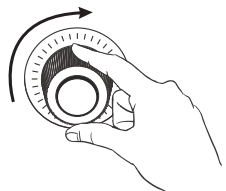
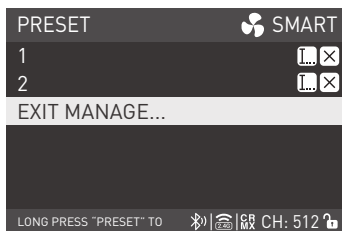

Rotate the "right knob" to select rename or delete the saved preset setting.

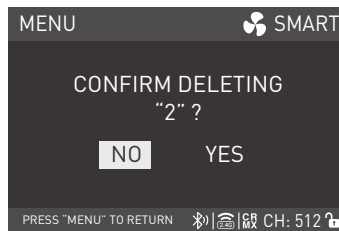
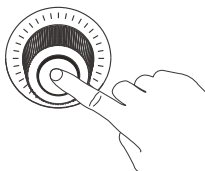
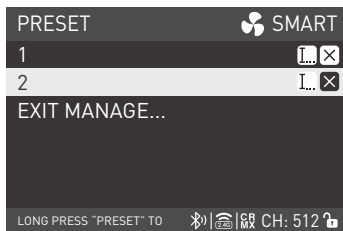

Press the "right knob" to select "x".

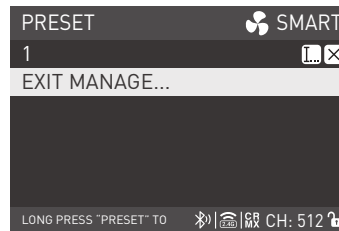
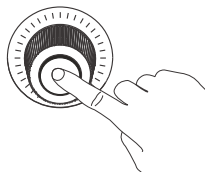
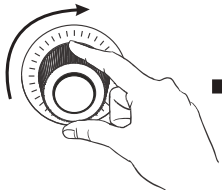
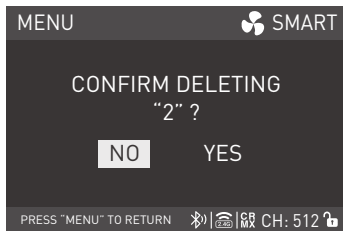

Rotate the "right knob" to YES, and press the "right knob" to delete.

5. LOCK

Long press the LOCK button to lock the settings, at this moment, any operation or adjustment on the button and knob will not change the current setting. Long press the LOCK button again to unlock.

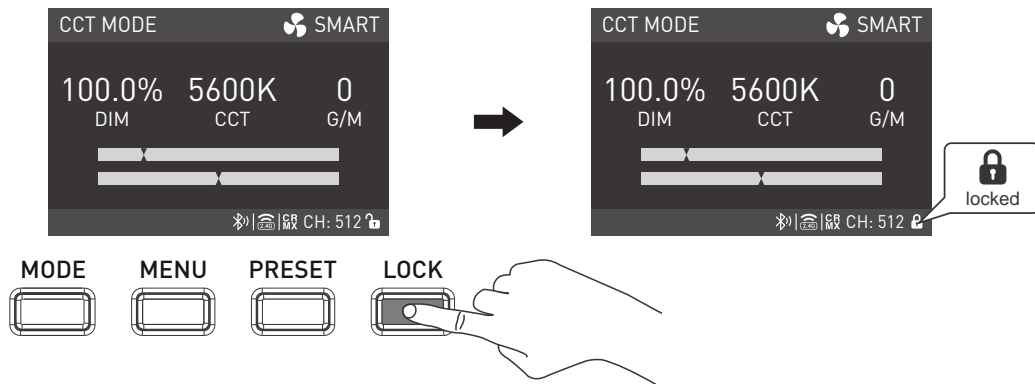

6. When the fixture is not in use, please turn off the power switch.

General Fault Detection and Diagnosis

Fault Detection	Diagnosis
The light won't boot up properly	<ol style="list-style-type: none"> 1. Please check whether the connection between power supply and cable or fixture are loose. 2. Please check whether the voltage value is within the specified parameters.
The fixture can be operated manually, but DMX control is not working.	<ol style="list-style-type: none"> 1. Please check whether the DMX address setting of the fixture is correct. 2. Please check whether the DMX signal cable is connected correctly and without damage.
LCD display is on, but light cannot be operated.	Please check if the screen shows "🔒". Long press the LOCK button for 3s to unlock.
The fan doesn't work	<ol style="list-style-type: none"> 1. Please check if the fan is OFF 2. If the screen displays "Fan abnormal", please contact with the supplier or manufacturer for replacement.
The signal reception distance of 2.4G and Bluetooth is less than 5 meters.	Check whether the LUMENRADIO is in TRANSMITTER MODE, if it is, please disconnect the LUMENRADIO and set it in RECEIVER MODE.

Optional Purchase:

FL-35YK Fresnel Lens	SB-NLM-120-PR Parabolic Softbox
SB-NLM-100-S Square Softbox	RF-NLM-26 Reflector
SB-NLM-150-O Octagonal Softbox	RF-NLM-60 Reflector
LT-NLM-120 Lantern Softbox	RF-NLM-26/60-KIT 26°& 60°Reflector Kit
SB-NLM-150-PR Parabolic Softbox	AS-PJA-NLM NL Mount Projection Adapter

Please scan the QR code for more details.



DMX Reference Guide



Detailed User Manual



Nanlux Website



Nanlink App

This manual has been compiled according to the rigorous testing for Nanlux products. Product designs are subject to change without prior notice. The latest version of the manual for this product is downloadable at www.nanlux.com.

Certification



Made in China

WWW.NANLUX.COM

NANLUX

📞 0754-85751187

✉ info@nanlux.com

☎ 0754-85300887

📍 Dongli Section, Highway 324, Chenghai, Shantou City, Guangdong Province, China