

**NANLITE**

*Forza 500 II*  
USER MANUAL

Guangdong NanGuang Photo&Video Systems Co., Ltd.

# Forza 500 II LED Spot Light

## ■ Product Diagram

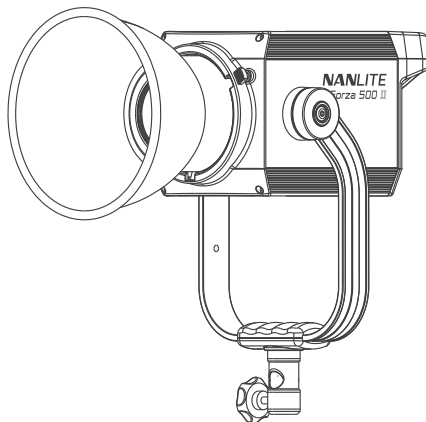

## ■ Technical Data

Rated Power: 560W

Input: DC(Battery)14.4V-26V/12A

AC100-240V 50/60Hz

Color Temperature: 5600K (GM±80)

CRI: 96

TLCI: 97

## Product Details

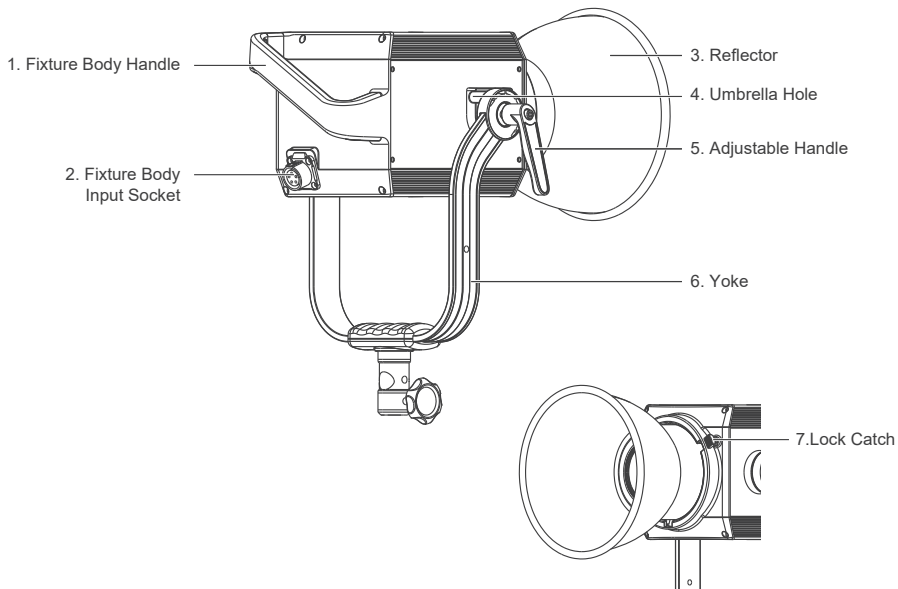

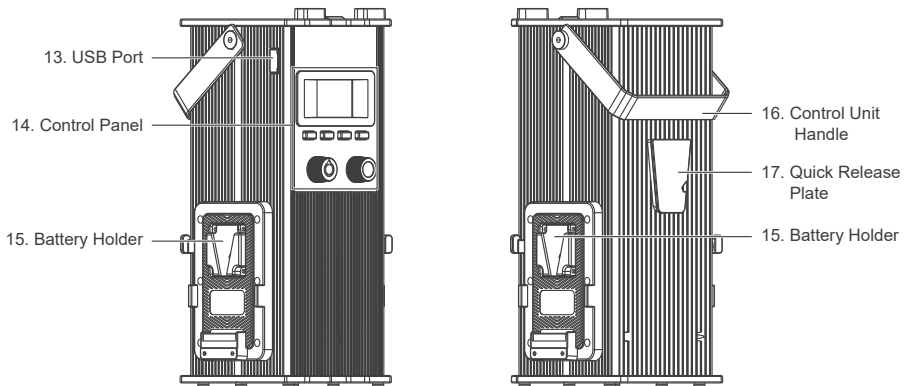
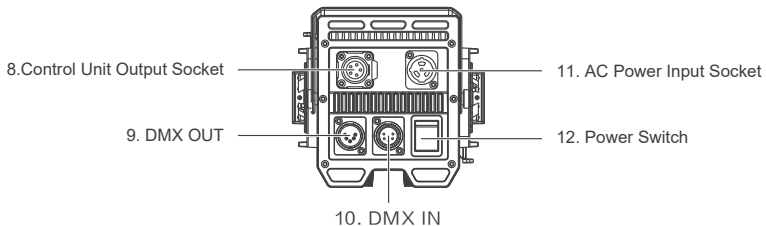



## Detailed Description

1. Fixture body handle: Offer convenient grip for adjusting direction of illumination.
2. Fixture body input socket: To connect a DC cable for connecting between the fixture body and control unit.
3. Reflector: For concentrating light to improve the central illumination.
4. Umbrella hole: For installing/removing an umbrella.
5. Adjustable handle: Tighten or release the tilt movement of the fixture on the yoke.
6. Yoke: Designed for connecting the fixture to the light stand and adjusting the direction of illumination.
7. Lock catch: To lock or release the reflector or other accessories.
8. Control unit output socket: To connect a DC cable for connecting between the fixture body and control unit.
9. DMX OUT: DMX signal output interface.
10. DMX IN: DMX signal input interface.
11. AC power input socket: For connecting AC cable and supplying power to control unit.
12. Power switch: To turn on/off the fixture.
13. USB port: For updating firmware, or supplying power of 5V/0.5A for other devices.
14. Control panel: For displaying various function operations and data.
15. Battery holder: For mounting the 14.4-26V/12A V-mount batteries.
16. Control unit handle: For lifting the control unit.
17. Quick release plate: For mounting the quick release clamp.

## Usage

1. Connection Between Light Fixture, Control Unit and Power Supply.

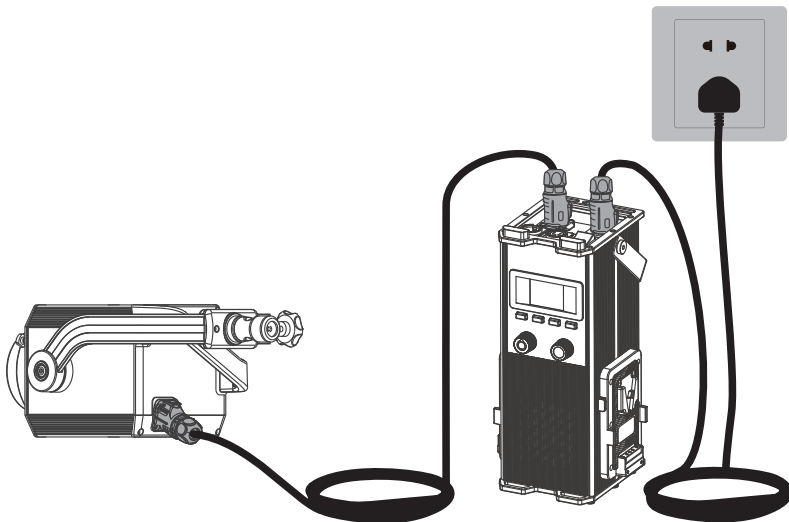

Note: 1.1 When connecting the power supply, please make sure the power voltage are consistent with that indicated on the control unit.

1.2 Make sure to use the included AC power cable and DC connecting cable. The connection between the DC plug and the fixture body input socket should be connected as following.

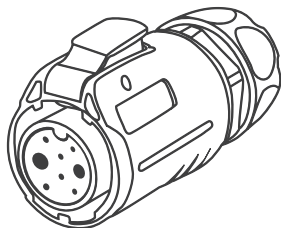
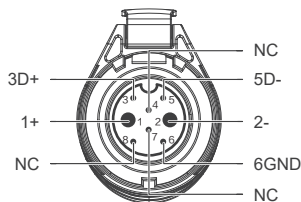
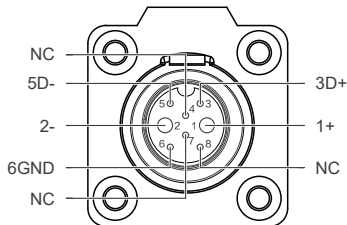

- |                        |        |
|------------------------|--------|
| 1: Power supply + pole | 5: D-  |
| 2: Power supply - pole | 6: GND |
| 3: D+                  | 7: NC  |
| 4: NC                  | 8: NC  |

## 2. Connection Between Light Fixture and Control Unit with Battery

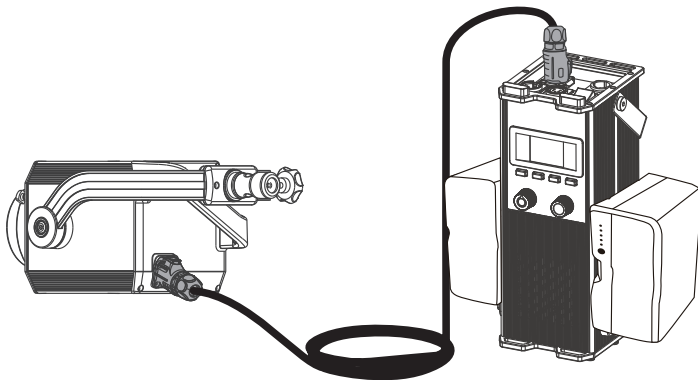

### Note:

- 2.1. When powered by two 26V batteries, the maximum output is 100%.
- 2.2. When powered by two 14.8V batteries, the maximum output is 60%.
- 2.3. Please do not use the 14.8V and 26V batteries simultaneously, or use only one battery to power the fixture.
- 2.4 The batteries are not included and are sold separately.

### 3. Installation and Detachment of Quick Release Clamp

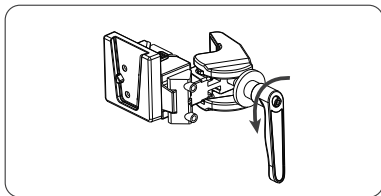

Rotate the adjustable handle to release the clamp.

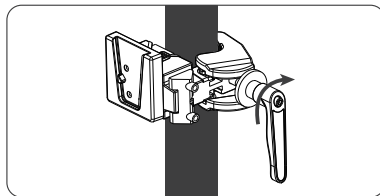

Mount the quick release clamp on the lightstand, then rotate the adjustable handle to tighten the clamp.

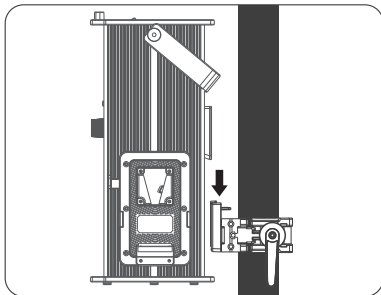

Align the quick release plate on the control unit with the quick release mount on the clamp to mount the control unit on to the clamp.

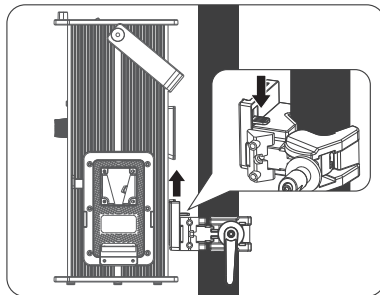

Press the lock catch on the clamp to remove the control unit from the light stand.

#### 4. Installation and Detachment of Reflector

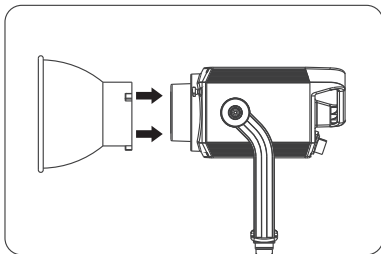

When installing the reflector, align the reflector to the fixture's Bowens mount, rotate the reflector in the direction shown on the fixture until it clicks into place.

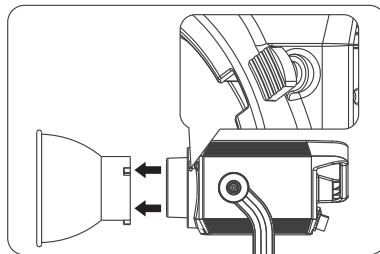

When removing the reflector, push and hold the lock catch and rotate until the reflector is free to be removed from the fixture.

## Remote Control

· Forza 500 II supports DMX/RDM, 2.4G remote control, and includes a built-in bluetooth module as well.

▲ The ADDRESS needs to be set before operating the remote control via DMX/RDM and 2.4G.

1. ADDRESS/DMX, including ADDRESS, DMX MODE, DMX REDUCED CHANNELS, DMX DIMMING CURVE and DMX SMOOTHING.

### 1.1. Address Setting

Press the MENU button to access options.

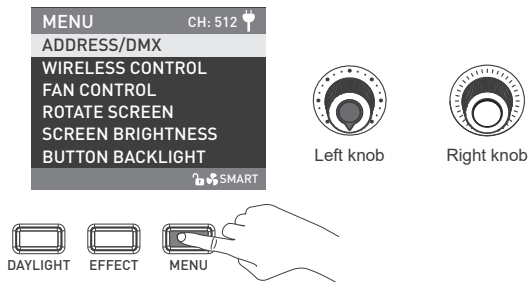

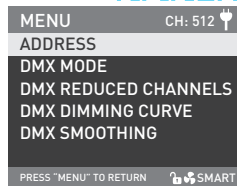
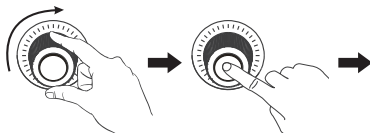
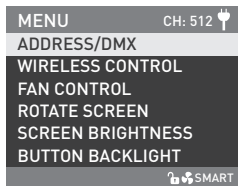

Rotate the "right knob" to ADDRESS/DMX, and press the "right knob" to enter the corresponding secondary menu.

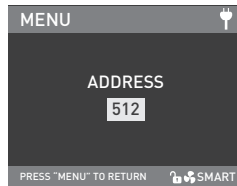
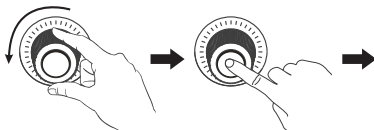
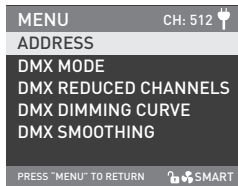

Rotate the "right knob" to ADDRESS, and press the "right knob" to enter the corresponding tertiary menu.

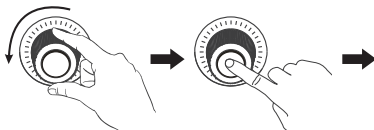
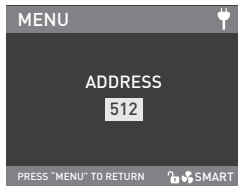

Rotate the "right knob" to select address number and press the "right knob" to set.



1.2. DMX MODE

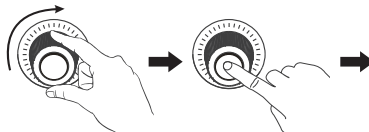
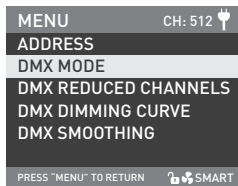

Rotate the "right knob" to DMX MODE, and press the "right knob" to enter the corresponding tertiary menu.

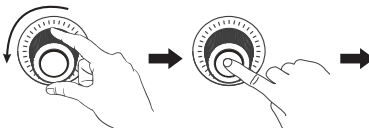
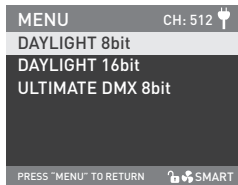

Rotate the "right knob" to select DAYLIGHT 8bit, DAYLIGHT 16bit or ULTIMATE DMX 8bit, and press the "right knob" to set.

## 1.3. DMX REDUCED CHANNELS

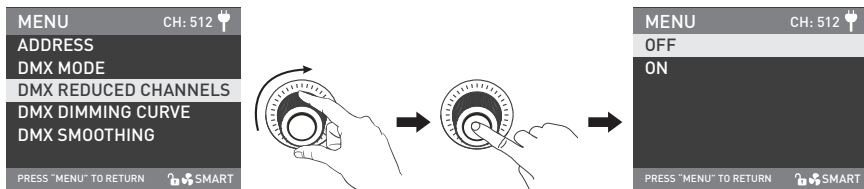

Rotate the "right knob" to DMX REDUCED CHANNELS, and press the "right knob" to enter the corresponding tertiary menu.

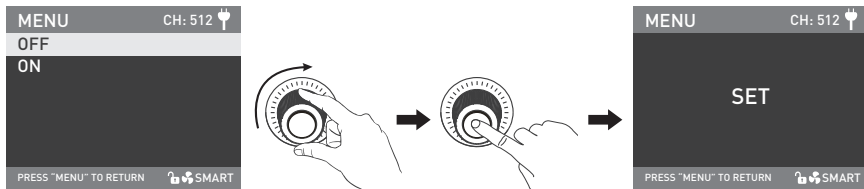

Rotate the "right knob" to select ON or OFF, and press the "right knob" to set.

#### 1.4. DMX DIMMING CURVE

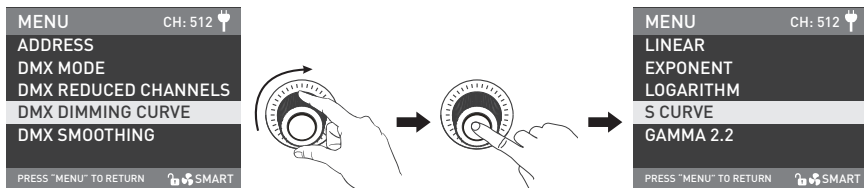

Rotate the "right knob" to DMX DIMMING CURVE, and press the "right knob" to enter the corresponding tertiary menu.

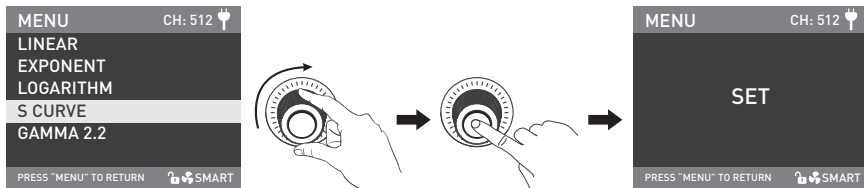

Rotate the "right knob" to select LINEAR, EXPONENT, LOGARITHM, S CURVE or GAMMA 2.2, and press the "right knob" to set.

1.5. DMX SMOOTHING

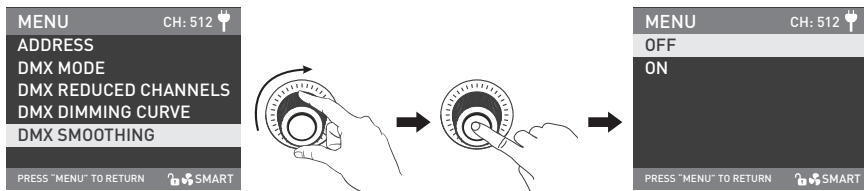

Rotate the "right knob" to DMX SMOOTHING, and press the "right knob" to enter the corresponding tertiary menu.

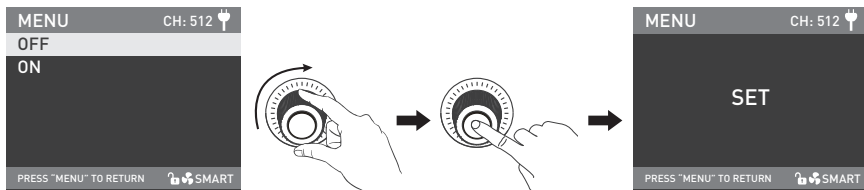

Rotate the "right knob" to select ON or OFF, and press the "right knob" to set.

## 2. DMX Control

2.1. Connect the fixture to the DMX/RDM consoles via DMX cable as shown below:



- 5-pin shielded cable with a diameter not less than 0.3mm must be used for connection between light fixture and DMX/RDM console, or between light fixture and light fixture. XLR plug/socket and the cable should be connected as shown above.
  - Pin1, Pin2, Pin3 for connecting DMX signal. Pin4, Pin5 have no connection.
- ▲NOTE: When connecting DMX, make sure the internal pin is not in contact with the inner case, and pins should not be in contact with each other. The fixture can match the DMX512 (1990) control signal.
- 5-pin and 3-pin XLR plug/socket conversion, the fixture comes with 5-pin XLR plug/socket. If a 3-pin XLR plug is used, please follow the instruction below.

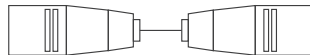
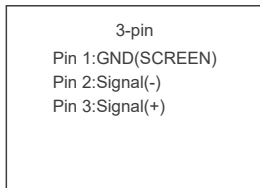
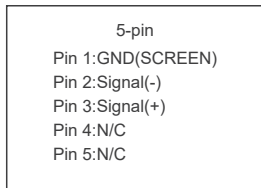

## 2.2. DMX Terminator

In DMX control mode, the DMX output of the last light fixture should be connected with a DMX terminator (not included). The terminator is connected with a 120Ω(OHM) resistor across Pin 2 and Pin 3 (As shown below). This prevents interference caused by DMX signals in the transmitting process.

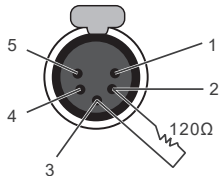

DMX Terminator Connection  
 Connect a 120Ω(OHM) resistor  
 across Pin 2 and Pin 3 in an XLR  
 plug and insert into the DMX  
 OUT socket on the last unit.

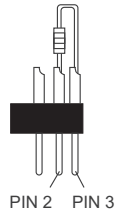

## 2.3. Address Setting of the Light Fixture.

### 2.4 Refer to the DMX reference guide and control the fixture via DMX/RDM console.

(For detailed operation please refer to the DMX/RDM console operation manual.)

Note: DMX reference guide "Forza\_500\_II\_DMX\_REFERENCE\_GUIDE\_EN" is downloadable from [www.nanlite.com](http://www.nanlite.com).

### 3. 2.4G Remote Control

- Forza 500 II can be remotely controlled by 2.4G remote controller and by NANLINK APP via the WS-TB-1 transmitter box, It also has built-in bluetooth module to enable the connection via bluetooth.

Note: ① 2.4G remote controller and WS-TB-1 transmitter box are sold separately.

② The fixture supports 2.4G wireless protocol V1.0 and V2.0. The fixture should be set in V2.0 while using the WS-RC-C2 remote controller, set in V1.0 while using other remote controllers.

### 3.1. WIRELESS CONTROL

Press MENU button to access options, rotate the "right knob" to WIRELESS CONTROL, and press the "right knob" to enter the corresponding secondary menu.

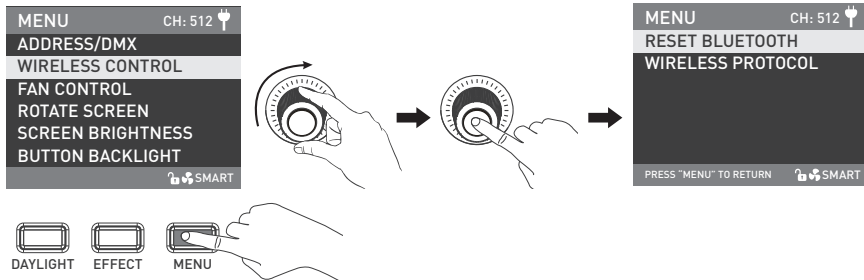

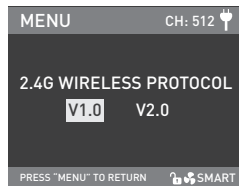
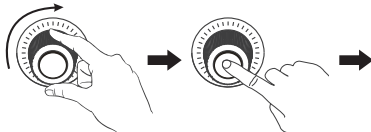

Rotate the "right knob" to WIRELESS PROTOCOL, and press the "right knob" to enter the corresponding tertiary menu.

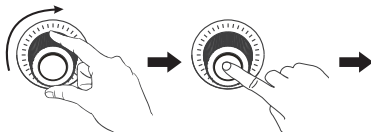

Rotate the "right knob" to select V1.0 or V2.0, and press the "right knob" to set.



### 3.2. RESET BLUETOOTH

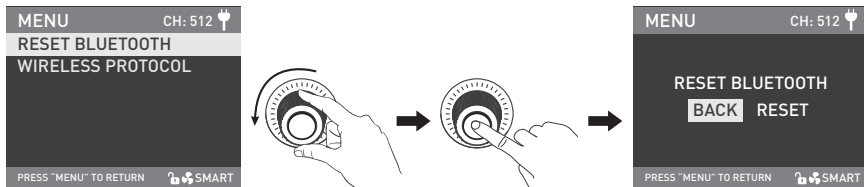

Rotate the "right knob" to RESET BLUETOOTH, and press the "right knob" to enter the corresponding tertiary menu.

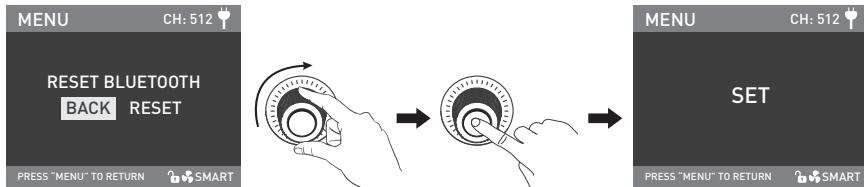

Rotate the "right knob" to select RESET, and press the "right knob" to set.

#### 4. RDM Control

- 4.1. Connect the light fixture to the console with RDM function by using a connection cable, the connecting method is the same as that of DMX/RDM console.
- 4.2. Control the fixture via a console with RDM function. (For specific operation methods, please refer to the RDM console operation manual.)

Note: The UID format of the fixture is as follow:

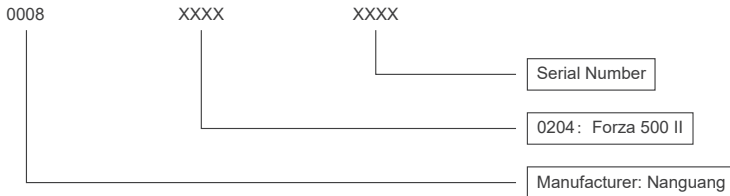

## Operating Instructions

1. Be sure that the power switch of the control unit is off . Now it is safe to connect the control unit and the power cable or attach batteries, and power the unit on, the screen will display "NANLITE".

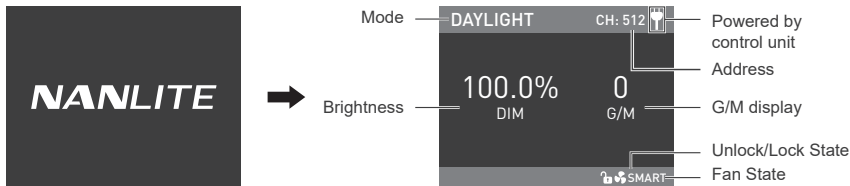

2. DAYLIGHT button: Press the DAYLIGHT button to enter the DAYLIGHT MODE.

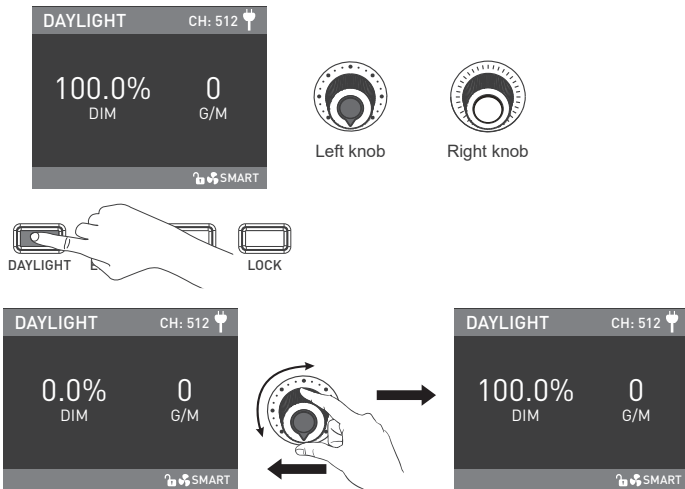

Rotate the "left knob" clockwise to increase brightness while rotate counterclockwise to reduce the brightness. The screen shows the percentage of brightness, DIM range: 0.0%...100.0%.

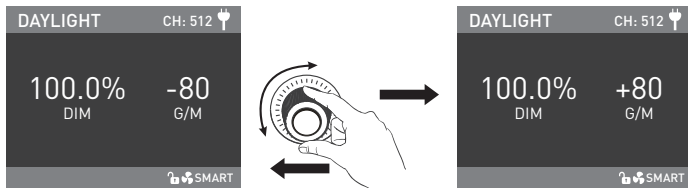

Rotate the "right knob" to set the G/M parameter, the G/M range: -80...+80.

- 2.1. In Effect mode, the DIM parameter is the same as that in DAYLIGHT mode.
- 2.2. In Effect mode, the G/M settings are not synchronized with that in DAYLIGHT mode, the G/M range is the same as that in DAYLIGHT mode.
- 2.3. When the fixture function is unlocked, in any mode, press the "left knob" to turn off the fixture, and the DIM percentage on the screen will be 0.0%. Press again to restore the fixture to its previous state. Press continuously to switch the fixture between on and off.

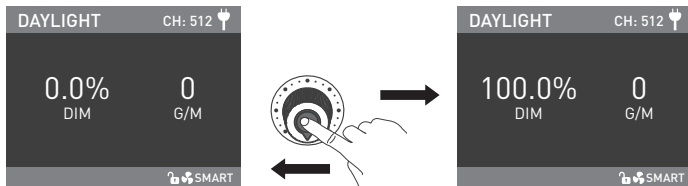

Press the "left knob" to turn off the fixture. Press again to restore the fixture to its previous state.

3. EFFECT Button: Press the EFFECT button to enter EFFECT MODE.

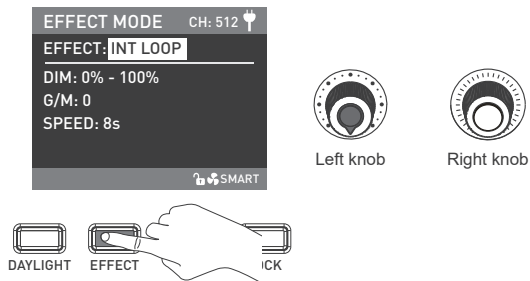

- Forza 500 II has built-in effects including INT LOOP, FLASH, PULSE, STORM AUTO, STORM MANUAL, TV, PAPARAZZI, CANDLE/FIRE, BAD BULB, FIREWORK, EXPLOSION AUTO, EXPLOSION MANUAL and WELDING.

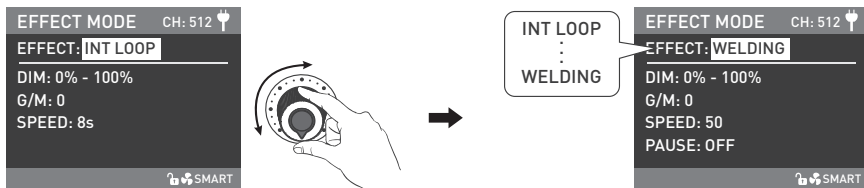

Rotate the "left knob" to select the effect.

### 3.1. INT LOOP

INT LOOP setting, rotate the "right knob" to select DIM, G/M or SPEED (range from: 2s -30s), and rotate the "left knob" to set the corresponding parameters.

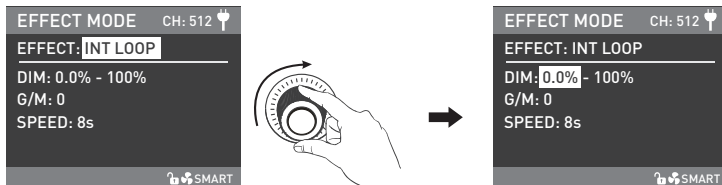

Rotate the "right knob" to select DIM, G/M or SPEED.

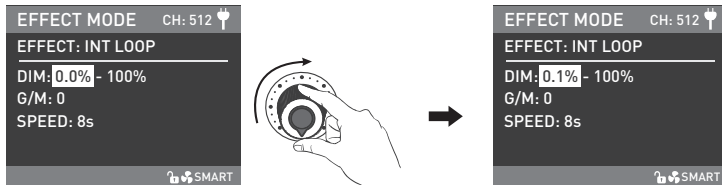

Rotate the "left knob" to set the corresponding parameters.

### 3.2. FLASH

FLASH setting, rotate the "right knob" to select DIM, G/M, INTERVALS (range from: 0.1s -10s) or FLASH RATIO (range from: 0% -100%), and rotate the "left knob" to set the corresponding parameters.

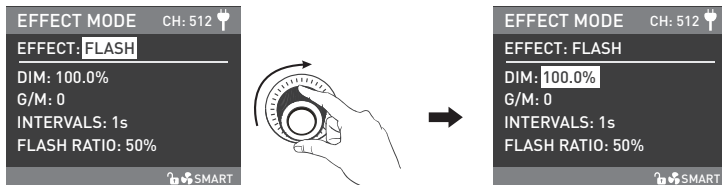

Rotate the "right knob" to select DIM, G/M, INTERVALS or FLASH RATIO.

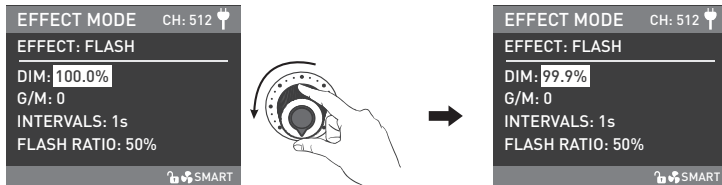

Rotate the "left knob" to set the corresponding parameters.

### 3.3. PULSE

PULSE setting, rotate the "right knob" to select DIM, G/M or PULSES/MIN (range from: 1-240), and rotate the "left knob" to set the corresponding parameters.

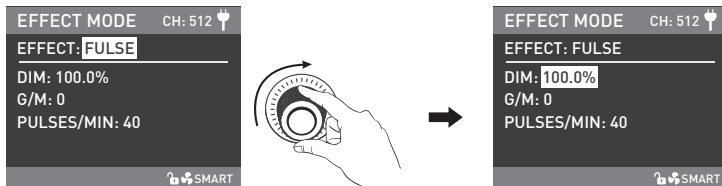

Rotate the "right knob" to select DIM, G/M or PULSES/MIN.

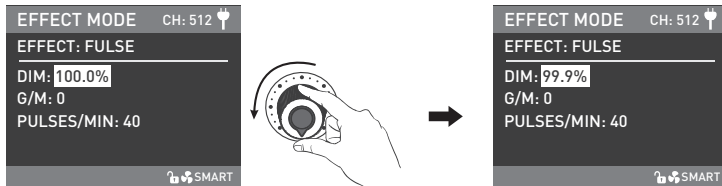

Rotate the "left knob" to set the corresponding parameters.



### 3.4. STORM AUTO

STORM AUTO setting: rotate the "right knob" to select DIM or INTVL RANGE (range from: 1s ... 60s) , and rotate the "left knob" to set the corresponding parameters.

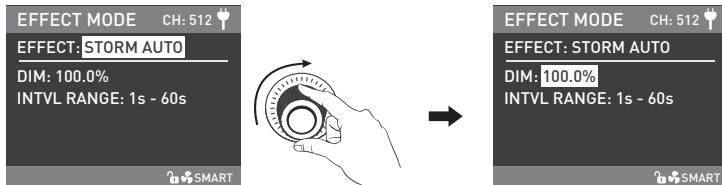

Rotate the "right knob" to select DIM or INTVL RANGE.

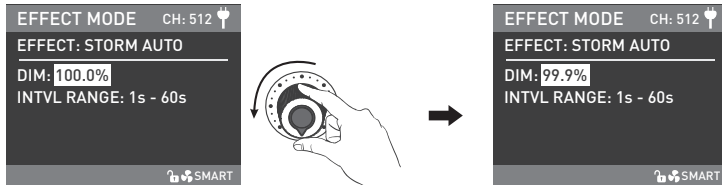

Rotate the "left knob" to set the corresponding parameters.

## 3.5. STORM MANUAL

STORM MANUAL setting: rotate the "right knob" to select DIM, and rotate the "left knob" to set the corresponding parameters, press the "right knob" to trigger the storm effect.

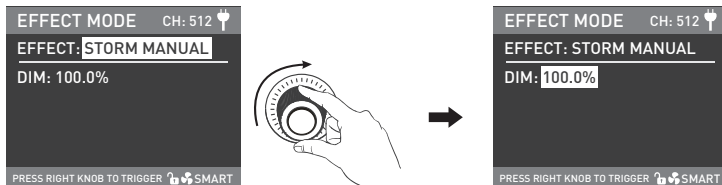

Rotate the "right knob" to select DIM.

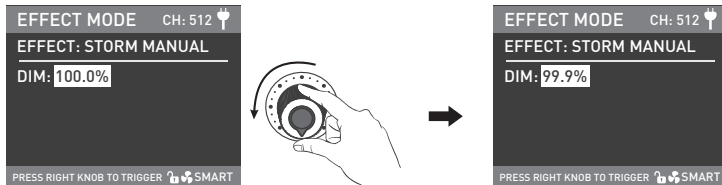

Rotate the "left knob" to set the corresponding parameters.

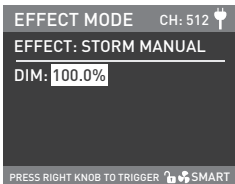

Press the "right knob" to trigger the storm effect.

### 3.6. TV

TV setting: rotate the "right knob" to select DIM, G/M or SPEED (range from: 1...100), and rotate the "left knob" to set the corresponding parameters.

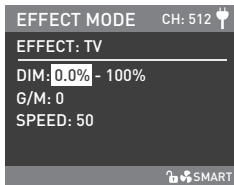
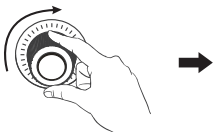
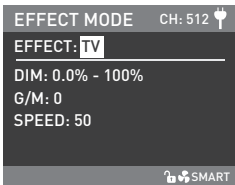

Rotate the "right knob" to select DIM, G/M or SPEED.

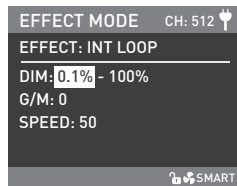
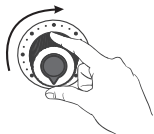
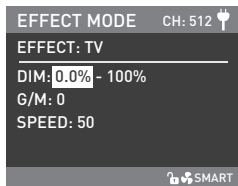

Rotate the "left knob" to set the corresponding parameters.

### 3.7. PAPARAZZI

PAPARAZZI setting: rotate the "right knob" to select DIM, G/M or SPEED (range from: 1...100), and rotate the "left knob" to set the corresponding parameters.

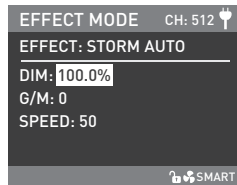
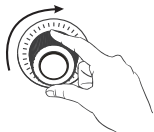
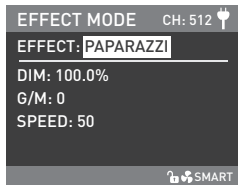

Rotate the "right knob" to select DIM, G/M or SPEED.

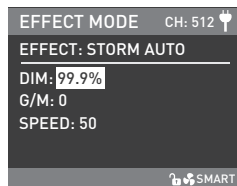
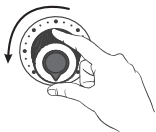
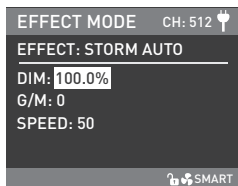

Rotate the "left knob" to set the corresponding parameters.

### 3.8. CANDLE/FIRE

CANDLE/FIRE setting: rotate the "right knob" to select DIM, G/M or SPEED (range from: 1...100), and rotate the "left knob" to set the corresponding parameters.

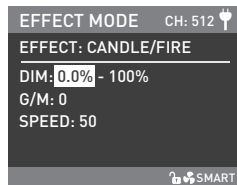
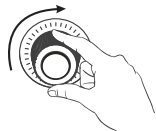
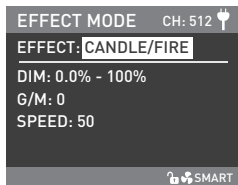

Rotate the "right knob" to select DIM, G/M or SPEED.

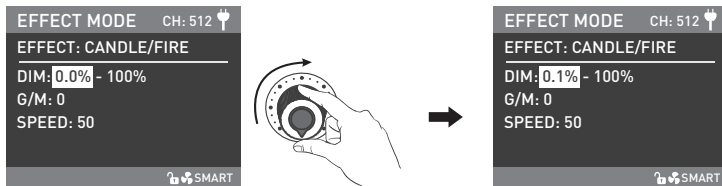

Rotate the "left knob" to set the corresponding parameters.

### 3.9. BAD BULB

BAD BULB setting: rotate the "right knob" to select DIM, G/M, INTENSITY (range from: 1...100) or SPEED (range from: 1...100), and rotate the "left knob" to set the corresponding parameters.

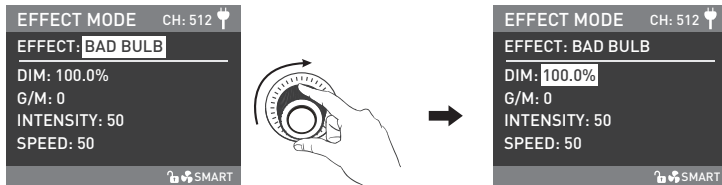

Rotate the "right knob" to select DIM, G/M, INTENSITY or SPEED.

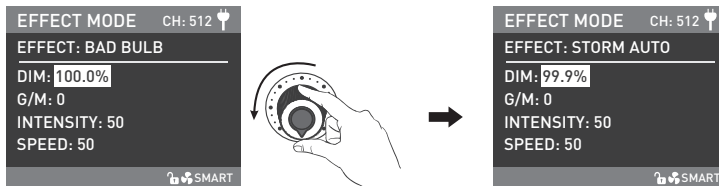

Rotate the "left knob" to set the corresponding parameters.

### 3.10. FIREWORK

FIREWORK setting: rotate the "right knob" to select DIM, G/M, SPEED (range from: 1...100) or DECAY(range from: 1...100), and rotate the "left knob" to set the corresponding parameters.

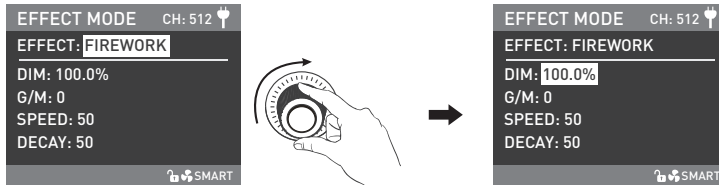

Rotate the "right knob" to select DIM, G/M, SPEED or DECAY.

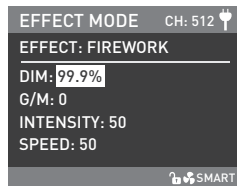
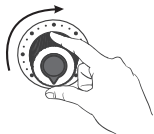
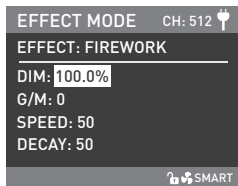

Rotate the "left knob" to set the corresponding parameters.

### 3.11. EXPLOSION AUTO

EXPLOSION AUTO setting: rotate the "right knob" to select DIM, G/M, SPEED (range from: 1...100) or DECAY (range from: 1...100), and rotate the "left knob" to set the corresponding parameters.

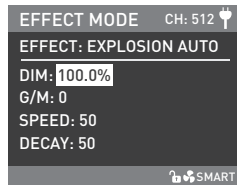
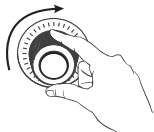
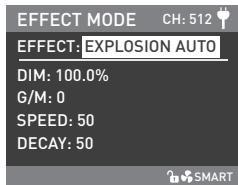

Rotate the "right knob" to select DIM, G/M, SPEED or DECAY.



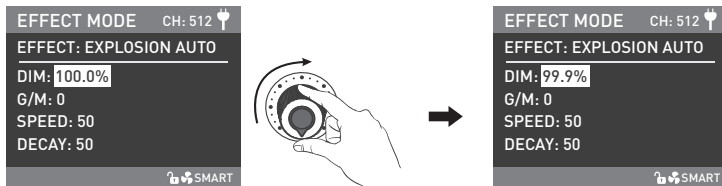

Rotate the "left knob" to set the corresponding parameters.

### 3.12. EXPLOSION MANUAL

EXPLOSION MANUAL setting: rotate the "right knob" to select DIM, G/M or DECAY (range from: 1...100), and rotate the "left knob" to set the corresponding parameters, press the "right knob" to trigger the explosion effect.

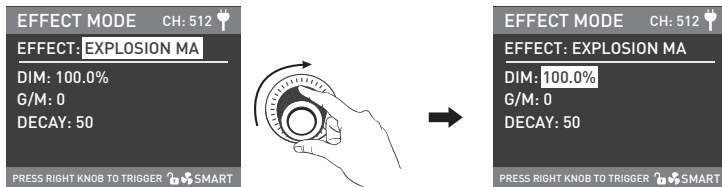

Rotate the "right knob" to select DIM, G/M or DECAY.

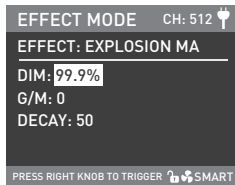
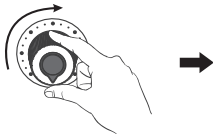
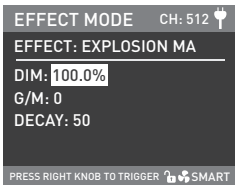

Rotate the "left knob" to set the corresponding parameters.

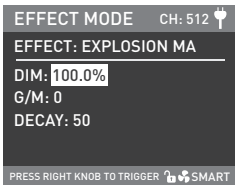

Press the "right knob" to trigger the explosion effect.

### 3.13. WELDING

WELDING setting: rotate the "right knob" to select DIM, G/M, SPEED (range from: 1...100) or PAUSE (ON/OFF), and rotate the "left knob" to set the corresponding parameters.

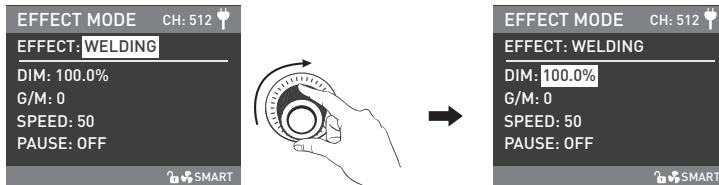

Rotate the "right knob" to select DIM, G/M, SPEED or PAUSE.

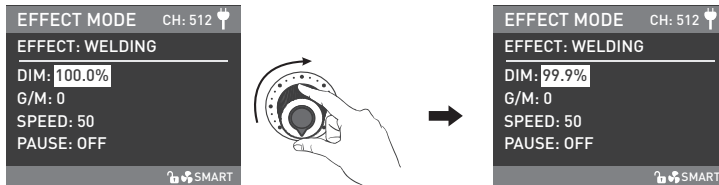

Rotate the "left knob" to set the corresponding parameters.

NOTE: When the PAUSE is on, the welding effect will pause.

- Lighting effects and additional functionality will be probably updated with later firmware version. Detailed information is subject to the instruction of firmware function.

4. MENU Button: Press the MENU button to enter the interface of menu, the menu includes, ADDRESS/DMX, WIRELESS CONTROL, FAN CONTROL, ROTATE SCREEN, SCREEN BRIGHTNESS, BUTTON BACKLIGHT, LANGUAGE, FIRMWARE UPDATE and VERSION. The operations on the menu interface are as follow:

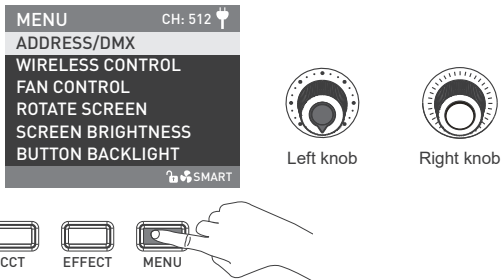

- Rotate the "right knob" to select the options, press the "right knob" to enter the corresponding secondary menu, and rotate the "right knob" to select the corresponding parameters, then press the "right knob" to set. Press the MENU button to return to the previous menu.

#### 4.1. ADDRESS/DMX

For detailed operations please refer to P10.

#### 4.2. WIRELESS CONTROL

For detailed operations please refer to P18.

### 4.3. FAN CONTROL

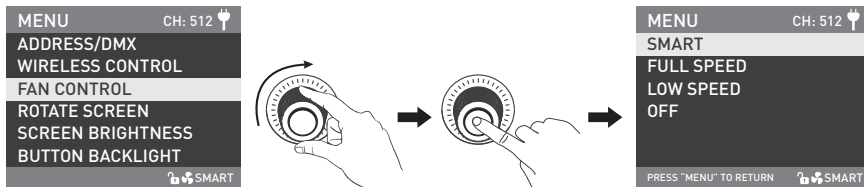

Rotate the "right knob" to FAN CONTROL, and press the "right knob" to enter the corresponding secondary menu.

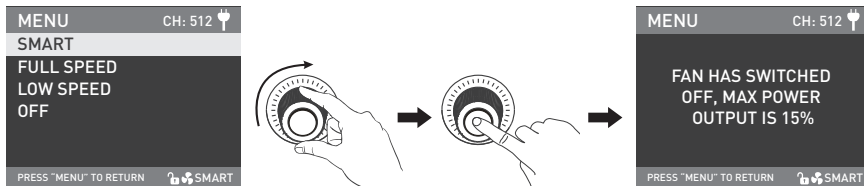

Rotate the "right knob" to select SMART, FULL SPEED, LOW SPEED or OFF, and press the "right knob" to set.

- Note:
- When the fan is off, the interior fan will stop working, and at this moment the maximum power output of the fixture is 15%.
  - When the fan is in LOW SPEED state, the maximum power output of the fixture is 50%.
  - When the fan is in SMART or FULL SPEED state, the maximum power output of the fixture is 100%.

## 4.4. ROTATE SCREEN

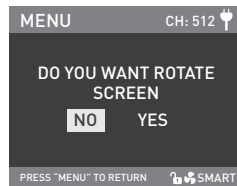
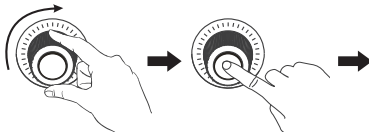
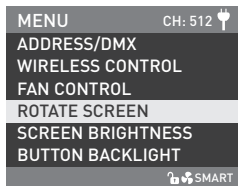

Rotate the "right knob" to ROTATE SCREEN, and press the "right knob" to enter the corresponding secondary menu.

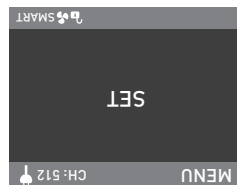
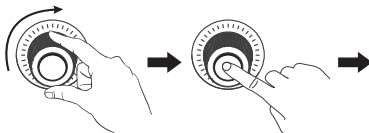
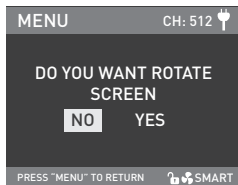

Rotate the "right knob" to select YES or NO, and press the "right knob" to set.

## 4.5. SCREEN BRIGHTNESS

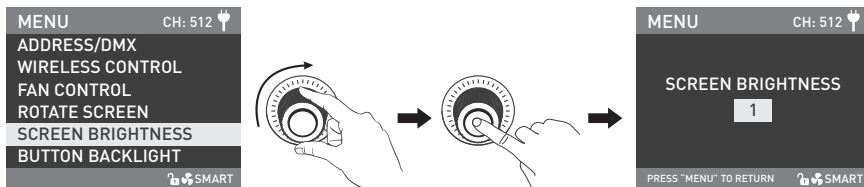

Rotate the "right knob" to SCREEN BRIGHTNESS, and press the "right knob" to enter the corresponding secondary menu.

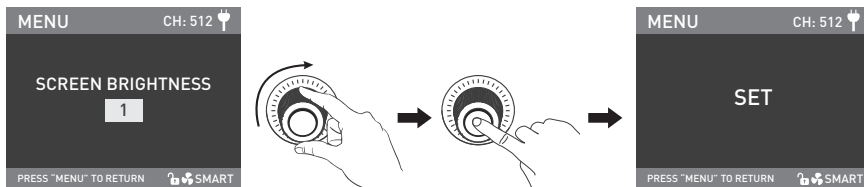

Rotate the "right knob" to select the screen brightness, and press the "right knob" to set.

4.6. BUTTON BACKLIGHT

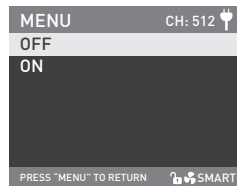
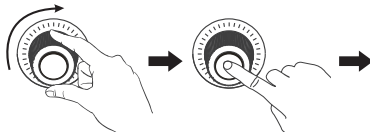
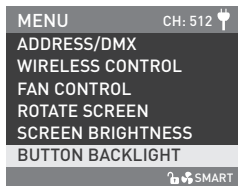

Rotate the "right knob" to **BUTTON BACKLIGHT**, and press the "right knob" to enter the corresponding secondary menu.

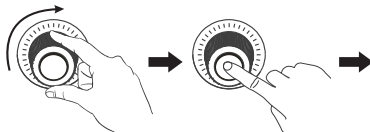
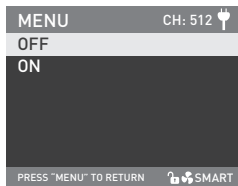

Rotate the "right knob" to select **ON** or **OFF**, and press the "right knob" to set.



## 4.7. LANGUAGE

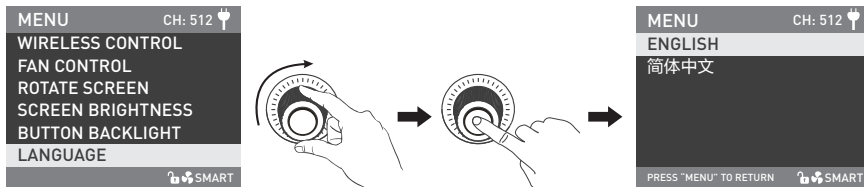

Rotate the "right knob" to the LANGUAGE, and press the "right knob" to enter the corresponding secondary menu.

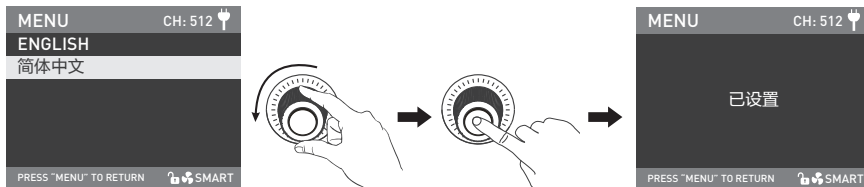

Rotate the "right knob" to ENGLISH or 简体中文, and press the "right knob" to set.

#### 4.8. FIRMWARE UPDATE

- Download the firmware files of the light fixture and control unit, and put into the root directory of the USB drive(ensure the firmware versions match), and connect the USB drive to the USB port.

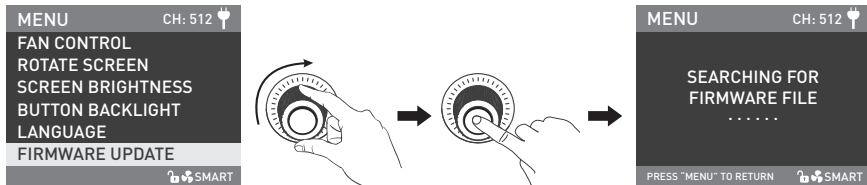

Rotate the "right knob" to FIRMWARE UPDATE, press the "right knob" to enter the interface to search for the firmware files.

Note:

- ① Please do not rename the updated file.
- ② Ensure the USB drive is formatted to FAT, FAT32 or exFAT.
- ③ If prompted that "PLEASE CONNECT THE LAMP HEAD TO THE CONTROLLER BEFORE FIRMWARE UPDATE", please check whether the light fixture is connected to the control unit or whether the connection is loose.
- ④ If prompted that "THE VERSIONS OF THE TWO FIRMWARE FILES DON'T MATCH, PLEASE CHECK THE FILES AND TRY AGAIN", please check whether the versions of the two firmware files are consistent.
- ⑤ If prompted that "MISSING PARTS OF FIRMWARE FILES, PLEASE CHECK THE FILES AND TRY AGAIN", please check whether there are two firmware files in the USB drive.

- ⑥ If prompted that "NO FIRMWARE FOUND", please check whether the firmware files are correct, whether the firmware files are stored in the root directory of the USB drive, or whether the USB drive format is FAT, FAT32 or exFAT.
- ⑦ If all the above steps are done and the firmware files still cannot be found, try to format the USB drive again.
- ⑧ If the light fixture still cannot identify the USB drive, please replace the USB drive.

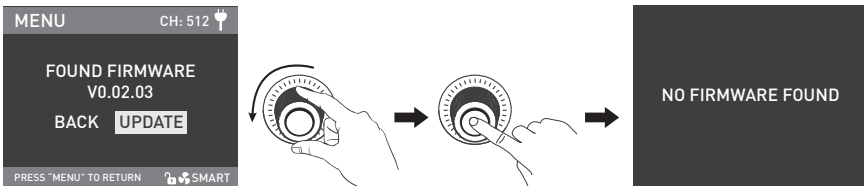

After finding the firmware file, enter the firmware update selection interface, rotate the "right knob" to select UPDATE, and press the "right knob" to make update. After update, the light fixture will automatically restart.

#### 4.9. VERSION

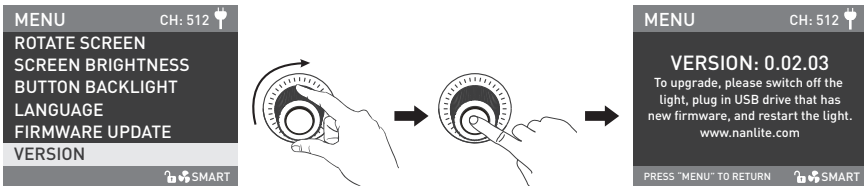

Rotate the "right knob" to VERSION, and press the "right knob" to check the current version.

5. LOCK button: Long press the LOCK button to lock the current settings. At this moment, operating the buttons or adjusting the knobs can not change the current settings. Long press the LOCK button again to release the lock state.

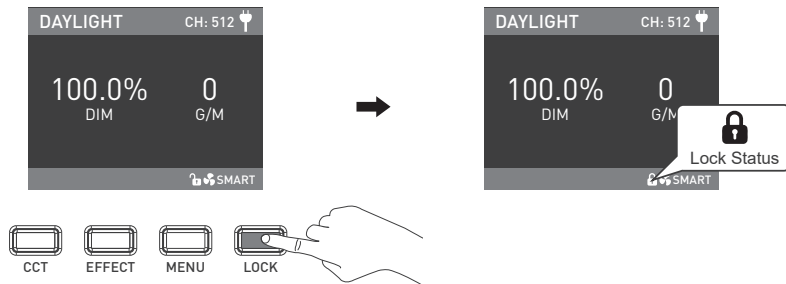

6. When the fixture is not in use, please turn off the power switch.

## Safety Precautions

1. Please check for possible damage caused in transit after opening the package. Please do not use if damage is found. And contact with the distributor or manufacturer as soon as possible.
2. Please do not use a power cable with damaged insulation. Please do not unplug too hard or drag the power cable directly.
3. Please make sure the voltage of power supply accords with the voltage specified on the fixture before installation.
4. Please turn the fixture off when it is not in use or before cleaning.
5. Please keep the fixture safely stored and away from children.







## Notice

1. Please remove the COB protective cap before using the fixture.
2. Please do not look directly at the emitter when the fixture is on .
3. Please do not place the fixture near any flammables and explosives.
4. Please do not place any object on the fixture or allow liquid to flow inside the fixture.
5. Please do not place the fixture near any flammable or volatile substances like alcohol or gasoline.
6. Please do not use strong detergent for cleaning. Please wipe off the dirt by using a cloth with neutral cleanser when cleaning the fixture.
7. Please set up the fixture in a dry and well-ventilated place. Please do not use it in any humid, dusty or overheated environment. Meanwhile, please also check whether the fan and vent are unimpeded.
8. Please do not disassemble the fixture at will to repair by yourself. Qualified professionals should conduct maintenance under the condition of strictly following the operating procedures described in this manual.
9. Please do not cover the vents when using, to avoid affecting heat dissipation, and resulting in damage. Please pay attention to anti-scald when using the fixture for a long time, since the surface temperature of fixture will be high.

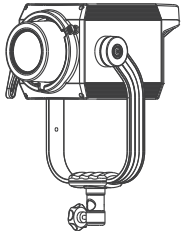
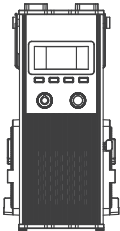
## General Fault Detection and Diagnosis

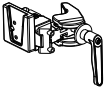
Fault Detection	Diagnosis
The fixture won't boot up properly.	<ol style="list-style-type: none"> <li>1. Please check whether the connection between power supply and cable or fixture are loose.</li> <li>2. Please check whether the voltage value is within the specified range.</li> </ol>
The fixture can be operated manually, but DMX control is not working.	<ol style="list-style-type: none"> <li>1. Please check whether the DMX address setting of the fixture is correct.</li> <li>2. Please check whether the DMX signal cable is connected correctly and without damaged.</li> </ol>
The display screen is on, but fixture cannot be operated.	Please check if the screen shows "🔒", and press and hold the "LOCK" button for 2s to unlock.
The fan doesn't work.	<ol style="list-style-type: none"> <li>1. Please check if the fan is OFF.</li> <li>2. If the screen displays "Fan abnormal", please contact with the supplier or manufacturer for replacement.</li> </ol>
If the failure is not resolved after troubleshooting, please contact place of purchase.	

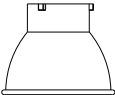
## What's in the box? Please kindly check.

Forza 500 II x 1	Control Unit x 1	AC Power Cable x 1	DC Connection Cable x 1
			
		Quick Release Clamp x 1	COB Protective Cap x 1
			
Carrying Bag x 1	Reflector x 1	DMX Reference Guide x 1	User Manual x 1
			

This manual has been compiled according to the rigorous testing for Nanlite products. Product designs are subject to change without prior notice. The latest version of the manual for this product is downloadable at [www.nanlite.com](http://www.nanlite.com).

Version: V1 2022-12-31

# NANLITE

+86-754-85751187

+86-754-85300887

service@nanlite.com

Dongli Section, Highway 324, Chenghai, Shantou City, Guangdong Province, China

[www.nanlite.com](http://www.nanlite.com)