

NANLITE

Forza 60C
USER MANUAL

Guangdong NanGuang Photo&Video Systems Co., Ltd

Forza 60C LED RGBLAC Spot Light

■ Product Diagram

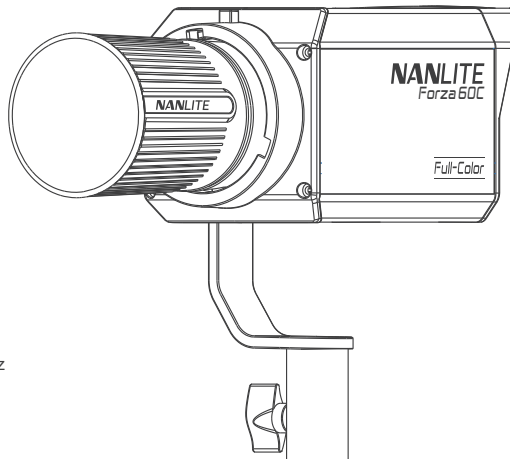

■ Technical Data

Rated power: 88W

Input voltage/current: DC15V/6A Max
AC100-240V 50/60Hz

Color Temperature: 1800K-20000K

CRI: Average 96

TLCI: Average 95

Product Details

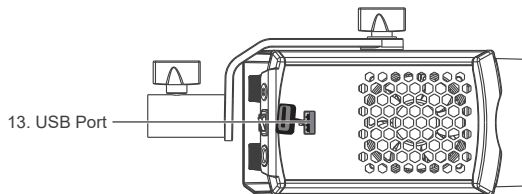
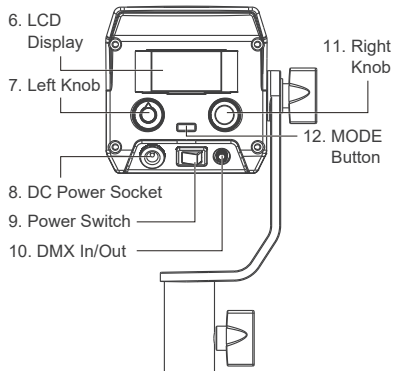
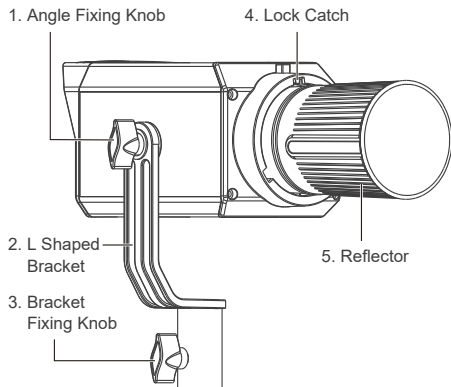

Detailed Description

1. Angle Fixing Knob: Allows for adjusting and fixing the direction of light in tilt.
2. L Shaped Bracket: Designed for connecting the light to the light stand and adjusting the direction of light.
3. Bracket Fixing Knob: For locking the light fixture and stand, and adjusting the horizontal direction of light.
4. Lock Catch: For mounting and dismounting reflector and other accessories.
5. Reflector: For gathering light to improve the central illumination.
6. LCD Display: For displaying various function operations and data.
7. Left Knob: For adjusting the DIM and scrolling through different selections.
8. DC Power Socket: DC power input.
9. Power Switch: For switching on/off the fixture.
10. DMX In/Out: Connect to 1/2 DMX adapter cable for DMX signal input and output
(Note: 1/2 DMX adapter cable is sold separately).
11. Right Knob: For selecting various functions.
12. MODE Button: For switching between CCT/HSI/EFFECT/MENU modes.
13. USB Port: For updating the firmware.

Usage

1. Installation of the Reflector

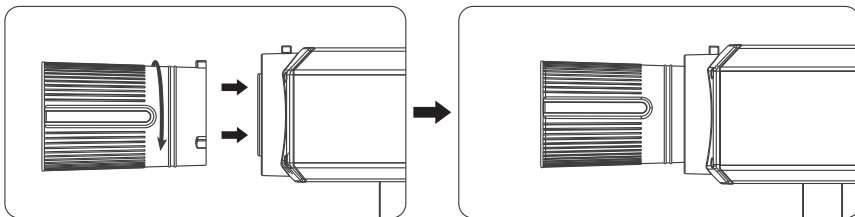

① When installing the reflector, ensure its mounting points align with the slots on the light fixture. When the mounting points and slots are aligned, push the reflector in place and rotate it in the direction shown on the light until it clicks into place.

Note: This light is with FM mount, so please use accessories with FM mount. If the accessories with Bowens mount are needed, please mount after installing the Bowens mount adapter.

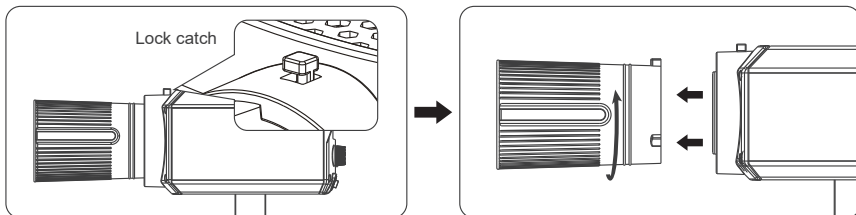

② When removing the reflector, push and hold the lock catch and rotate until the reflector is free to be removed from the fixture.

2. Installation of Bowens Mount Adapter

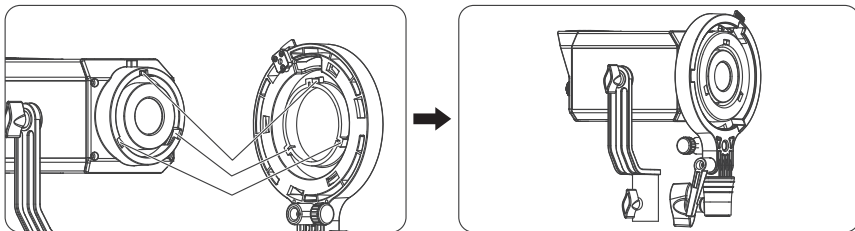

① When installing the adapter, ensure its mounting points align with the slots on the light fixture, rotate it according to the direction shown on the light until the adapter is put into place.

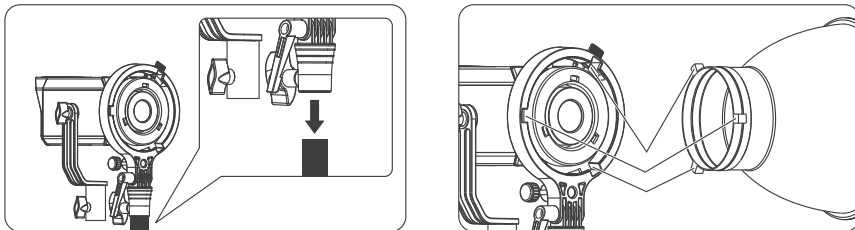

② Mount the adapter on the light stand.

③ Ensure the Bowens mount accessories align with the slots of the Bowens mount adapter, rotate it according to the direction shown on the adapter until the accessories are put into place.

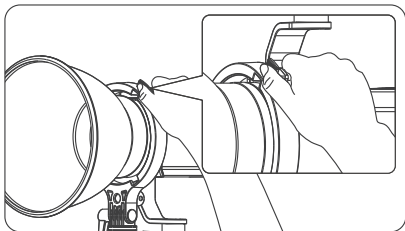

- ④ When removing the accessory, push and hold the release button on the adapter and rotate according to the direction shown on the adapter until the accessory is free to be removed from the adapter.

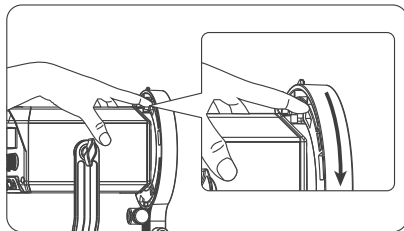

- ⑤ When removing the adapter, push and hold the lock catch on the fixture and rotate according to the direction shown on the light until the adapter is free to be removed from the light.

3. Installation of Battery Grip

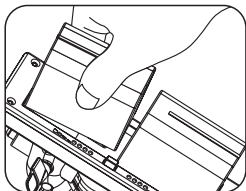

- ① Slide 2*NP-F batteries onto the battery holder

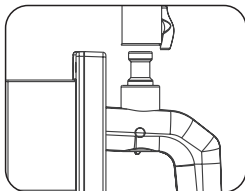

- ② Mount the light onto the receiver on the grip and lock.

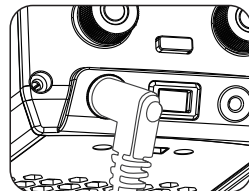

- ③ Ensure the light is switched off, connect DC plug into the DC power socket.

Remote Control

· Forza 60C supports 2.4G remote control, DMX/RDM control, and includes a built-in bluetooth module as well.

▲ Address code need to be pre-set for 2.4G remote control, DMX/RDM control solutions.

1. Address Code and DMX Mode Setting

①Address Code Setting



Press the MODE button to enter the menu.

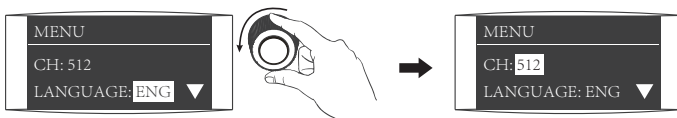

Rotate "Right knob" to CH.



Rotate "Left knob" to select address code.

②DMX Mode Setting



Press the MODE button to enter the menu.

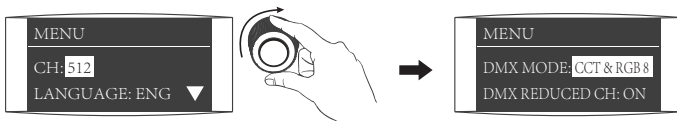

Rotate "Right knob" to DMX MODE.



Rotate "Left knob" to select the desired DMX mode.

③DMX Reduced Channel Setting



Press the MODE button to enter the menu.

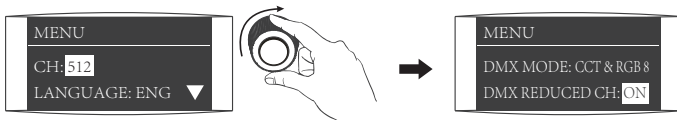

Rotate "Right knob" to DMX REDUCED CH.



Rotate "Left knob" to select ON or OFF.

2. DMX Control

① Connect the fixture to the DMX/RDM consoles via DMX cable as shown below:



② DMX Terminator

In DMX control mode, the DMX output of the last light fixture should be connected with a DMX terminator (not included). The terminator is connected with a 120Ω(OHM) resistor across Pin 2 and Pin 3 (As shown below). This prevents interference caused by DMX signals in the transmitting process.

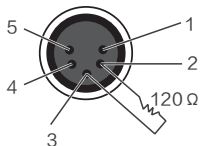

DMX Terminator Connection
Connect a 120Ω(OHM) resistor across Pin 2 and Pin 3 in an XLR plug and insert into the DMX OUT socket on the last unit.

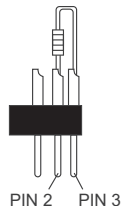

- ③Address Setting of the Light Fixture.
- ④Refer to the DMX reference guide and control the light via DMX/RDM console.
(For detailed operation please refer to the DMX/RDM console operation manual.)

Note: DMX reference guide "Forza_60C_DMX_REFERENCE_GUIDE_EN" is downloadable from www.nanlite.com.



Please scan the QR to check and download the latest DMX reference guide.

3. RDM Control

- ①Connect the light fixture to the console with RDM function by using a connection cable, the connection method is the same as that with a DMX/RDM console.
- ②Control the fixture via a console with RDM function. (For specific operation methods, please refer to the RDM console operation manual.) Note: The UID format of the fixture is as follows:

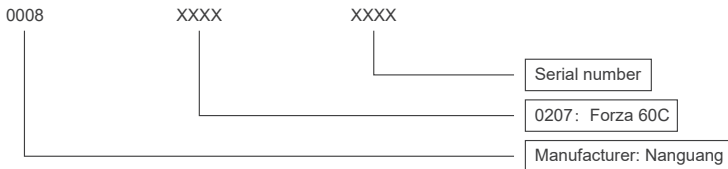

4. 2.4G Remote Control

- Set the address of the 2.4G remote controller to be consistent with the light fixture, enabling the fixture to be remotely controlled by 2.4G remote controller or by APP via the transmitter box.

Note: ①2.4G remote controller and transmitter box are sold separately.

- ②The fixture supports the 2.4G wireless protocol V1.0 and V2.0. Please set fixture to V2.0 while using WS-RC-C1 or WS-RC-C2 remote controller. Please set fixture to V1.0 while using other remote controllers.



Press MODE button to enter the menu.



Rotate "Right knob" to WIRELESS PROTOCOL.



Rotate "Left knob" to select V1.0 or V2.0.

Operating Instructions

1. Connection between fixture and power adapter.

- ① First ensure that the power switch of the fixture is in the "off" position. Now turn on the light, the LCD screen will display all the relevant information for the fixture.

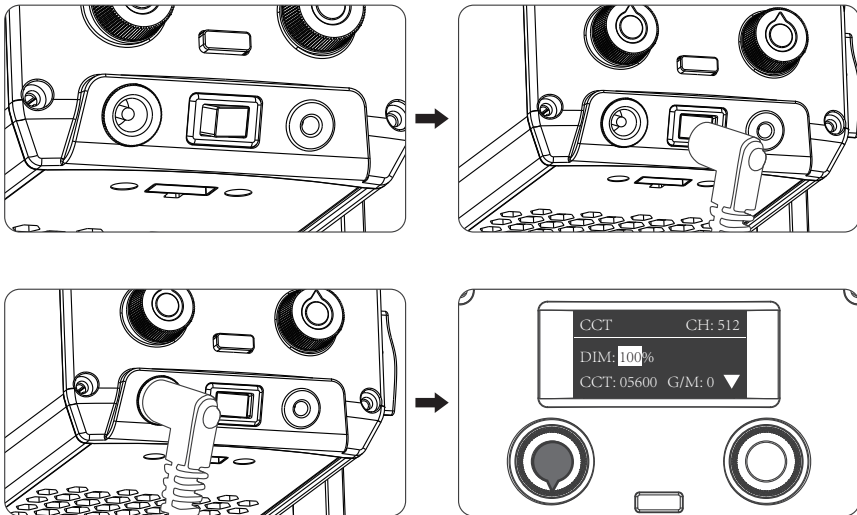

2. CCT mode setting: Press MODE button to CCT mode, rotate "Right knob" to select from DIM, CCT and G/M, rotate "Left knob" to adjust the value of DIM, CCT and G/M. DIM range: 000%...100%, CCT range: 01800K...20000K, G/M range: -100...+100

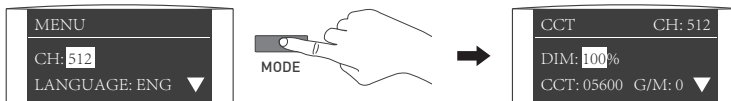

Press MODE button to CCT mode.

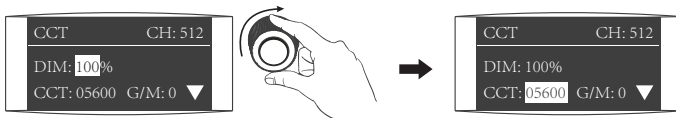

Rotate "Right knob" to select from DIM, CCT and G/M.

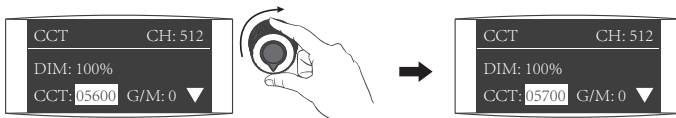

Rotate "Left knob" to adjust the value of DIM, CCT and G/M.

Note: ①In other modes, the adjustable range of DIM, CCT and G/M are the same as CCT mode.

②When the fixture function is unlocked, in CCT/HSI mode, press the "Left knob" to turn off the light, the brightness percentage on the screen is 0.0% in this case. Press again to restore the light to its previous state, and press continuously to switch between on and off.

3. HSI mode setting, press MODE button to HSI mode, rotate "Right knob" to select from DIM, HUE and SAT, rotate "Left knob" to adjust the value of DIM, HUE and SAT. DIM range: 000%...100%, HUE range: 000...360, SAT range: 000...100.



Press MODE button to HSI mode.

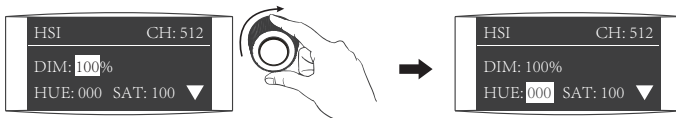

Rotate "Right knob" to select from DIM, HUE and SAT.

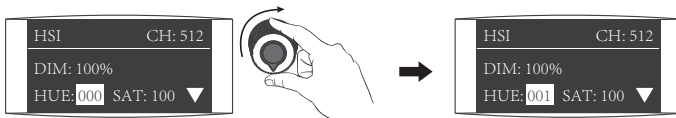

Rotate "Left knob" to adjust the value of DIM, HUE and SAT.

Note: In other modes, the adjustable range of DIM, HUE and SAT are the same as HSI mode.

4. Effect mode setting, press MODE button to EFFECT, Forza 60C has built-in effects including Hue Loop, CCT Loop, INT Loop, CCT Flash, HUE Flash, CCT Pulse, Hue Pulse, Storm, Police Car, TV, Paparazzi, Candle/Fire, Disco, Bad Bulb, Firework, Explosion and Welding.

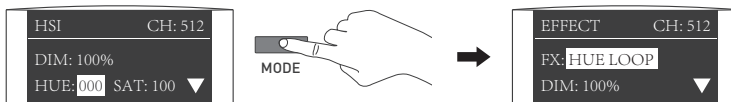

Press MODE button to EFFECT.



Rotate "Right knob" to select the desired effect.

① HUE LOOP

To set the HUE LOOP, rotate "Right knob" to select from DIM, HUE and SPD (range: 02S...30S), then rotate "Left knob" to set the corresponding parameters.

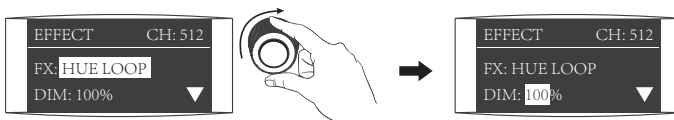

Rotate "Right knob" to select from DIM, HUE and SPD.



Rotate "Left knob" to set the corresponding parameters.

② CCT LOOP

To set the CCT LOOP, rotate "Right knob" to select from DIM, cct and SPD (SPD range: 02S...30S), then rotate "Left knob" to set the corresponding parameters.

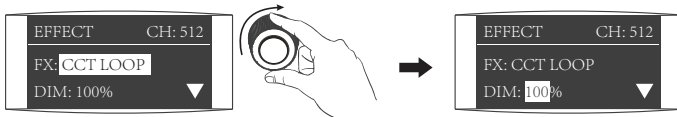

Rotate "Right knob" to select from DIM, cct and SPD.



Rotate "Left knob" to set the corresponding parameters.

③INT LOOP

To set the INT LOOP, rotate "Right knob" to select from DIM, SPD (range: 02S...30S) and CLR (includes CCT and HUE), then rotate "Left knob" to set the corresponding parameters.

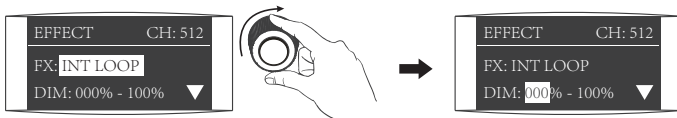

Rotate "Right knob" to select from DIM, SPD and CLR.

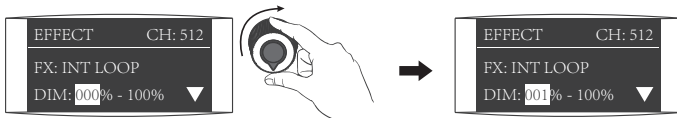

Rotate "Left knob" to set the corresponding parameters.

④CCT FLASH

To set the CCT FLASH, rotate "Right knob" to select from DIM, CCT, G/M and INTVL (range: 0.1S...10.0S), then rotate "Left knob" to set the corresponding parameters.

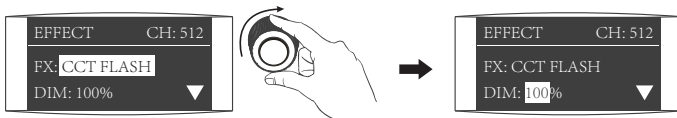

Rotate "Right knob" to select from DIM, CCT, G/M and INTVL.



Rotate "Left knob" to set the corresponding parameters.

⑤ HUE FLASH

To set the HUE FLASH, rotate "Right knob" to select from DIM, HUE, SAT and INTVL (range: 0.1S...10.0S), then rotate "Left knob" to set the corresponding parameters.

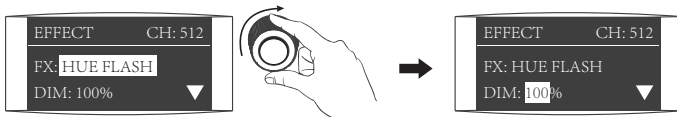

Rotate "Right knob" to select from DIM, HUE, SAT and INTVL.



Rotate "Left knob" to set the corresponding parameters.

⑥ CCT PULSE

To set the CCT PULSE, rotate "Right knob" to select from DIM, CCT, G/M and PULSES/M (range: 001...240), then rotate "Left knob" to set the corresponding parameters.

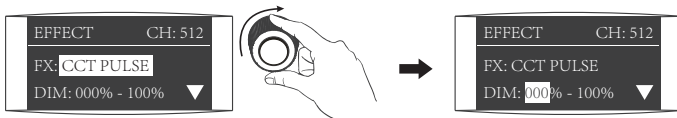

Rotate "Right knob" to select from DIM, CCT, G/M, and PULSES/M.



Rotate "Left knob" to set the corresponding parameters.

⑦ HUE PULSE

To set the HUE PULSE, rotate "Right knob" to select from DIM, HUE, SAT and PULSES/M (range: 001...240), then rotate "Left knob" to set the corresponding parameters.



Rotate "Right knob" to select from DIM, HUE, SAT and PULSES/M.



Rotate "Left knob" to set the corresponding parameters.

⑧STORM

To set the STORM, rotate "Right knob" to select from DIM, CCT and INTVL (range: 01S...60S), then rotate "Left knob" to set the corresponding parameters.

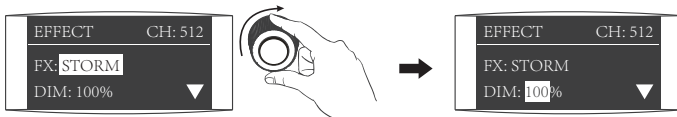

Rotate "Right knob" to select from DIM, CCT and INTVL.



Rotate "Left knob" to set the corresponding parameters.

⑨ POLICE CAR

To set the POLICE CAR, rotate "Right knob" to select from DIM, CLR (B/RB/BW/RBW) and SPD (range: 001...100), then rotate "Left knob" to set the corresponding parameters.



Rotate "Right knob" to select from DIM, CLR and SPD.



Rotate "Left knob" to set the corresponding parameters.

⑩ TV

To set the TV, rotate "Right knob" to select from DIM, CCT, G/M and SPD (range: 001...100), then rotate "Left knob" to set the corresponding parameters.



Rotate "Right knob" to select from DIM, CCT, G/M and SPD.



Rotate "Left knob" to set the corresponding parameters.

⑩PAPARAZZI

To set the PAPARAZZI, rotate "Right knob" to select from DIM, CCT, G/M and SPD (range: 001...100), then rotate "Left knob" to set the corresponding parameters.



Rotate "Right knob" to select from DIM, CCT, G/M and SPD.



Rotate "Left knob" to set the corresponding parameters.

⑫ CANDLE/FIRE

To set the CANDLE/FIRE, rotate "Right knob" to select from DIM, CCT, G/M and SPD (range: 001...100), then rotate "Left knob" to set the corresponding parameters.



Rotate "Right knob" to select from DIM, CCT, G/M and SPD.



Rotate "Left knob" to set the corresponding parameters.

⑬ DISCO

To set the DISCO, rotate "Right knob" to select from DIM, COLOR (3、 6、 9、 12、 15、 18、 21、 24) and SPD (range: 001...100), then rotate "Left knob" to set the corresponding parameters.



Rotate "Right knob" to select from DIM, COLOR and SPD.



Rotate "Left knob" to set the corresponding parameters.

⑭BAD BULB

To set the BAD BULB, rotate "Right knob" to select from DIM, CCT, G/M and SPD (range: 001...100), then rotate "Left knob" to set the corresponding parameters.



Rotate "Right knob" to select from DIM, CCT, G/M and SPD.



Rotate "Left knob" to set the corresponding parameters.

⑮ FIREWORK

To set the FIREWORK, rotate "Right knob" to select from DIM, COLOR (3、 6、 9、 12、 15、 18、 21、 24), SPD (range: 001...100) and DECAY (range: 001...100), then rotate "Left knob" to set the corresponding parameters.



Rotate "Right knob" to select from DIM, COLOR, SPD and DECAY.



Rotate "Left knob" to set the corresponding parameters.

⑯ EXPLOSION

To set the EXPLOSION, rotate "Right knob" to select from DIM, CCT, G/M, SPD (range: 001...100) and DECAY (range: 001...100), then rotate "Left knob" to set the corresponding parameters.



Rotate "Right knob" to select from DIM, CCT, G/M, SPD and DECAY.

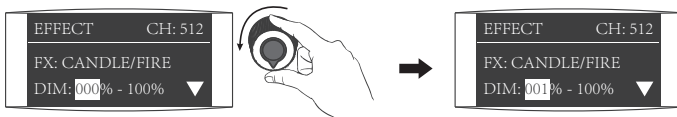

Rotate "Left knob" to set the corresponding parameters.

⑰ WELDING

To set the WELDING, rotate "Right knob" to select from DIM, CCT, G/M, SPD (range: 001...100) and PAUSE (ON/OFF), then rotate "Left knob" to set the corresponding parameters.



Rotate "Right knob" to select from DIM, CCT, G/M, SPD and PAUSE.



Rotate "Left knob" to set the corresponding parameters.

- Special effects may be upgraded based on the firmware update. Please refer to the latest firmware function description for reference.

5.MENU



Press MODE button to menu.



Rotate "Right knob" to select from CH, LANGUAGE, FAN, BLUETOOTH, DMX MODE, DMX REDUCED CH, WIRELESS PROTOCOL, FIRMWARE UPDATE and VERSION.

①For channel setting, please refer to P7 for more operation details.

②LANGUAGE



Rotate "Right knob" to LANGUAGE.



Rotate "Left knob" to select Chinese or English.

③FAN setting

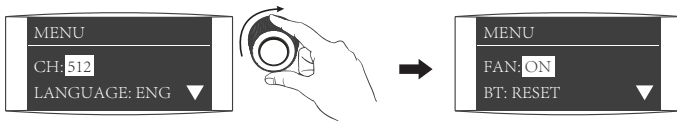

Rotate "Right knob" to FAN.



Rotate "Left knob" to select ON or OFF.

Note: (1) The maximum output is 100% when the fan is turned on.

(2) The maximum output is 25% when the fan is turned off.

④Bluetooth Reset



Rotate "Right knob" to BT.



Rotate "Left knob" to enter the interface of Bluetooth reset.



Rotate "Right knob" to select RESET.



Press MODE button to confirm reset, and it will automatically return to the menu after Bluetooth reset.

- ⑥DMX MODE, please refer to P8 for DMX mode setting.
- ⑥DMX REDUCED CH, please refer to P9 for DMX reduced channel setting.
- ⑦WIRELESS PROTOCOL, please refer to P12 for wireless protocol setting.

⑧ FIRMWARE UPDATE

Insert the USB flash drive with new firmware into the USB port of the fixture.

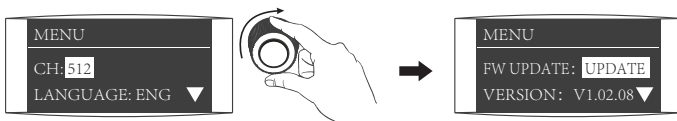

In the menu, rotate "Right knob" to FW UPDATE.



Rotate "Right knob" to enter the interface of firmware update.

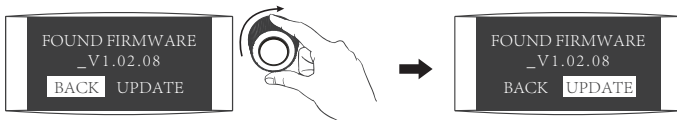

Rotate "Right knob" to select "Update".



Press "Right knob" to confirm the update, and it will prompt "FIRMWARE UPDATED" after the firmware update is completed.

⑨VERSION



Rotate "Right knob" to VERSION to check the current version.

6. Lock or Unlock Settings: long press the "Right knob" to lock the light status. The current light status cannot be changed by pressing the button or rotating the knob. Long press the "Right knob" again to release the lock status.



Long press the "Right knob" to lock.



Long press the "Right knob" again to unlock.

7. When the fixture is not in use, please turn it off.







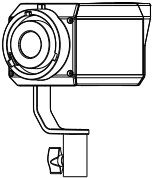

Safety Precautions

1. Please open the package to check for possible damage caused in transit, please do not use if damage is found and contact place of purchase or manufacturer as soon as possible.
2. Do not use a power cord with damaged insulation, do not unplug too hard or drag the power cord directly.
3. Make sure that the power supply voltage used matches the voltage designated by the light before installation.
4. Please turn the light off when it is not in use or before cleaning.
5. Keep the light safely stored and away from children.

Notice

1. Please remove the COB protective cap before using the light.
2. Please do not look directly at the emitter when the light is on .
3. Please wait 10 seconds to turn off the fixture after any parameter setting in order to save it for future use.
4. Please do not place any object on the light emitter or allow liquid to flow inside the fixture or the emitter.
5. Please do not place the fixture near flammable substances like alcohol or gasoline.
6. Please wipe off debris or dirt by using a cloth with clean water or neutral cleanser when cleaning the light.
7. The light should be safely operated where it won't be at risk of getting wet or under extreme temperature. Please make sure the ventilation fan is not blocked or obstructed.
8. Please do not attempt to repair the light fixture by yourself. Attempts to self repair will void warranty. Qualified professionals should make maintenance under the conditions of strictly following the operating procedures described in this manual.
9. Please ensure the vents would not be covered when using, to affect heat dissipation, resulting in the light damaged. When using the light for a long time, the temperature of the light surface will be high, please pay attention to anti-scalding.

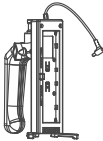
What's in th box? Please kindly check.

| | | | |
|---|---|---|---|
| <p>Forza 60C ×1</p> | <p>Power Adapter ×1</p> | <p>Power Cable 3M ×1</p> | <p>RF-FMM-45-S Reflector ×1</p> |
|  |  |  |  |
| <p>Carrying Bag ×1</p> | <p>AS-CAP-FMM COB Protective Cap ×1</p> | <p>BH-FZ60 Battery Grip ×1</p> | <p>AS-BA-FMM Bowens mount adapter ×1</p> |
|  |  |  |  |
| <p>User Manual × 1</p> | | | |
|  | | | |

General Fault Detection and Diagnosis

| Fault Detection | Diagnosis |
|---|---|
| The light won't boot up properly | <ol style="list-style-type: none"> 1. Please check whether the power supply, cable and outlet are properly connected and that the cable is not faulty or loose. 2. Please check whether the voltage value is within the specified parameters. 3. If the fixture is powered by batteries, please check if the batteries are into place, whether the battery voltage/current is consistent with the specified voltage/current. |
| The fixture can be operated manually, but DMX control is not working. | <ol style="list-style-type: none"> 1. Please check whether the DMX address code setting of the fixture is correct. 2. Please check that the XLR signal cable is connected correctly and that it is not faulty or damaged. |
| LCD display is on, but light cannot be operated. | The COB or main board damaged. |
| The fan doesn't work | Please check if the fan is set to OFF mode. |
| If the failure is not resolved after troubleshooting, please contact place of purchase. | |

This manual and all stats within it were produced under controlled conditions, and are accurate at time of print. Any future changes to design/technical data can be found at www.nanlite.com.

Version: V1 2022-04-09

NANLITE

 +86-754-85751187

 +86-754-85300887

 service@nanlite.com

 Zhanglin,324,Dongli Chenghai Shantou Guangdong China

www.nanlite.com