

EVO

SERIES USER MANUAL

December 2020. Firmware V01.04



made to last

This guide provides information about how to use the product functions to illuminate with this equipment as well as warnings on his use.

These are products of professional use for exterior and interior locations or studio and must be operated only by qualified technical personnel.

To obtain the maximum features, please read the following operating instructions very carefully before using this fixture for the first time. Please keep these operating instructions for you and subsequent users to reference in the future.

THELIGHT Luminary for cine and TV, S.L.

Every EVO color tunable LED panel is offered in two different version: Weatherproof and STUDIO dustproof. The main differences are:

The **WEATHERPROOF** version includes

- Weatherproof protection IP54
- Can be powered both AC 90-264V AC and DC 18-35V DC
- 1x XLR-5 IN connector for DMX-RDM wire control
- Includes Wi-Fi Art-Net wireless remote control
- Includes built-in LumenRadio for DMX-RDM wireless control

The **STUDIO** version includes:

- Dustproof protection IP51
- Must be exclusively powered on AC (90-264V AC)
- 2x XLR5 connectors (In and Through) for DMX-RDM wire control
- Includes Wi-Fi Art-Net wireless remote control
- Includes 1x RJ45 connector for Ethernet wire control

The symbols and their meanings are explained below.



WARNING

Possible risk of injury or damage to equipment



DANGER

Indicates the risk of electric shock or fire danger that could result in injury or damage to equipment.

In order to protect against risk of electric shock, the installation should be properly grounded. Defeating the purpose of the grounding type plug will expose you to the risk of electric shock.



Do not open the product. The housing is sealed with several watertight gaskets that will get immediately damaged when trying to open the housing. Doing so will invalidate the IP54 rate and therefore the product warranty.

Do not attempt to repair any part of the product on your own. Maintenance and repair work to be carried out only by VELVET Service Centre.

Do not cover the aluminum lamp head heat sink while using it. Proper ventilation must be provided. Avoid exposing the lamp head to the heat radiation of other light fixtures.

Do not power on the product if the ambient temperature exceeds 45° C.

Never point a light beam from another fixture into the light EVO source.
Do not place the product on heat sources.

Never connect the product to a dimmer system or a dimmer channel in non-dim mode. Doing so will damage the EVO fixture electronics. Damages caused by connecting the product to a not suitable power source are not covered by the warranty.



The lamp head is equipped with power LED. Due to their high light-output intensity don't stare directly into the light source.

Though the light generated by LED does not produce any heat, for what his use turns out to be very comfortable for the actors, the lamp head acts as a heat sink through its back part.

Surface can reach a temperature between the 20 °C and the 70 °C. Please use protective gloves if you touch the lamp head at the heat sink.

VELVET (THELIGHT Luminary for cinema and TV, S.L.) does not assume any responsibility for lighting failures caused by malfunction of this product. The manufacturer disclaims liability for any damage to persons or property caused by inappropriate operation, damage of this kind lies in the responsibility of the operator.

WARRANTY

This product is manufactured to local specifications and the warranty is valid within the country of purchase. Should the product fail or malfunction while you are abroad, the manufacturer assumes no responsibility for servicing the product locally or bearing the expenditure incurred thereof. Various symbols are used throughout this instruction manual and on the product to prevent physical harm to you or other people and damage to property.



This equipment has been checked and meets the requirements of general safety for electronic devices. These requirements are specified to provide a reasonable protection against electromagnetic interferences when the equipment is used in commercial environments.

This equipment generates, uses and can emit waves of radio frequency, and if not properly used following the instructions of this manual can produce interferences in radio communications. The use of this equipment in residential areas can produce interference, the user will be the only responsible of correcting them.

www.velvetlight.tv

The total or partial reproduction of this guide is prohibited without the express written permission of VELVET.

VELVETLight technology is protected under Spanish license laws with international patents pending.

Information and specifications in this document are subject to change without notice.

- 02 INTRODUCTION
- 03 SAFETY PRECAUTIONS
- 04 EXEMPTION from LIABILITY, WARRANTY
- 06 MAIN FEATURES
- 07 FIRMWARE NEW FEATURES
- 08 QR FAST ACCESS
- 09 RANGE MODELS
 - 09 EVO 1 WEATHERPROOF
 - 11 EVO 1 STUDIO
 - 13 EVO 2 WEATHERPROOF
 - 15 EVO 2 STUDIO
 - 17 EVO 2x2 WEATHERPROOF
 - 19 EVO 2x2 STUDIO
- 22 ACCESSORIES
 - 22 POWER
 - 25 RIGGING
 - 26 BEAM CONTROL
 - 28 REMOTE CONTROL
 - 29 TRANSPORT and PROTECT
- 30 INSTALLATION
 - 30 YOKE to PANEL Assembly
 - 32 POLE OPERATED YOKE to PANEL Assembly
 - 34 MOUNTING and SECURITY
 - 35 BEAM SHAPING ACCESSORIES
- 38 POWER OPTIONS STUDIO IP51 MODELS
- 39 POWER OPTIONS WEATHERPROOF IP54 MODELS
- 43 EVO MENU OPERATION
 - 43 FIXTURE BUTTON OVERVIEW
 - 44 DISPLAY STRUCTURE
 - 45 FIXTURE MAIN MENU STRUCTURE
- 46 EVO CONTROL COLOR MODES
 - 46 OPTIONS and MODES
 - 47 COLOR MODES/ CCT, HSI+ and GEL MODE
 - 48 RGB+ MODE and EFFECTS
 - 49 EFFECTS LIST
- 50 EVO CONTROL SETTINGS MENU
 - 50 DIMMING CURVES
 - 51 WIRE OPTIONS/ DMX-RDM CONTROL
 - 52 DMX 8 BIT MAP CHART
 - 53 DMX 16 BITS MAP CHART
 - 54 GELS LIST
 - 55 EFFECTS and LIGHTSOURCES LISTS
 - 56 WIRE and WIRELESS: ETHERNET ArtNet
 - 57 WIRELESS: LumenRadio
 - 59 WIRELESS: WI-FI Art-Net
 - 61 VELVET GOYA APP
 - 63 DISPLAY and ABOUT: FACTORY PRESET and FIRMWARE UPDATE
- 65 DIAGRAMS
- 71 REGULATIONS
- 72 WARRANTY

Thank you for selecting EVO LED panel from VELVET. The EVO is a compact, portable, silent, maintenance-free and high-quality color tunable LED soft light. It is much more efficient than a traditional soft light and is the LED soft light efficiency market leader with 4.1 Lux per watt.

The EVO panels emit variable colored light with adjustable color temperature and adjustable green/magenta correction. Every EVO model can be controlled using DMX-RDM protocol, Art-Net through LumenRadio wireless, Wi-fi Art-Net or locally with shock-resistant buttons and color display.

RICH COLORS

EVO full color spectrum light is produced by the exclusive technology developed by VELVET for professional photography, cinematography and television industry use. It brings the most advanced color technology in an LED lighting panel.

5LED FULL COLOR SPECTRUM LIGHT

The combination of 5 LED (R+G+B+W+CW) extend the color possibilities over traditional RGBW technology, producing a much wider color gamut, a more natural white light and richer, saturated colors. The EVO 5LED technology offers higher degree of color control:

- Any base white light color temp. can be set to apply any color or gel.
- Settings on one mode can be fine-tuned in any other.

SILENT and COOL LIGHT

The EVO runs completely silently, with no fans to service, it does not emit any infrared or UV radiation therefore does not forward heat, making actors feel comfortable into its light beam.

The VELVET EVO leads the industry in electronic and optic efficiency. This has real on-set advantages, and a whole cascade of benefits:

- More running time off standard 14.4V Vlock or Gold Mount batteries
- 100% fan-free and silent operation (no maintenance required)
- Full output from both AC and DC power

TOTAL CONTROL

EVO can be fully, quickly and easily controlled in any possible way, locally or wirelessly, or from your smartphone with VELVET App.

WIRELESS

- DMX-RDM through LumenRadio CRMX only EVO Weatherproof version
- Wi-Fi Art-Net to control from Smart device VELVET App

WIRE CONTROL

- DMX-RDM through XLR-5 connector
- Art-Net through Ethernet RJ-45 connector (only STUDIO version).

LOCAL CONTROL

The color display offers unlimited possibilities, quick user-friendly control and shock-proof buttons.

- Gels list are displayed as colors
- White light or color adjustment preset is always visible on its real color.

SUPERSOFT

The EVO produces a super soft uniform, single-shadow, natural light at any white light or color setting. The fully tunable white and color light emitted by EVO produce a beautiful wraparound true-to-life light quality.

V01.03

FIRMWARE NEW FEATURES

- New DMX mode RGB+ 8bits/ 16bits

V01.02

FIRMWARE NEW FEATURES

- Large display fonts and color graphics
- Independent CTT mode
- Control menu lock
- Display brightness
- Extended effects parameters
- Dimming curves
- On DMX-RDM:
 - Eight new DMX modes
 - Changing mode
 - Master/Slave mode
 - DMX signal detected color warning
- LumenRadio information
- Wi-fi remote control
- Ethernet wire control on EVO STUDIO
- USB presets



EVO UPDATED SERVICE MANUAL PDF



EVO BROCHURE PDF

EVO SERIES FIRMWARE DOWNLOAD LINK

<https://www.velvetlight.tv/velvet-evo/>

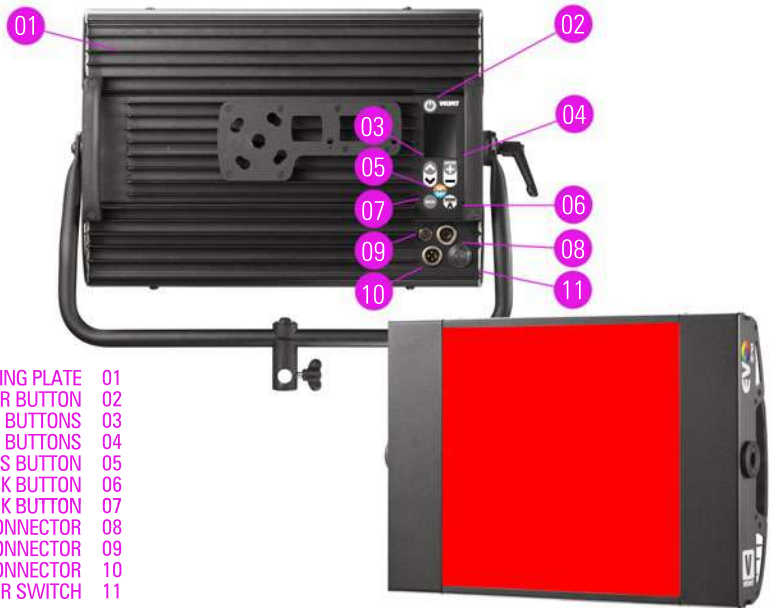

- ACCESSORIES MOUNTING PLATE 01
- LIGHT POWER BUTTON 02
- UP AND DOWN SCROLL BUTTONS 03
- ENTER/+ & - ADJUSTMENT BUTTONS 04
- 3200K / 5600K QUICK ACCESS BUTTON 05
- MODE SELECTION/ LOCK BUTTON 06
- BACK BUTTON 07
- XLR-5 DMX RDM IN/OUT CONNECTOR 08
- MICRO USB CONNECTOR 09
- XLR-3 DC IN CONNECTOR 10
- MAIN POWER SWITCH 11

- BEAM ANGLE** 115°
- COLOUR TEMPERATURE** Continuously adjustable from 2.500K to 10.000K
- LIGHT INTENSITY** Dimmable 0 to 100, smooth and flicker-free
- GREEN-MAGENTA** Continuously adjustable (full Plusgreen to full Minusgreen)

- COLOR** Full color spectrum R+G+B+W+CW with Hue, Saturation and base Color temperature control

- COLOR CONTROL MODES** CTT mode, HSI+ mode, GEL mode, RGB+ mode, EFFECTS mode
NOTE: base Kelvin light can be set combined with any color

- CONTROL**
 - LOCAL CONTROL with shock proof buttons and color display
 - WIRE CONTROL DMX-RDM with XLR-5 IN connector
 - WIRELESS CONTROL DMX-RDM with LumenRadio CRMX, Wi-Fi Art-Net + Android and IOS VELVET App

- TCCOLOR RENDERING INDEX** Exceeds 95 CRI
- TLCI** Exceeds 95 TLCI
- PHOTOMETRICS** 3500 Lux at 1 m/ 325 fc at 3 feet
450 Lux at 3 m/ 41 fc at 10 feet

- DIMENSIONS** 453 x 318 x 92mm / 17.8 x 12.5 x 3.6 inches
- PANEL WEIGHT** 4.4 kg / 9.7 lbs
- PANEL + YOKE WEIGHT** 4.9 kg / 10.8 lbs
- POWER** 100W (0.9 Amps at 110 VAC)
- POWER SUPPLY** 12-35V DC via XLR3. V-Lock or Gold mount battery plate 90-264V AC 50/60Hz
- LED RATED LIFE** Exceeds 50,000 hours
- COOLING** Silent and fan-free passive cooling
- PROTECTION** IP54 rainproof and dustproof, indoor or outdoor use
- CONSTRUCTION & FINISH** Fixture and yoke made of black powdercoated extruded and sheet aluminum
- RIGGING OPTIONS** aluminum yoke with 16mm baby receptacle combined with 28mm junior pin, center ball-head mount, multiple 1/4"-20 rigging points, double vertical yoke, pole operated yoke

Ref. VE1CIP54
INCLUDES

1x EVO 1 Color tunable LED panel IP54 with DC in XLR-3, 1x DMX in XLR-5, 1x Micro-USB, LumenRadio wireless DMX-RDM, Wi-fi Art-Net, 1x yoke with 28mm junior pin - 16mm baby receiver

Ref. VE1CIP54NY
INCLUDES

1x EVO 1 Color tunable LED panel IP54 with DC in XLR-3, 1x DMX in XLR-5, 1x Micro-USB, LumenRadio wireless DMX-RDM, Wi-fi Art-Net

The EVO 1 is a 1x1 feet (30x30 cm) weatherproof panel made of 100% aluminum, designed specifically to endure the toughest working conditions in wet or dusty locations. EVO 1 delivers full power light around one hour using a single 90Wh 14.4V battery. EVO's back panel has a twist-on plate to quickly install the battery mount, AC Power supply, or center-rig ball joint mount. The EVO 1 weights only 4.4 kgs / 9.7 lbs. and it is just 92mm / 3.6" thick.

RELATIVE VALUE

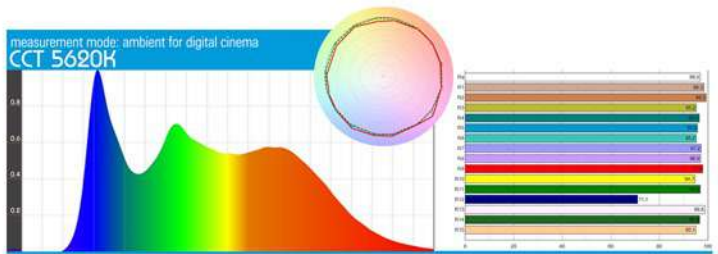

RELATIVE VALUE

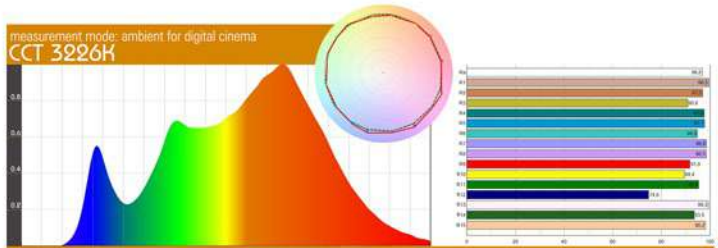

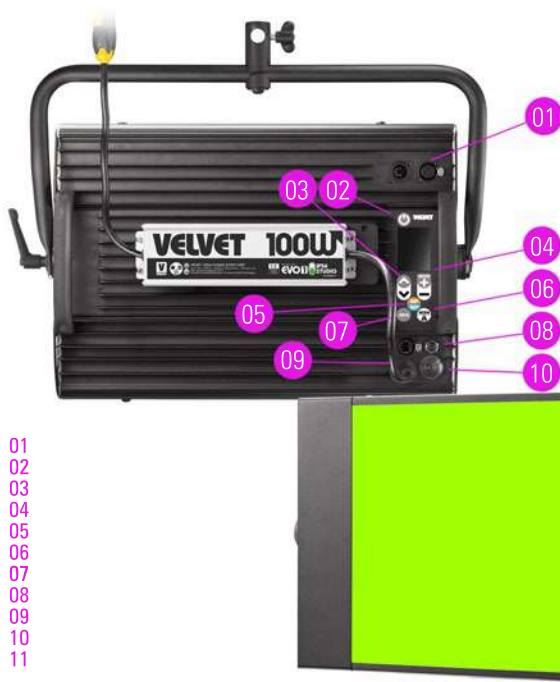

- XLR-5 DMX RDM IN + OUT CONNECTOR 01
- LIGHT POWER BUTTON 02
- UP AND DOWN SCROLL BUTTONS 03
- ENTER/+ & - ADJUSTMENT BUTTONS 04
- 3200K / 5600K QUICK ACCESS BUTTON 05
- MODE SELECTION/ LOCK BUTTON 06
- BACK BUTTON 07
- MICRO USB CONNECTOR 08
- RJ-45 ETHERCON LAN CONNECTOR 09
- MAIN POWER SWITCH 10
- XLR-3 DC IN CONNECTOR 11

- BEAM ANGLE** 115°
- COLOUR TEMPERATURE** Continuously adjustable from 2.500K a 10.000K
- LIGHT INTENSITY** Dimmable 0 to 100, smooth and flicker-free
- GREEN-MAGENTA** Continuously adjustable (full Plusgreen to full Minusgreen)
- COLOR** Full color spectrum R+G+B+W+CW with Hue, Saturation and base Color temperature control
- COLOR CONTROL MODES** CTT mode, HSI+ mode, GEL mode, RGB+ mode, EFFECTS mode
NOTE: base Kelvin light can be set combined with any color
- CONTROL**
 - LOCAL CONTROL with shock proof buttons and color display
 - WIRE CONTROL DMX-RDM with XLR-5 IN & THROUGH connector, Ethernet Art-Net with RJ-45 connector
 - WIRELESS Wi-Fi Art-Net + Android and IOS VELVET App
- COLOR RENDERING INDEX** Exceeds 95 CRI
- TLCI** Exceeds 95 TLCI
- PHOTOMETRICS** 3500 Lux at 1 m/ 325 fc at 3 feet
450 Lux at 3 m/ 41 fc at 10 feet
- DIMENSIONS** 453 x 318 x 113mm / 12.5 x 12.5 x 4.4 inches
- PANEL WEIGHT** 5.6 kg / 12.3 lb
- PANEL + YOKE WEIGHT** 6.1 kg / 14.4 lb
- POWER** 100W (0.9 Amps at 110 VAC)
- AC INPUT VOLTAGE** 90-264 VAC 50/60Hz
- LED RATED LIFE** Exceeds 50,000 hours
- COOLING** Silent and fan-free passive cooling
- PROTECTION** IP54 rain and dustproof, indoor or outdoor use
- CONSTRUCTION & FINISH** Fixture and yoke made of black powdercoated extruded and sheet aluminum
- RIGGING OPTIONS** aluminum yoke with 28mm junior pin (optionally with the 16mm baby receptacle), center ball-head mount, multiple ¼"-20 rigging points, double vertical yoke, pole operated yoke

**Ref. VE1CST
INCLUDES**

1x EVO 1 Color tunable Studio LED panel IP51 with DC in XLR-3, integrated AC power supply, DMX in&out XLR-5, Mini-USB, WIFI Art-Net, 1x RJ45 Ethernet, 1x yoke with Euro28mm junior pin - 16mm baby receiver, 1x PowerCon TRUE1 power cable.

**Ref. VE1CSTNY
INCLUDES**

1x EVO 1 Color tunable Studio LED panel IP51 with DC in XLR-3, integrated AC power supply, DMX in&out XLR-5, Mini-USB, WIFI Art-Net, 1x RJ45 Ethernet, 1x PowerCon TRUE1 power cable.

The EVO 1 STUDIO is a 1x1 feet (30x30 cm) dustproof, maintenance-free panel, which runs completely silently, with no fans to service.
 The STUDIO version operates exclusively on AC power and includes input and through DMX XLR-5 connectors for daisy-chaining. It also includes an Ethernet RJ-45 connector.
 EVO 1 STUDIO is ideal for studio applications. Its low weight, slim profile and industry leader efficiency with only 100W consumption speed up installation.
 The EVO 1 STUDIO weights only 5.6 kgs / 12.3 lbs. including yoke and it is just 128mm / 5" thick.

RELATIVE VALUE

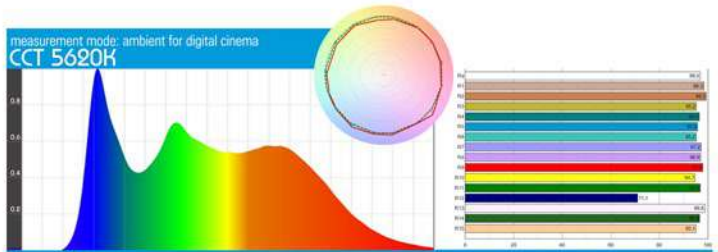

RELATIVE VALUE

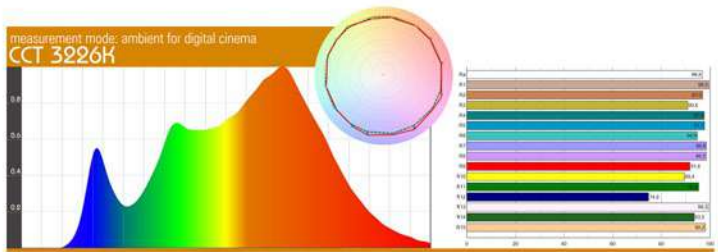



- ACCESSORIES MOUNTING PLATE 01
- LIGHT POWER BUTTON 02
- UP AND DOWN SCROLL BUTTONS 03
- ENTER/+ & - ADJUSTMENT BUTTONS 04
- 3200K / 5600K QUICK ACCESS BUTTON 05
- MODE SELECTION/ LOCK BUTTON 06
- BACK BUTTON 07
- XLR-5 DMX RDM IN/OUT CONNECTOR 08
- MICRO USB CONNECTOR 09
- XLR-3 DC IN CONNECTOR 10
- MAIN POWER SWITCH 11

- BEAM ANGLE** 115°
- COLOUR TEMPERATURE** Continuously adjustable from 2.500K to 10.000K
- LIGHT INTENSITY** Dimmable 0 to 100, smooth and flicker-free
- GREEN-MAGENTA** Continuously adjustable (full Plusgreen to full Minusgreen)

- COLOR** Full color spectrum R+G+B+W+CW with Hue, Saturation and base Color temperature control

- COLOR CONTROL MODES** CTT mode, HSI+ mode, GEL mode, RGB+ mode, EFFECTS mode
NOTE: base Kelvin light can be set combined with any color

- CONTROL**
 - LOCAL CONTROL with shock proof buttons and color display
 - WIRE CONTROL DMX-RDM with XLR-5 IN connector
 - WIRELESS CONTROL DMX-RDM with LumenRadio CRMX, Wi-Fi Art-Net + Android and IOS VELVET App

- COLOR RENDERING INDEX** Exceeds 95 CRI
- TLCI** Exceeds 95 TLCI
- PHOTOMETRICS** 7000 Lux at 1 m/ 650 fc at 3 feet
900 Lux at 3 m/ 83 fc at 10 feet

- DIMENSIONS** 753 x 318 x 93mm / 29.6 x 12.5 x 3.6 inches
- PANEL WEIGHT** 6.9 kg / 15.2 lb
- PANEL + YOKE WEIGHT** 7.6 kg / 16.7 lb
- POWER** 200W (1.8 Amps at 110 VAC)
- POWER SUPPLY** 24-35V DC via XLR3. V-Lock or Gold mount battery plate 90-264V AC 50/60Hz
- LED RATED LIFE** Exceeds 50,000 hours
- COOLING** Silent and fan-free passive cooling
- PROTECTION** IP54 rainproof and dustproof, indoor or outdoor use
- CONSTRUCTION & FINISH** Fixture and yoke made of black powdercoated extruded and sheet aluminum
- RIGGING OPTIONS** aluminum yoke with 16mm baby receptacle combined with 28mm junior pin, center ball-head mount, multiple ¼"-20 rigging points, double vertical yoke, pole operated yoke

Ref. VE2CIP54 INCLUDES 1x EVO 2 Color LED panel IP54 with DC in XLR-3, 1x DMX in XLR-5, 1x Micro-USB, LumenRadio wireless DMX, VELVET WIFI, 1x yoke with 28mm junior pin - 16mm baby receiver, 1x hexagonal baby mount

Ref. VE2CIP54NY INCLUDES Panel without yoke 1x EVO 2 Color LED panel IP54 with DC in XLR-3, 1x DMX in XLR-5, 1x Micro-USB, LumenRadio wireless DMX, VELVET WIFI, 1x hexagonal baby mount

EVO 2 is a weatherproof panel with a 100% aluminum housing, designed specifically to endure the toughest working conditions in wet or dusty locations. It delivers the same full output powered by two standard V-Lock or Gold Mount batteries as it does from AC power. EVO's back panel has a twist-on plate to quickly install the battery mount, AC Power supply, or center-rig ball joint mount. The EVO 2 weighs only 6.9 kgs / 15.2 lbs and it is just 92mm / 3.6" thick.

RELATIVE VALUE

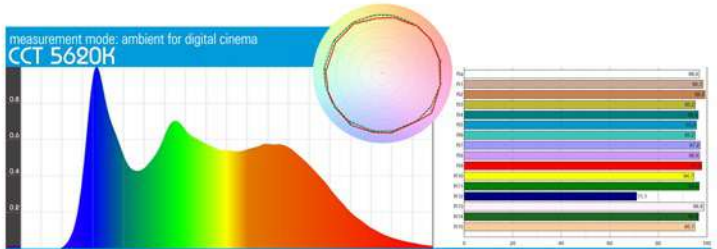

RELATIVE VALUE

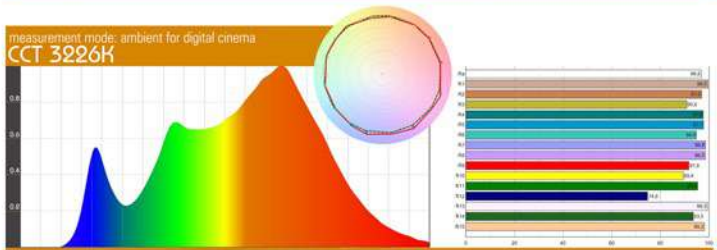

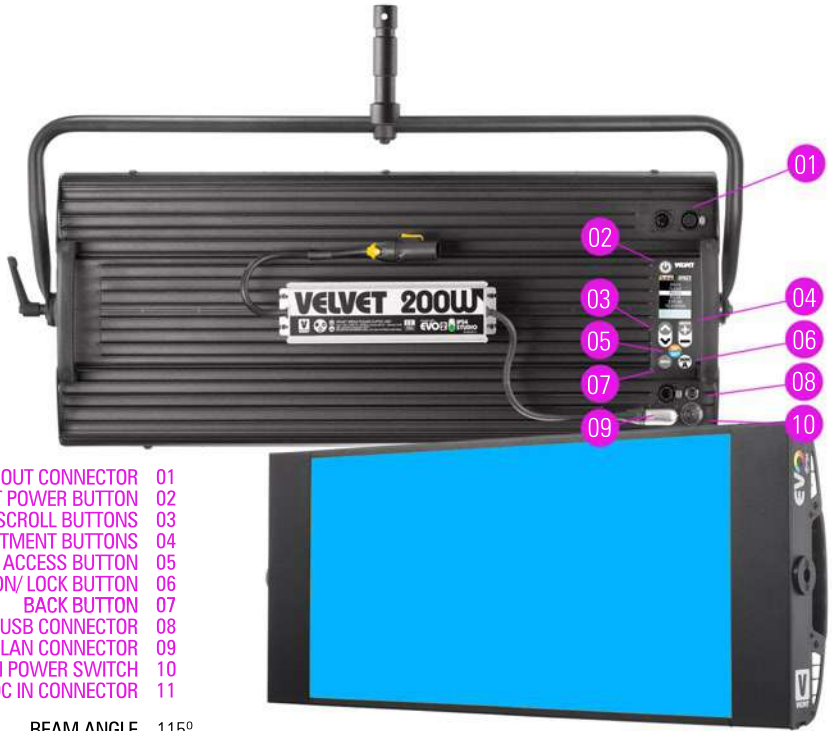

- XLR-5 DMX RDM IN + OUT CONNECTOR 01
- LIGHT POWER BUTTON 02
- UP AND DOWN SCROLL BUTTONS 03
- ENTER/+ & - ADJUSTMENT BUTTONS 04
- 3200K / 5600K QUICK ACCESS BUTTON 05
- MODE SELECTION/ LOCK BUTTON 06
- BACK BUTTON 07
- MICRO USB CONNECTOR 08
- RJ-45 ETHERCON LAN CONNECTOR 09
- MAIN POWER SWITCH 10
- XLR-3 DC IN CONNECTOR 11

<p>BEAM ANGLE 115°</p> <p>COLOUR TEMPERATURE Continuously adjustable from 2.500K a 10.000K</p> <p>LIGHT INTENSITY Dimmable 0 to 100, smooth and flicker-free</p> <p>GREEN-MAGENTA Continuously adjustable (full Plusgreen to full Minusgreen)</p>	<p>COLOR Full color spectrum R+G+B+W+CW with Hue, Saturation and base Color temperature control</p>
<p>COLOR CONTROL MODES CTT mode, HSI+ mode, GEL mode, RGB+ mode, EFFECTS mode</p> <p>NOTE: base Kelvin light can be set combined with any color</p>	<p>CONTROL</p> <ul style="list-style-type: none"> ● LOCAL CONTROL with shock proof buttons and color display ● WIRE CONTROL DMX-RDM with XLR-5 IN & THROUGH connector, Ethernet Art-Net with RJ-45 connector ● WIRELESS Wi-Fi Art-Net + Android and IOS VELVET GOYA App
<p>COLOR RENDERING INDEX Exceeds 95 CRI</p> <p>TLCI Exceeds 95 TLCI</p> <p>PHOTOMETRICS 7000 Lux at 1 m/ 650 fc at 3 feet 900 Lux at 3 m/ 83 fc at 10 feet</p>	<p>DIMENSIONS 753 x 318 x 113mm / 29.6 x 12.5 x 4.4 inches</p> <p>PANEL WEIGHT 8.2 kg / 16 lb</p> <p>PANEL + YOKE WEIGHT 8.9 kg / 19.6 lb</p> <p>POWER 200W (1.8 Amps at 110 VAC)</p> <p>AC INPUT VOLTAGE 90-264 VAC 50/60Hz</p> <p>LED RATED LIFE Exceeds 50,000 hours</p> <p>COOLING Silent and fan-free passive cooling</p> <p>PROTECTION IP54-rain and dustproof, indoor or outdoor use</p> <p>CONSTRUCTION & FINISH Fixture and yoke made of black powdercoated extruded and sheet aluminum</p> <p>RIGGING OPTIONS aluminum yoke with 28mm junior pin (optionally with the 16mm baby receptacle), center ball-head mount, multiple ¼"-20 rigging points, double vertical yoke, pole operated yoke</p>

Ref. VE2CST INCLUDES 1x EVO 2 Color tunable Studio LED panel IP51 with DC in XLR-3, integrated AC power supply, DMX in & out XLR-5, Mini-USB, WIFI Art-Net, 1x RJ45 Ethernet, 1x yoke with Euro 28mm junior pin - 16mm baby receiver, 1x PowerCon TRUE1 power cable.

Ref. VE2CSTNY INCLUDES 1x EVO 2 Color tunable Studio LED panel IP51 with DC in XLR-3, integrated AC power supply, DMX in & out XLR-5, Mini-USB, WIFI Art-Net, 1x RJ45 Ethernet, 1x PowerCon TRUE1 power cable.

The EVO 2 STUDIO is a dustproof, maintenance-free panel, which runs completely silently, with no fans to service. The STUDIO version operates exclusively on AC power and includes input and through DMX XLR5 connectors for daisy-chaining. It also includes an Ethernet connection through RJ45.

EVO is ideal for studio applications. Its low weight, slim profile and industry leader efficiency with only 200W consumption speed up installation. The EVO 2 Studio weights only 8.9 kgs / 19.6 lbs. Including yoke and it is just 128mm / 5" thick.

RELATIVE VALUE

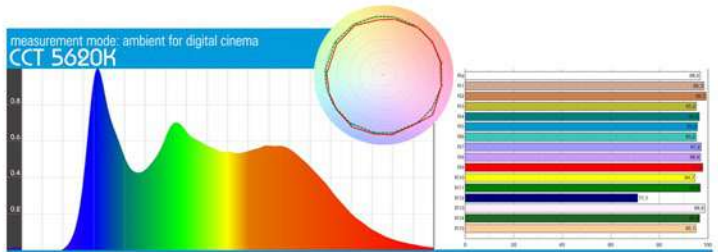

RELATIVE VALUE

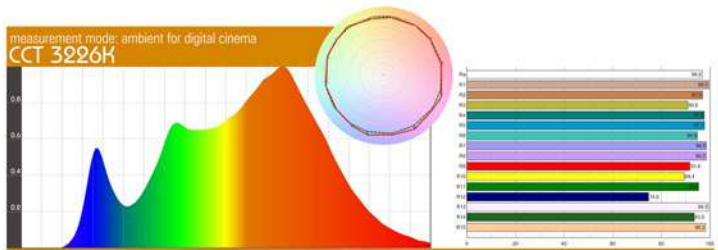



- ACCESSORIES MOUNTING PLATE 01
- XLR-5 DMX RDM IN/OUT CONNECTOR 02
- MICRO USB CONNECTOR 03
- LIGHT POWER BUTTON 04
- UP AND DOWN SCROLL BUTTONS 05
- ENTER/+ & - ADJUSTMENT BUTTONS 06
- 3200K / 5600K QUICK ACCESS BUTTON 07
- MODE SELECTION/ LOCK BUTTON 08
- BACK BUTTON 09
- XLR-3 DC IN CONNECTOR 10
- MAIN POWER SWITCH 11



BEAM ANGLE	115°
COLOUR TEMPERATURE	Continuously adjustable from 2.500K to 10.000K
LIGHT INTENSITY	Dimmable 0 to 100, smooth and flicker-free
GREEN-MAGENTA	Continuously adjustable (full Plusgreen to full Minusgreen)
COLOR	Full color spectrum R+G+B+W+CW with Hue, Saturation and base Color temperature control
COLOR CONTROL MODES	CCT, HSI+, GEL, RGB+W+CW and EFFECTS modes NOTE: base Kelvin light can be set combined with any color
CONTROL	<ul style="list-style-type: none"> ● LOCAL CONTROL with shock proof buttons and color display ● WIRE CONTROL DMX-RDM with XLR-5 IN connector ● WIRELESS CONTROL DMX-RDM with LumenRadio CRMX Wi-Fi Art-Net, Bluetooth + Android and IOS Goya App
COLOR RENDERING INDEX	Exceeds 95 CRI
TLCI	Exceeds 95 TLCI
PHOTOMETRICS	13000 Lux at 1 m/ 1800 fc at 3 feet 1200 Lux at 3 m/ 166 fc at 10 feet
DIMENSIONS	763 x 620 x 93mm / 30 x 24.4 x 3.6 inches
PANEL WEIGHT	13 kg / 28.6 lb
PANEL + YOKE WEIGHT	15.3 kg / 33.7 lb
POWER	400W (3.6 Amps at 110 VAC)
POWER SUPPLY	28V DC via XLR3. 90-264V AC 50/60Hz
LED RATED LIFE	Exceeds 50,000 hours
COOLING	Silent and fan-free passive cooling
PROTECTION	IP54 rainproof and dustproof, indoor or outdoor use
CONSTRUCTION & FINISH	Fixture and yoke made of black powdercoated extruded and sheet aluminum
RIGGING OPTIONS	Aluminum yoke with 16mm baby receptacle combined with 28mm junior pin, center ball-head mount, multiple 1/4"- 20 rigging points, double vertical yoke, pole operated yoke.

Ref. VE2X2CIP54 INCLUDES 1x EVO 2x2 Color LED panel IP54 with DC in XLR-3, 1x DMX in XLR-5, 1x Micro-USB, LumenRadio wireless DMX, VELVET WIFI, 1x yoke with 28mm junior pin

Ref. VE2X2CIP54NY INCLUDES Panel without yoke 1x EVO 2x2 Color LED panel IP54 with DC in XLR-3, 1x DMX in XLR-5, 1x Micro-USB, LumenRadio wireless DMX, VELVET WIFI

EVO 2x2 is a weatherproof color panel with a 100% aluminum housing, designed specifically to endure the toughest working conditions in wet or dusty locations. It delivers the same full output powered by a 28V battery as it does from AC power and includes built-in wireless DMX LumenRadio, Art-Net Wi-Fi and Bluetooth to remotely control through VELVET GOYA free App.

Unparalleled EVO color light quality emitted from an exclusive and portable 2x2 aperture.



- RJ-45 ETHERCON LAN CONNECTOR 01
- XLR-5 DMX RDM IN + OUT CONNECTOR 02
- LIGHT POWER BUTTON 03
- UP AND DOWN SCROLL BUTTONS 04
- ENTER/+ & - ADJUSTMENT BUTTONS 05
- 3200K / 5600K QUICK ACCESS BUTTON 06
- MODE SELECTION/ LOCK BUTTON 07
- BACK BUTTON 08
- MICRO USB CONNECTOR 09
- MAIN POWER SWITCH 10
- XLR-3 DC IN CONNECTOR 11

BEAM ANGLE	115°
COLOUR TEMPERATURE	Continuously adjustable from 2.500K to 10.000K
LIGHT INTENSITY	Dimmable 0 to 100, smooth and flicker-free
GREEN-MAGENTA	Continuously adjustable (full Plusgreen to full Minusgreen)
COLOR	Full color spectrum R+G+B+W+CW with Hue, Saturation and base Color temperature control
COLOR CONTROL MODES	CCT, HSI+, GEL, RGB+W+CW and EFFECTS modes NOTE: base Kelvin light can be set combined with any color
CONTROL	<ul style="list-style-type: none"> ● LOCAL CONTROL with shock proof buttons and color display ● WIRE CONTROL DMX-RDM XLR-5 IN/THROUGH connectors. Ethernet Art-Net with RJ-45 connector ● WIRELESS CONTROL Wi-Fi Art-Net, Bluetooth + Android and IOS Goya App
COLOR RENDERING INDEX	Exceeds 95 CRI
TLCI	Exceeds 95 TLCI
PHOTOMETRICS	13000 Lux at 1 m/ 1800 fc at 3 feet 1200 Lux at 3 m/ 166 fc at 10 feet
DIMENSIONS	763 x 620 x 113mm / 30 x 24.4 x 4.4 inches
PANEL WEIGHT	16 kg / 35.2 lb
PANEL + YOKE WEIGHT	18.3 kg / 40.3 lb
POWER	400W (3.6 Amps at 110 VAC)
POWER SUPPLY	90-264V AC 50/60Hz
LED RATED LIFE	Exceeds 50,000 hours
COOLING	Silent and fan-free passive cooling
PROTECTION	IP54 rainproof and dustproof, indoor or outdoor use
CONSTRUCTION & FINISH	Fixture and yoke made of black powdercoated extruded and sheet aluminum
RIGGING OPTIONS	Aluminum yoke with junior pin, multiple ¼"-20 rigging points, double vertical yoke, pole-operated yoke

Ref. VE2X2CST INCLUDES 1x EVO 2x2 Color Studio LED panel IP51 with DC in XLR-3, integrated AC power supply, DMX in&out XLR-5, Mini-USB, VELVET WIFI Art-Net, 1x RJ45 Ethernet, 1x yoke with Euro28mm junior pin, 1x PowerCon TRUE1 power cable

Ref. VE2X2CSTNY INCLUDES 1x EVO 2x2 Color Studio LED panel IP51 with DC in XLR-3, integrated AC power supply, DMX in&out XLR-5, Mini-USB, VELVET WIFI ArtNet, 1x RJ45 Ethernet, 1x PowerCon TRUE1 power cable

EVO 2x2 Studio is a dustproof, maintenance-free color panel, which runs completely silent, with no fans to service. It operates exclusively on AC power and includes in and through DMX XLR5 connectors for daisy chaining and Ethernet control through RJ-45. The built-in Art-Net Wi-Fi and Bluetooth allow advanced remote control through VELVET GOYA free App.

Unparalleled EVO color light quality emitted from an exclusive 2x2 aperture.

RELATIVE VALUE

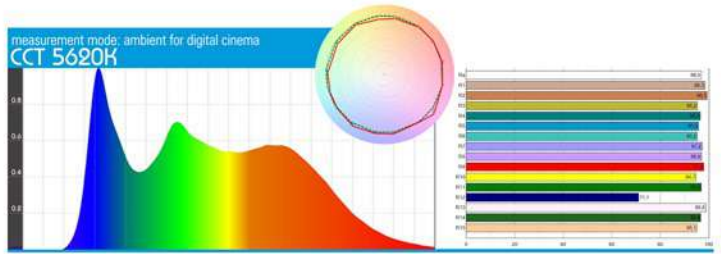

RELATIVE VALUE

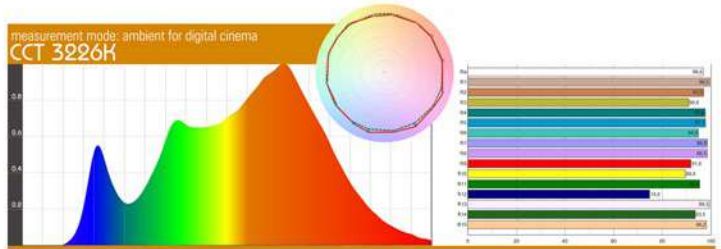



100W AC POWER SUPPLY WEATHERPROOF

with XLR3 IP65 and PowerCon TRUE1 aerial connectors on quick link mount + Schuko Power cable for EVO 1 IP54

NOTE: this AC power supply can exclusively be used on the EVO 1 Weatherproof panel

Ref VEIP-PSU100W



200W AC POWER SUPPLY WEATHERPROOF

with XLR3 IP65 and PowerCon TRUE1 aerial connectors on quick link mount + Schuko Power cable for EVO 2 IP54

NOTE: this AC power supply can exclusively be used on the EVO 2 Weatherproof panel

Ref VEIP-PSU200W



200W AC POWER SUPPLY WEATHERPROOF

with XLR3 IP65 and PowerCon TRUE1 aerial connectors on quick link mount + Schuko Power cable for EVO 2x2 IP54

NOTE: this AC power supply can exclusively be used on the EVO 2x2 Weatherproof panel

Ref VEIP-PSU400W





**EVO and MINI VLOCK
ADAPTER**

on plate with XLR3 IP54 connector

Ref VM-VLOCKIP54



**EVO and MINI VLOCK
ADAPTER**

on plate with XLR3 right angle
connector

Ref VM-VLOCKA

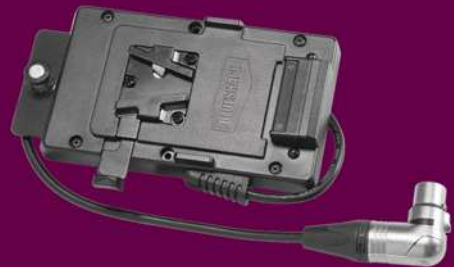

**EVO and MINI VLOCK
ADAPTER**

on plate with XLR3 right angle
connector

Ref VM-GOLDA



**EVO DOUBLE VLOCK
ADAPTER**

on quick link EVO plate with
XLR3 connector

Ref VE-DVLOCK





**EVO DOUBLE VLOCK
IP54 ADAPTER**

on quick link EVO plate with
XLR3 IP54 connector

Ref VE-DVLOCKIP54



**EVO DOUBLE GOLD
ADAPTER**

on quick link EVO plate with
XLR3 connector

Ref VE-DGOLD



**XLR-3 EXTENSION
CABLE**

4.5 meters/ 15 feet XLR-3

Ref CAB-XLR3DCC4.5M





**EVO 1 BALL HEAD
CENTER MOUNT**

with 16mm baby receiver on
quick link mount for EVO 1 and
MINI series

Ref VM-QLS



**EVO 2 BALL HEAD
CENTER MOUNT**

with 28mm junior pin on
quick link mount

Ref VE-QLS



**EVO POLE OPERATED
YOKE**

EVO Kits

- Ref VE1-YPO (EVO 1)
- Ref VE2-YPO (EVO 2)
- Ref VE2X2-YPO (EVO 2x2)





EVO SNAPGRID 40°
FOLDABLE by DopChoice
Including transport bag

- Ref VE1-SG (EVO 1)
- Ref VE2-SG (EVO 2)
- Ref VE2X2-SG (EVO 2x2)

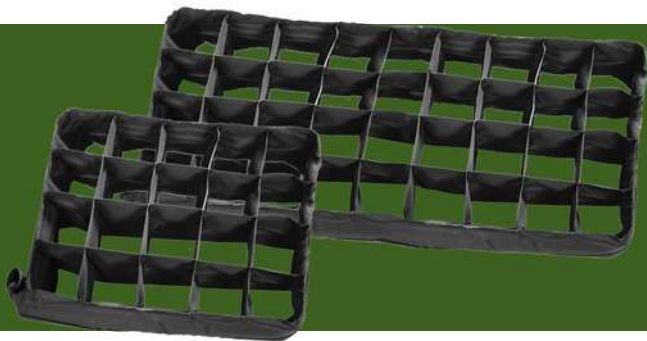

EVO SNAPGRID for SNAPBAG
FOLDABLE by DopChoice
Including transport bag

- Ref VE1-SGXSB (EVO 1)
- Ref VE2-SGXSB (EVO 2)
- Ref VE2x2-SGXSB (EVO 2X2)



EVO SNAPBAG
FOLDABLE by DopChoice
Including transport bag

- Ref VE1-SB (EVO 1)
- Ref VE2-SB (EVO 2)
- Ref VE2X2-SB (EVO 2x2)



EVO BARN DOORS

kit of 4x barndoors for EVO

- Ref VE1-RB (EVO 1)
- Ref VE2-RB (EVO 2)
- Ref VE2X2-RB (EVO 2x2)





EVO RABBIT EARS FRAME

by DopChoice

square for 1x1 panel or
rectangular for 2x1 panel

- Ref 1X1-RABBITSQ (EVO 1)
- Ref 2X1-RABBITSQ (EVO 2)
- Ref 2X2-RABBITSQ (EVO 2x2)

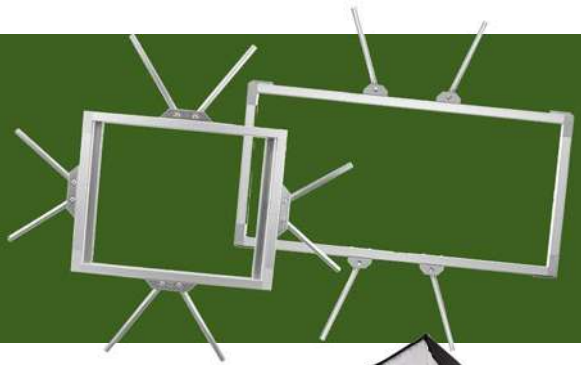

EVO OCTA SNAPBAG

FOLDABLE by DopChoice

for RABBIT EARS mount

- Ref OCTA-SBR03
- Ref OCTA-SBR05
- Ref OCTA-SBR07

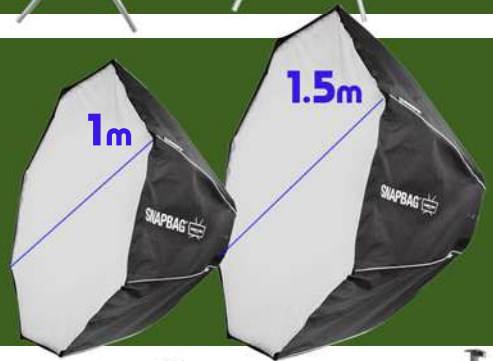

EVO SLOT KIT

- Ref VE1-SLOTKIT (EVO 1)
- Ref VE2-SLOTKIT (EVO 2)
- Ref VE2X2-SLOTKIT (EVO 2x2)





**SPLITTER DMX
AERIAL IN/OUT**

VELVET DMX aerial IN/OUT
SPLITTER

Ref THE-DMXINOUT



**XLR-5 DMX EXTENSION
CABLE**

3 meters/ 10 feet XLR-5

Ref DMX-DMX3M



**PORTABLE DMX DESK
UNIVERSAL and WIRELESS**

transmitter (8 x Fader/512Ch)
INCLUDES: 1 Antenna x1 & 1
AC adpt (w/UK/EU/US plugs)

NOTE: this product is only compatible with
EVO Weatherproof panel

Ref ACC-DESK-TX8



EVO ROUTER Wi-fi

automatic connection to
remotely control EVO through
Art-Net and VELVET GOYA
App

Ref VE-ROUTER





CORDURA SOFT BAG

Semi rigid Cordura carrying bag for 1x EVO 1 kit

Ref VE1-BAG



CORDURA SOFT BAG

Semi rigid Cordura carrying bag for 1x EVO 2 kit

Ref VE2-BAG



FLIGHT CASE

Hard case with wheels for 1x EVO 2x2 kit

Ref VE2X2-CASE



Place the EVO panel with the lighting diffuser surface facing downwards on an even and clean surface.

Align the adjustable Yoke with the VELVET EVO panel and put the 16mm baby receiver in the bottom part (EVO STUDIO includes an Euro28 junior pin instead).

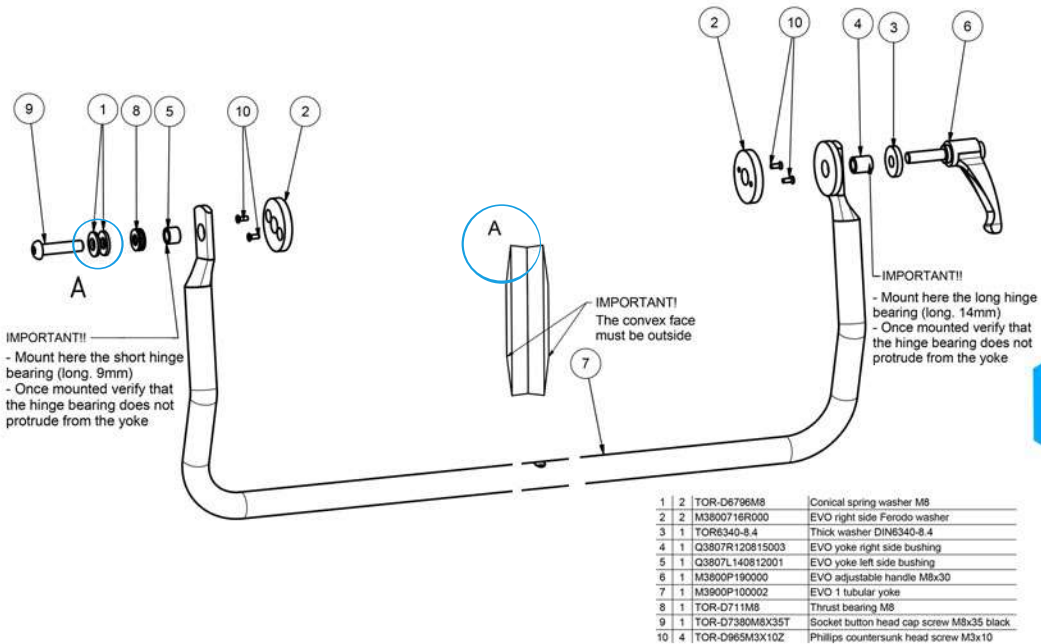

Assemble the Yoke to the LED panel by using the mounting kit of bolts, washers and adjustable handle. First mount the handles with the metric M8 metal washer then insert the hinge bearing between the Yoke and the LED panel.



If the heat sink surface is facing to you and the VELVET logo on control display shows in the correct position, mount the long hinge bearing on the left side of the panel together with the M8 screw and the short hinge bearing on the right side of the panel together with the adjustable handle

VELVET EVO 2x2 YOKE to PANEL ASSEMBLY

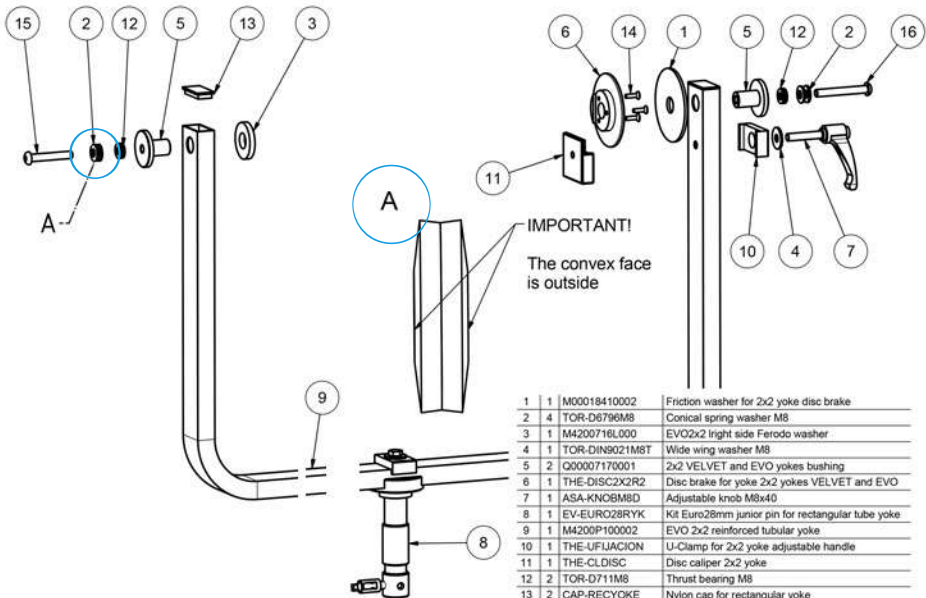
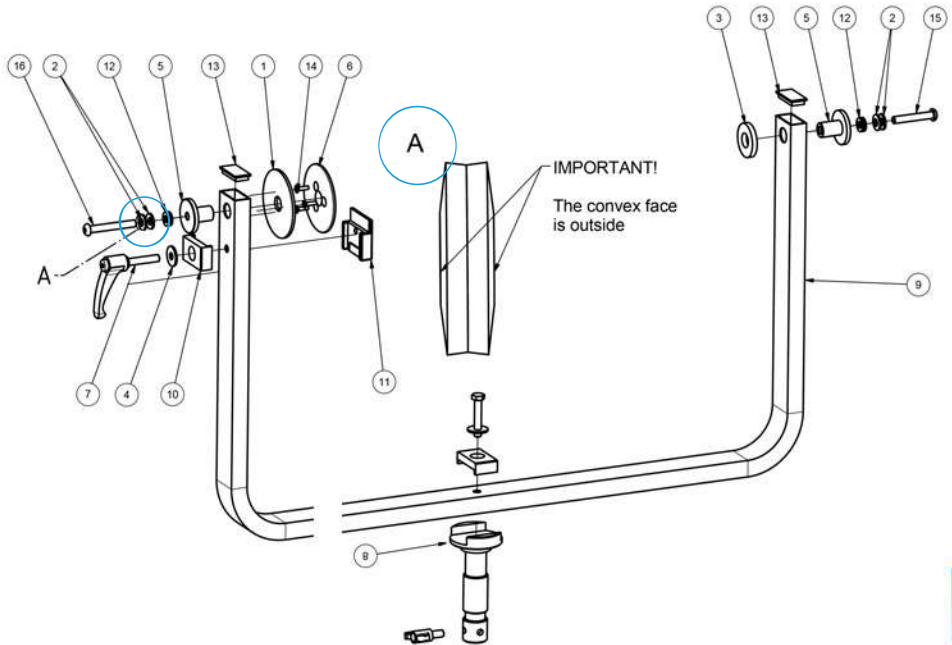

1	1	M00018410002	Friction washer for 2x2 yoke disc brake
2	4	TOR-D6796M8	Conical spring washer M8
3	1	M4200716L000	EVO2x2 right side Ferodo washer
4	1	TOR-D1N8021M8T	Wide wing washer M8
5	2	Q00007170001	2x2 VELVET and EVO yokes bushing
6	1	THE-DISC2X2R2	Disc brake for yoke 2x2 yokes VELVET and EVO
7	1	ASA-KNOBMBD	Adjustable knob M8x40
8	1	EV-EURO28RYK	Kit Euro28mm junior pin for rectangular tube yoke
9	1	M4200P100002	EVO 2x2 reinforced tubular yoke
10	1	THE-UFLJACION	U-Clamp for 2x2 yoke adjustable handle
11	1	THE-CLDISC	Disc caliper 2x2 yoke
12	2	TOR-D711M8	Thrust bearing M8
13	2	CAP-RECYOKE	Nylon cap for rectangular yoke
14	3	TOR-D965M4X15T	Phillips countersunk head screw M4x15
15	1	TOR-D7380M8X50	Socket button head cap screw DIN7380 M8x50
16	1	TOR-D7380M8X60	Socket button head cap screw DIN7380 M8x60

The VE2-YPO kit is valid for the following VELVET products: VELVET EVO 2 WEATHERPROOF and VELVET EVO 2 STUDIO



- 1 ● Remove the Ferodo washer fixed with two Philips countersunk head screws M4x10 black on the right side panel cover as show in the picture. You can identify the "right side" because is where the display and tactile buttons are located.

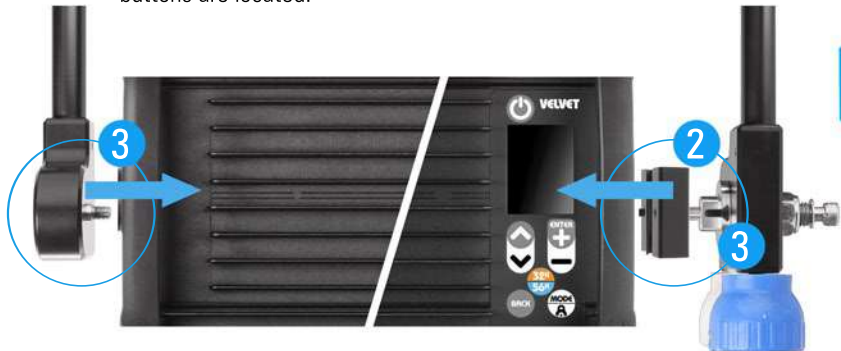

- 2 ● Install the supplied adapter plate using the original two Philips countersunk head screws M4x10 black.
- 3 ● Display the panel over a table with the back facing to you and the display and tactile buttons to the right. Mount the Pole Operated Yoke with the tilt gear box facing to the right. Insert the Hexagon socket head cap screw M8x70 with its washer through the PO yoke gear box and through the adapter plate already installed on the panel. Use the Hexagon socket head cap screw M8x40 with its washer to fix the left side of the yoke with the left side of the panel.

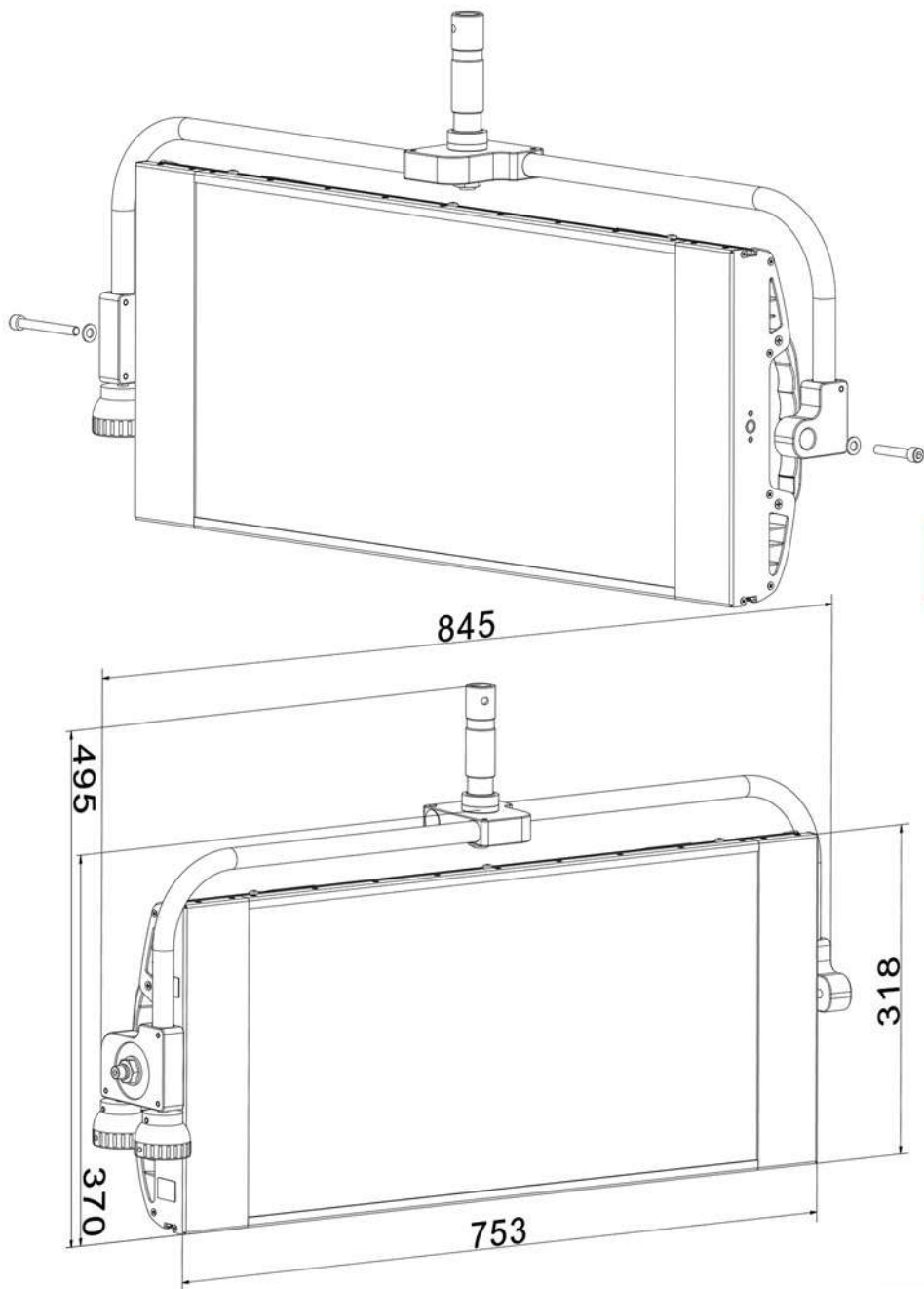

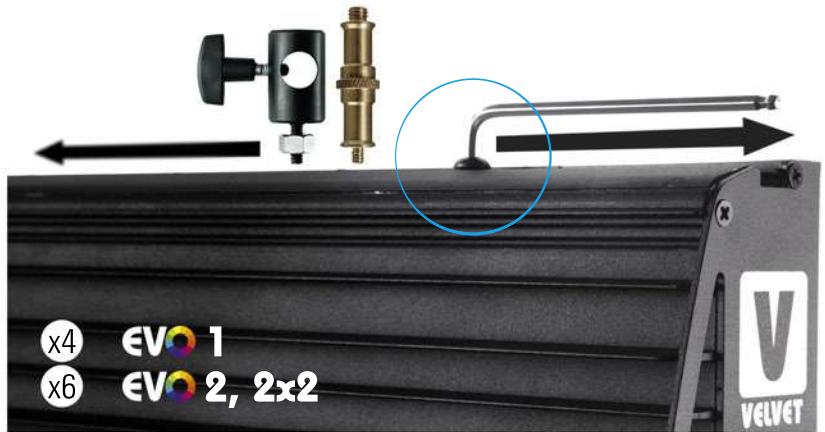

RIGGING OPTIONS

VELVET EVO panels have been designed to be easily installed and rigged up on studio, special locations and vehicles. They can be rigged up in many ways through the adjustable yoke, swivel ball head or by using the sliding 1/4-20" threads and bolts located on both top and bottom of any VELVET panel.

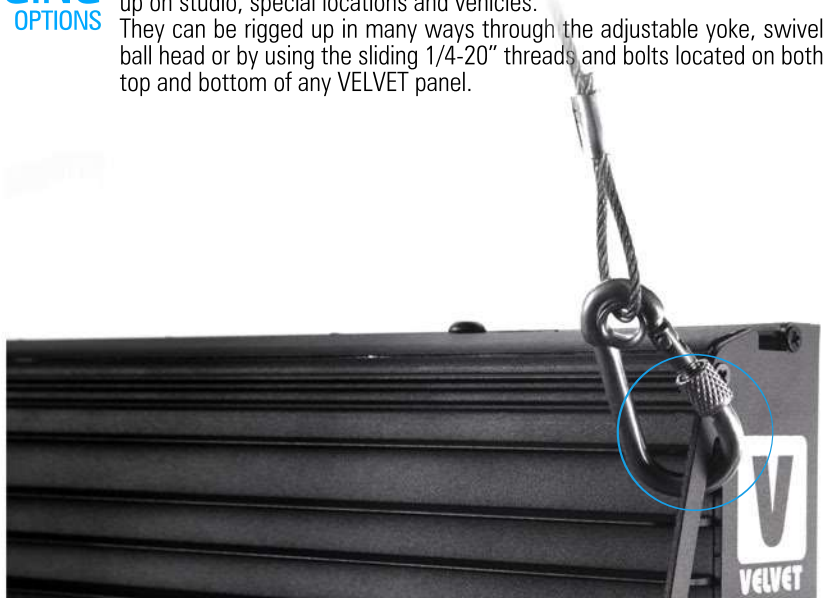

SECURITY CABLES

The LED panel is provided with several holes specially design to insert one or more snaps and their safety cable.



When a VELVET EVO panel and any other component is mounted in a hanging position it must be secured with a safety cable rated at a minimum of ten times the weight of the light fixture including its accessories.

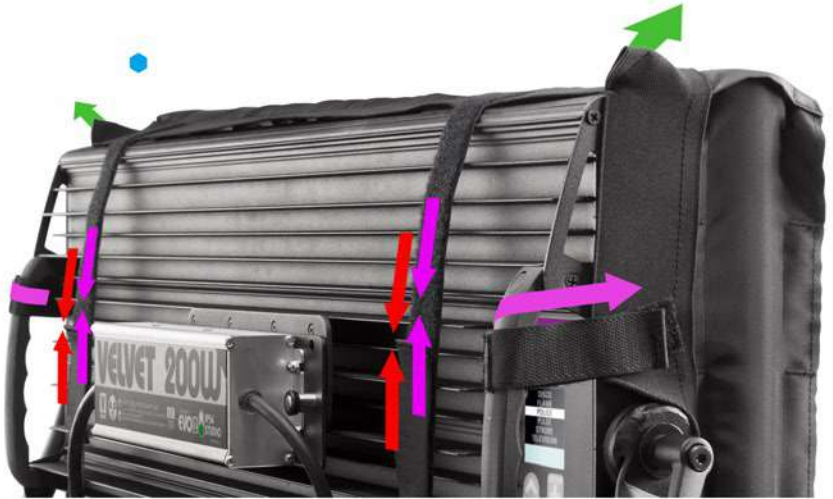

SNAPGRID INSTALLATION

- Open the Snapgrid and secure it over the EVO PANEL by hooking the rear velcro strips
- Pull the elastics on all 4 corners over the housing starting with the TOP corners. Pull the white cord



- Secure the Snapgrid sliding the side velcro strips through the fixture's left and right handles. Bring the back velcro strips again to the proper tension so that the Snapgrid is visually centered with respect to the front screen.



SNAPBAG INSTALLATION

- Secure the drawer by hooking the main rear velcro strip
- Place and secure the Snapbag by passing the 4 side velcro strips through the fixture's left and right handles
- Guide the Snapbag's white elastic cord around the EVO fixture using the four white elastic handles and secure the corners with the 4 black tensors.



- At the end of process, secure again all velcros and tensors. Check the front corners and finish the assembly using the central main tensioners so that the assembly looks equal, centered and firm.

FLAMEPROOF
RATING

The Snapgrid and Snapbag has been manufactured with black cloth which meets the flameproof standards UNE EN 1101 and EN 13772.





BARNDOOR INSTALLATION

- Position the VELVET EVO panel with the light pointing up. Unscrew the 6 adjustable 1/4-20" threads and bolts located on both top and bottom. Then, place and screw the Barndoors to secure it.



EVO 1, 2 and 2x2 STUDIO dustproof IP51 maintenance free soft light LED panels have been designed to be exclusively AC powered with their own power supply fixed on the back of the panel.

AC POWER

90 to 264 VAC

Connect the XLR3 to the connector located on the back of the panel.

Connect the power cable to the PowerCon TRUE1 connector located on the left side of the power supply and the power plug with a mains power outlet.



Secure the AC Power Supply plate by inserting the locking pin into place.



Use only an original VELVETLight power supply units and an VELVETLight connector cable. The use of other power supply units and connector cables might cause malfunction and damage of the EVO panel.



For protection from electric shock, always connect the external power supply unit electrically to ground (earth) when connected to AC power. The AC mains power supply must be fitted with a fuse or circuit breaker and ground-fault (earth-fault) protection.



Always connect the EVO product direct to AC power through VELVET AC Power Supply. Do not connect it to a dimmer-system. Doing so will damage the product.

The EVO weatherproof IP54 location panels can be powered by AC power, by any battery from 12 to 35 VDC (EVO 1)/ 24 to 35 VDC (EVO 2) or by any Vlock or Gold batteries and it delivers the same full output both AC and DC powered.

BATTERY

12 to 35 VDC (EVO 1)
24 to 35 VDC (EVO 2)

Connect any battery from 12 to 35 VDC to the XLR3 connector located at the back of the EVO 1 Weatherproof IP54 panel.

Connect any battery from 24 to 35 VDC to the XLR3 connector located at the back of the EVO 2 Weatherproof IP54 panel.



When powering VELVET EVO from an external battery through the XLR3 connector check the proper polarity as shown in the picture at the side of the panel.

To ensure maximum performance of the equipment use only high-load capacity batteries with a high continuous draw meaning a Discharge Current of at least 7A.

BATTERY

Vlock or Gold Battery

EVO 1 can also be directly powered with only one 14.4V Vlock or Gold battery delivering full power light around one hour (90Wh 14.4V x 1).

EVO 2 can also be directly powered with two 14.4V Vlock or Gold batteries delivering full power light around one hour (200Wh 14.4V x 2).

Attach the quick link double Vlock or Gold plate by aligning the center pin of the mounting plate to the center hole on the panel docking plate. Rotate the Vlock or Gold plate clockwise until the four shoulder rivets drop into their receptacles. A locking pin will snap into place when the plate is properly locked.

Connect the XLR3 to the connector located on the back of the panel.



EVO 2 Weatherproof panel exclusively runs when two Vlock (or Gold Mount) batteries are inserted on the mounts.

Secure the Vlock or Gold plate by inserting the locking pin into place.



AC POWER 90 to 264 VAC

Attach the quick link AC Power Supply plate by aligning the center pin of the mounting plate to the center hole on the panel docking plate. Rotate the AC Power Supply plate clockwise until the four shoulder rivets drop into their receptacles. A locking pin will snap into place when the plate is properly locked.

Connect the XLR3 to the connector located on the back of the panel, connect the power cable to the PowerCon TRUE1 connector located on the left side of the power supply and the power plug with a mains power outlet.



Secure the AC Power Supply plate by inserting the locking pin into place.



Use only an original VELVET power supply unit and a VELVET connector cable. The use of other power supply units and connector cables might cause malfunction and damage of the EVO panel.



For protection from electric shock, always connect the external power supply unit electrically to ground (earth) when connected to AC power. The AC mains power supply must be fitted with a fuse or circuit breaker and ground-fault (earth-fault) protection.



Always connect the EVO product direct to AC power through VELVET AC Power Supply. Do not connect it to a dimmer-system. Doing so will damage the product.

POWER ON/OFF

When the EVO power switch is turned on after 3 seconds the CTT mode will be shown on the color display. The EVO will show the last white light and color settings and the panel source will emit light only as per the last setting. To light on/off the light source you need to press the upper light power button (not the power switch).

When the display background is dark means the light source is OFF. When the display background is light means the light source is ON.

The menu system and TFT backlight are set, by default, to “sleep” after one minute of inactivity showing a VELVET logo over a black background.



The lamp head is equipped with power LED. Due to their high light-output intensity don't stare directly into the light source.

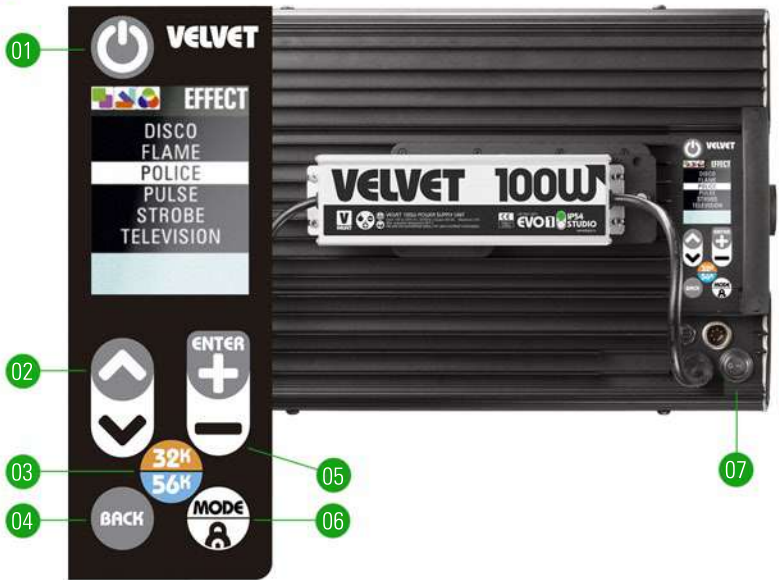

- | | PRIMARY FUNCTION | SECONDARY FUNCTION |
|----|--|--|
| 01 | POWER Powers on/off the light source. | |
| 02 | UP & DOWN Scrolls up and down through available options. | |
| 03 | 32K/56K Goes to preset 3200K and 5600K. | |
| 04 | BACK Cancels the current operation and returns to the previous screen. | |
| 05 | ENTER/PLUS Increases or decreases a value or menu choice by one. Pressing and holding the button increases the rate of change. | Activates a menu selection or stores a value. |
| 06 | MODE/LOCK Changes mode page as a main function. | |
| 07 | POWER SWITCH | Keeping pressed for 3 seconds locks every button. To unlock press again along 3 seconds. Lockout does not affect remote wire or wireless access to fixture settings. |

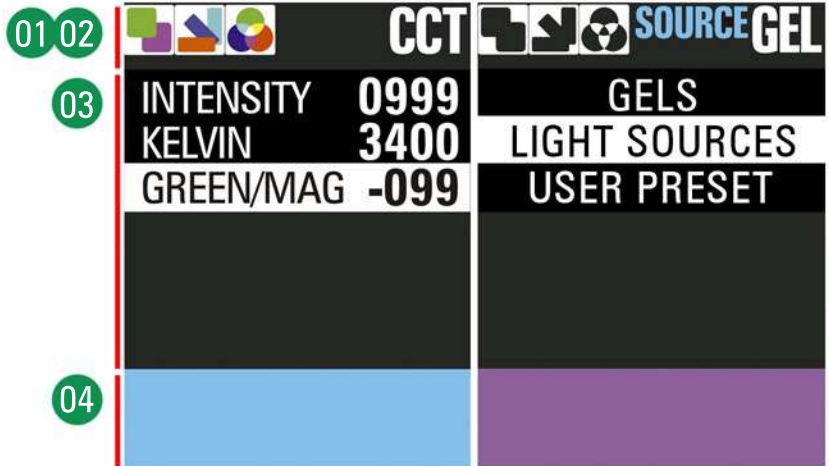

01 WARNING ICONS

Inform about the global status of the fixture. The icons are automatically turned ON or OFF depending on the changes the user has made across some specific menu options

When any icon is turned ON means that the function is activated (appear as a colored icon), otherwise the feature is disabled (grey icon)

The WARNING icons are:

- GREEN/ MAGENTA
- GEL selected
- COLOR light selected

02 CONTROL MODE INFORMATION

The two icons on the top right show the CONTROL MODE and the active option within each mode. The available MODES/ Active OPTIONS are:

- CCT
- HSI+
- GEL
- RGB+
- EFFECT
- SETTINGS

03 ADJUSTABLE PARAMETERS

Every control mode will show below its own adjustable parameters and options

04 COLOR AREA

Shows a real time emulation of every color adjustment as a visual reference of the light emitted by the fixture



MODE

CCT	HSI+	RGB+	GEL	EFFECTS
INTENSITY KELVIN GREEN/MAGENTA	INTENSITY HUE SATURATION KELVIN	INTENSITY COLD WHITE WARM WHITE RED GREEN BLUE	GELS LIGHT SOURCES PRESETS	DISCO Light intensity Loop speed Default values FLAME Light intensity Hue Saturation Kelvin Flicker speed Default values POLICE Light intensity Loop speed Color combination Default values PULSE Light intensity Hue Flash time Loop speed Fade out Default values STROBE Light intensity Kelvin Flash time Default values TELEVISION Light intensity Hue Loop speed Default values

SETTINGS

DIMMING CURVE	DMX-RDM	REMOTE CONTROL	DISPLAY	ABOUT
LINEAR (default) LOGARITHMIC EXPONENTIAL	STATUS <input type="checkbox"/> master <input type="checkbox"/> slave ADDRESS DMX MODE	LumenRadio (only EVO IP54) CONNECTION <input type="checkbox"/> active <input type="checkbox"/> waiting QUALITY STATE <input type="checkbox"/> linked <input type="checkbox"/> free DMX ENABLE <input type="checkbox"/> on <input type="checkbox"/> off UNLINK	BRIGHTNESS LOW/ MEDIUM/ MAXIMUM	FACTORY PRESET FIRMWARE UPDATE USB FUNCTIONS
		WI-FI CONNECTION <input type="checkbox"/> active <input type="checkbox"/> waiting IP MAC RSSI CONNECT/ DISCONNECT		
		BLUETOOTH CONNECTION <input type="checkbox"/> active <input type="checkbox"/> waiting CONNECT/ DISCONNECT		
		ETHERNET (only EVO studio) CONNECTION <input type="checkbox"/> active <input type="checkbox"/> waiting IP MAC		

The EVO can be fully, quickly and easily controlled in any possible way, locally or wirelessly, or from your smartphone with VELVET GOYA App. The EVO panel control options are:

- Onboard control with tactile shock-resistant buttons & color display
- Wire control modes:
 - DMX-RDM through XLR-5 connector
 - Art-Net through Ethernet RJ-45 connector (only available on EVO STUDIO)
- Wireless control modes:
 - DMX-RDM with CRMX LumenRadio (only EVO Weatherproof)
 - Art-Net through VELVET Wi-Fi
 - Bluetooth

CONTROL PRIORITIES

Please consider the following priority rules whenever you will control EVO fixture through more than one control method:

- | | |
|-------------------------------|------------|
| ● Wire DMX-RDM | priority 1 |
| ● Wire Art-Net | priority 2 |
| ● Wireless LumenRadio DMX-RDM | priority 3 |
| ● Wireless Wi-fi Art-Net | priority 4 |
| ● On-board control | priority 5 |

In case of signal loss the EVO fixture will hold the last command received following the above listed priority rules.

ON-BOARD CONTROL

The EVO 5LED technology (R+G+B+W+CW) offers clear advantages on light quality and color adjustment:

- More saturated colors
- More natural white light with much wider color gamut
- Higher degree of color control

EVO technology has two important control advantages:

- Any base white light color temperature can be set to apply any color or gel.
- Settings on one mode can be fine-tuned in any other.

Press  to select the Control Mode.

When in sub-menus, pressing  returns you to the previous display.

When in sub-menus, pressing  always returns you to the previously selected Mode.



CCT mode

Select the parameter line with  

Directly set the value by pressing 

Any time GREEN/MAGENTA will be set out of ZERO, the GREEN/MAGENTA icon will change to ON as a warning that standard white light is offset.

The color temperature can be selected as a base light from 2500°K to 10000°K in steps of 100°.



HSI+ mode

On EVO traditional HSI mode becomes HSI+ because you can select any base white light from 2500°K to 10000°K in steps of 100°.

Select the parameter line with  

Directly set the value by pressing 

When the Saturation value is 0 the light emitted by EVO is only white light and therefore HUE will not have any effect.



When the Saturation value is between 1 and 100 the light emitted by EVO includes color tint and therefore HUE will be active.







GEL mode

The GELS, LIGHT SOURCES or USER PRESETS selected from this mode can be fine-tuned in RGB+ mode by pressing ENTER button.

EVO has no limits to your creativity.

Select the line "GELS" or "LIGHT SOURCES" with  

Press  to select the function and   to select the desired Gel or Light Source.

Press  to load the selected Gel. Pressing   again you can fully adjust the selected GEL or Light Source Intensity, Red, Green, Blue, White and Warm White values



Once you select any GEL or LIGHT SOURCE, the GEL icon will change to ON warning that the light emitted is not standard white any more

Press  along 3 seconds to save any white light or color settings (Intensity, Red, Green, Blue, White and Warm White values) and load them back as User presets. A total of five user presets can be saved.

The presets can be loaded locally or remotely through DMX.

The presets can also be up loaded or downloaded to or from an external memory stick through the miniUSB port to share them.

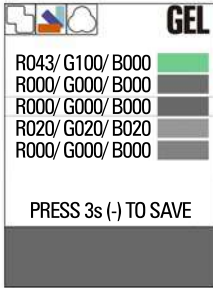

PRESETS

EVO allows to save any white light or color settings (Intensity, Kelvin, Green/magenta, Hue, Saturation or Gels) and load them back as User presets. A total of TEN user presets can be saved. The presets can be loaded locally or remotely through DMX

The presets can also be uploaded or downloaded to or from an external memory stick through the miniUSB port to share them

To SAVE a USER PRESET

Select any user preset line and push along two seconds to save.

To LOAD a USER PRESET

Select any user preset line and push along two seconds to load

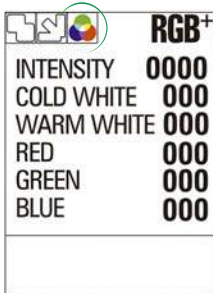

RGB+ mode

On EVO traditional RGB mode becomes RGB+ because you have 5 LED channels to play with.

Select with and directly set by pressing

Once you set any color parameter out of ZERO, the RGB COLOR icon will change to ON warning that the light emitted is not standard white any more



EFFECT mode

EVO effects replace many effects devices with its tunable effects.

EVO allows to customize any effect by adjusting several parameters.

On any effect you can always use your personally adjusted effect or go back to the default values. You can save or load your own effects.

Select EFFECTS with and press to select the function.

Select the desired Effect with

Load or remove the selected Effect by pressing



- 01** DISCO
Changes colors, color temperature and intensity in a loop. Tune it to create new personal effects by adjusting:
LIGHT INTENSITY
LOOP SPEED
- 02** FLAME
A flickering effect simulating a burning flame by color temperature and intensity fades combined with pause periods. You can adjust it to create new personal effects from a weak candle to a powerful fire or even a water effect.
LIGHT INTENSITY
HUE
SATURATION
KELVIN
FLICKER SPEED
- 03** POLICE
Blue and red flashing effect simulating an emergency vehicle. Tune it to create new personal effects like ambulance or fire truck.
LIGHT INTENSITY
LOOP SPEED
COLORS
- 04** PULSE
Light pulse effect with soft fade in and fade out.
LIGHT INTENSITY
HUE
FLASH TIME
LOOP SPEED
FADE OUT
-  **05** STROBE
Risk of injury or death due to epileptic attack or breakdown. Announce a strobe lighting effect is going to be used.
White light or color strobe effect.
FLASH INTENSITY
KELVIN
FLASH TIME (adjustable from 50 flashes per second up to 1 flash per second)
- 06** TELEVISION
Emulates a tv screen effect by changing among different white lights and soft colors with intensity variation. You can adjust:
LIGHT INTENSITY
HUE
LOOP SPEED



ABOUT/ Dimming Curve

The dimming curve is the correlation between the change in the value of the dimming control and the actual change in the fixture's light intensity. Curve is also the extent to which the fixture delays its response time to the control signal in order to smooth dimming.

Select the Curve with and directly set it pressing

Choose among Linear (default), Logarithmic, Exponential.

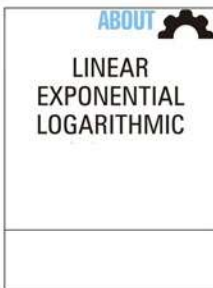

LINEAR (default)

Linear has no curve. Brightness levels correlate exactly with the value of the dimming control.

Moderate lag in response for good dimming smoothness. Linear allows quick jumps in brightness. This is the default setting.

EXPONENTIAL

The resolution is high at lower intensity levels and low at higher intensity levels. It provides moderate lag in response for good smoothness and allows quick jumps in brightness. Suitable for most applications.

Use this dimming curve when you need a high resolution at low intensity levels.

LOGARITHMIC

The resolution is low at lower intensity levels and high at higher intensity levels. Use this dimming curve when you need a high resolution at high intensity levels.

The EVO offers eight DMX control Modes on 8-bit and eight more on 16-bit.
Use the 8-bit modes with basic controllers like dimmer consoles. The DMX mode can be selected on the EVO DMX-RDM menu.

The control mode named “Changing mode” allow to dynamically and remotely change the DMX mode through a DMX console by changing the channel 2 value on 8-bit or channel 3 value on 16-bit.
Please refer to “DMX Map chart 8-bit” and “DMX Chart 16-bit”.

The 16-bit modes use two channels for most parameters and provide higher resolution compared to the 8-bit modes. One channel sets the coarse value between 0 and 255 of the function while each step is divided in 256 increments using the fine channel.

STATUS DMX-RDM

To select DMX-RDM Status (Master/Slave)

Push button to select “SETTINGS”

Select “DMX-RDM” with and press

Select “STATUS” with and press

Push to select MASTER mode, push to select SLAVE mode.

Slave setting is set as default. Every time the EVO is powered off the DMX mode will be reset to Slave mode.

IMPORTANT NOTE

In order to properly control any Slave EVO fixture from a Master EVO you need to set the same DMX mode and the same DMX channel on both Master and Slave fixtures.

ADDRESS DMX

Select the DMX Address with Set its value pressing

CONTROL MODE DMX-RDM

Push button to select “SETTINGS”

Select “DMX-RDM” with and press

Select “DMX mode” with and press

SIGNAL LOSS

In case of DMX signal loss the EVO fixture will hold the last values received.



	01 CHANNEL	02 CHANNEL	03 CHANNEL	04 CHANNEL	05 CHANNEL	06 CHANNEL	07 CHANNEL	08 CHANNEL	09 CHANNEL	10 CHANNEL	11 CHANNEL
CCT	MASTER INTENSITY Values: 0-255 Percent: 0-100	KELVIN 2500K to 10000K Values: 0-255 Percent: 0-100	GREEN to MAGENTA 100M to 100G Value 0: Neutral 1-121: 100M to 1M, 122-132: Neutral, 133-255: 1G to 100G								
CCT & HSI	MASTER INTENSITY Values: 0-255 Percent: 0-100	KELVIN 2500K to 10000K Values: 0-255 Percent: 0-100	GREEN to MAGENTA 100M to 100G Value 0: Neutral 1-121: 100M to 1M, 122-132: Neutral, 133-255: 1G to 100G	SATURATION Values: 0-255 Percent: 0-100	HUE (0 to 359 degrees) Values: 0-255 Percent: 0-100						
CCT & RGB	MASTER INTENSITY Values: 0-255 Percent: 0-100	KELVIN 2500K to 10000K Values: 0-255 Percent: 0-100	GREEN to MAGENTA 100M to 100G Value 0: Neutral 1-121: 100M to 1M, 122-132: Neutral, 133-255: 1G to 100G	SATURATION Values: 0-255 Percent: 0-100	RED	GREEN	BLUE				
RGB+	MASTER INTENSITY Values: 0-255 Percent: 0-100	RED	GREEN	BLUE	WHITE	COLD WHITE					
GELS	MASTER INTENSITY Values: 0-255 Percent: 0-100	KELVIN 2500K to 10000K Values: 0-255 Percent: 0-100	GREEN to MAGENTA 100M to 100G Value 0: Neutral 1-121: 100M to 1M, 122-132: Neutral, 133-255: 1G to 100G	SATURATION Values: 0-255 Percent: 0-100	GEL NUMBER Values: 0-255 Percent: 0-100	RESERVED FUTURE USE					
LIGHTSOURCES	MASTER INTENSITY Values: 0-255 Percent: 0-100	KELVIN 2500K to 10000K Values: 0-255 Percent: 0-100	GREEN to MAGENTA 100M to 100G Value 0: Neutral 1-121: 100M to 1M, 122-132: Neutral, 133-255: 1G to 100G	SATURATION Values: 0-255 Percent: 0-100	LIGHTSOURCE NUMBER Values: 0-255 Percent: 0-100						
PRESETS	MASTER INTENSITY Values: 0-255 Percent: 0-100	KELVIN 2500K to 10000K Values: 0-255 Percent: 0-100	GREEN to MAGENTA 100M to 100G Value 0: Neutral 1-121: 100M to 1M, 122-132: Neutral, 133-255: 1G to 100G	SATURATION Values: 0-255 Percent: 0-100	PRESET NUMBER Values: 0-255 Percent: 0-100						
EFFECTS	MASTER INTENSITY Values: 0-255 Percent: 0-100	EFFECT NUMBER Values: 0-255 Percent: 0-100	PARAMETER #1	PARAMETER #2	PARAMETER #3	PARAMETER #4	PARAMETER #5	RESERVED FUTURE USE	RESERVED FUTURE USE	RESERVED FUTURE USE	
CHANGING	MASTER INTENSITY Values: 0-255 Percent: 0-100	MODE 1 0-9: CCT	KELVIN 2500K to 10000K Values: 0-255 Percent: 0-100	GREEN to MAGENTA 100M to 100G Value 0: Neutral 1-121: 100M to 1M, 122-132: Neutral, 133-255: 1G to 100G							
CHANGING	MASTER INTENSITY Values: 0-255 Percent: 0-100	MODE 2 10-19: CCT & HSI	KELVIN 2500K to 10000K Values: 0-255 Percent: 0-100	GREEN to MAGENTA 100M to 100G Value 0: Neutral 1-121: 100M to 1M, 122-132: Neutral, 133-255: 1G to 100G	SATURATION Values: 0-255 Percent: 0-100	HUE (0 to 359 degrees) Values: 0-255 Percent: 0-100					
CHANGING	MASTER INTENSITY Values: 0-255 Percent: 0-100	MODE 3 20-29: RGB +	KELVIN 2500K to 10000K Values: 0-255 Percent: 0-100	GREEN to MAGENTA 100M to 100G Value 0: Neutral 1-121: 100M to 1M, 122-132: Neutral, 133-255: 1G to 100G	SATURATION Values: 0-255 Percent: 0-100	RED	GREEN	BLUE			
CHANGING	MASTER INTENSITY Values: 0-255 Percent: 0-100	MODE 4 30-39: GELS	KELVIN 2500K to 10000K Values: 0-255 Percent: 0-100	GREEN to MAGENTA 100M to 100G Value 0: Neutral 1-121: 100M to 1M, 122-132: Neutral, 133-255: 1G to 100G	SATURATION Values: 0-255 Percent: 0-100	GEL NUMBER Values: 0-255 Percent: 0-100	RESERVED FUTURE USE				
CHANGING	MASTER INTENSITY Values: 0-255 Percent: 0-100	MODE 5 40-49: LIGHTSOURCES	KELVIN 2500K to 10000K Values: 0-255 Percent: 0-100	GREEN to MAGENTA 100M to 100G Value 0: Neutral 1-121: 100M to 1M, 122-132: Neutral, 133-255: 1G to 100G	SATURATION Values: 0-255 Percent: 0-100	LIGHTSOURCE NUMBER Values: 0-255 Percent: 0-100					
CHANGING	MASTER INTENSITY Values: 0-255 Percent: 0-100	MODE 6 50-59: PRESETS	KELVIN 2500K to 10000K Values: 0-255 Percent: 0-100	GREEN to MAGENTA 100M to 100G Value 0: Neutral 1-121: 100M to 1M, 122-132: Neutral, 133-255: 1G to 100G	SATURATION Values: 0-255 Percent: 0-100	PRESET NUMBER Values: 0-255 Percent: 0-100					
CHANGING	MASTER INTENSITY Values: 0-255 Percent: 0-100	MODE 7 60-69: EFFECTS	EFFECTS NUMBER Values: 0-255 Percent: 0-100	PARAMETER #1	PARAMETER #2	PARAMETER #3	PARAMETER #4	PARAMETER #5	RESERVED FUTURE USE	RESERVED FUTURE USE	RESERVED FUTURE USE
CHANGING	MASTER INTENSITY Values: 0-255 Percent: 0-100	MODE 8 70-79: EFFECTS	RED	GREEN	BLUE	WHITE	COLD WHITE				



01	Light salmon	59	Minusgreen
02	No color blue	60	Minusgreen 1/2
03	Twilight	61	Minusgreen 1/4
04	Scarlet	62	Minusgreen 1/8
05	Fire	63	Flame
06	Chroma orange	64	Golden amber
07	Apricot	65	Light salmon pink
08	Deep straw	66	Light bastard amber
09	Middle rose	67	Salmon pink
10	Medium amber	68	Medium pink
11	Medium bastard amber	69	No color pink
12	Orange	70	Pale apricot
13	Deep amber	71	Rose gold
14	Yellow	72	Light rose
15	Light amber	73	Pale amber gold
16	Straw tint	74	Medium straw
17	Straw	75	Light straw
18	No color straw	76	Pale yellow
19	Dark yellow green	77	Medium yellow
20	Primary green	78	Light green
21	Peacock blue	79	Blue green
22	Mist blue	80	Lime green
23	Steel blue	81	Medium blue green
24	Moonlight blue	82	Medium green
25	Pale blue	83	Pale yell green
26	Spec. lavender	84	Kelly green
27	Pale violet	85	Nile blue
28	Deep blue	86	Cool blue
29	Daylight blue	87	Azure blue
30	Bright blue	88	Light sky blue
31	Light lavender	89	Sky blue
32	Lavender	90	Lilac
33	Mauve	91	Middle lavender
34	Deep lavender	92	True pink
35	Pale lavender	93	Rose purple
36	Surprise pink	94	Hamburg lavender
37	Dark magenta	95	Hamburg rose
38	Flesh pink	96	Deep pink
39	Folies pink	97	Light flame
40	Bright rose	98	Medium salmon pink
41	Rose pink	99	Salmon
42	Pale rose	100	85
43	Bright pink	102	Cts
44	Ctb double	103	Cts 1/2
45	Ctb	104	Cts 1/4
46	Ctb 1/2		
47	Ctb 1/4		
48	Ctb 1/8		
49	Ctb 3/4		
50	Cto		
51	Cto 1/2		
52	Cto 1/4		
53	Cto 1/8		
54	Cto 3/4		
55	Plusgreen		
56	Plusgreen 1/2		
57	Plusgreen 1/4		
58	Plusgreen 1/8		



EFFECT	#DMX VAL	PARAMETER #1	PARAMETER #2	PARAMETER #3	PARAMETER #4			
DISCO	0	LOOP SPEED				RESERVED FOR FUTURE USE	RESERVED FOR FUTURE USE	RESERVED FOR FUTURE USE
FLAME	1	HUE	SATURATION	KELVIN	FLICKER SPEED			
POLICE	2	LOOP SPEED	COLOURS					
PULSE	3	HUE	FLASH TIME	LOOP SPEED	FADE OUT			
STROBE	4	KELVIN	FLASH TIME					
TELEVISION	5	HUE	LOOP SPEED					

NUM	LIGHTSOURCE COLOUR
01	Blue screen
02	Green screen
03	Candle
04	Tungsten
05	Halogen
06	Carbon arc
07	Fluor warm
08	Fluor standard

NUM	LIGHTSOURCE COLOUR
09	Fluor cool
10	Fluor black light
11	Hmi
12	Mercury vapor
13	Moonlight
14	Sky blue
15	Sky overcast
16	Sodium Hi pressure

NUM	LIGHTSOURCE COLOUR
17	Sodium vapor
18	Sunlight
19	Sunset sun

ETHERNET Art-Net

On the EVO Weatherproof panel, you have wireless Art-Net control through VELVET Wi-Fi.

On the EVO STUDIO panel, you have two Art-Net control options:



- Wire control through Ethernet RJ-45 connector
- Wireless control through Wi-Fi

Art-Net™ designed by and Copyright Artistic Licence Holdings Ltd is a network protocol to control devices. For more detailed information, please visit the site of the Art-Net developers www.artisticlicence.com.

SETTINGS

To see Ethernet settings on the EVO STUDIO panel:

Push  button to select "SETTINGS"

Select "REMOTE CONTROL" with   and press 

Select "ETHERNET" with   and press 

FUNCTIONS

The Ethernet function shows the following information:

- Connection status active / waiting
- IP when EVO is connected to a network it shows the fixture IP address
- MAC when EVO is connected to a network it shows the fixture MAC address

NOTE As soon as a wired signal is detected via the other interface (DMX-512A through XLR-5 connector), any wire Art-Net data will be ignored and the EVO panel will only process the DMX wired command.

The EVO panels CPU includes a highly advanced hardware with a dedicated software to offer the user full wireless control.

The EVO Weatherproof panels can be wirelessly controlled on three ways:

- DMX-RDM through LumenRadio CRMX
- Wi-Fi Art-Net to control from smart devices with VELVET GOYA App
- Bluetooth control from Smartphone or tablet with VELVET GOYA App

The EVO STUDIO panels can be wirelessly controlled through Wi-Fi Art-Net. Using a Smartphone or tablet with VELVET GOYA App you get full, intuitive control.

The EVO Weatherproof panels are equipped with a wireless DMX-RDM receiver supporting the LumenRadio CRMX protocol.

The EVO Weatherproof panels can be linked to any wireless DMX LumenRadio transmitter if there is no DMX signal received via a wired interface (DMX-512A through XLR-5 connector) and wireless DMX is activated via the fixture menu.

LumenRadio exclusively on EVO Weatherproof

ACTIVATING DMX LumenRadio RECEIVER

Push to select "SETTINGS"

Select "REMOTE CONTROL" with and press

Select "LUMEN RADIO" with and press

The word "ENABLE" will be visible, press to select "ON".

The fixture can now be detected by a wireless DMX Lumen Radio transmitter

Once Lumen Radio is activated the color display will show the following information:

- Connection status active / waiting
- Quality 0 to 100 signal strength
- State linked / free
- DMX
- Enable on/off

DISACTIVATING DMX LumenRadio RECEIVER

Push to select "SETTINGS"

Select "WIRELESS CONTROL" with and press

Select "LUMEN RADIO" with and press



The word "ENABLE" will be visible, press to select "OFF"

LINKING EVO FROM WIRELESS DMX LumenRadio TRANSMITTER

To link the EVO you only need to activate the LumenRadio on the EVO and then follow the transmitter instructions (normally you only need to briefly push a button on the transmitter and wait around 5 seconds until a visible light will stop blinking on the transmitter).

UNLINKING FROM WIRELESS DMX LumenRadio TRANSMITTER

Push  to select "SETTINGS"

Select "REMOTE CONTROL" with   and press 

Select "LUMEN RADIO" with   and press 
The word "UNLINK" will be visible (only if the EVO was previously linked).

Press  to unlink

NOTE As soon as a wired signal is detected via the other interface (DMX-512A through XLR-5 connector), any wireless DMX-RDM data will be ignored and the EVO panel will only process the wired DMX signal.

Every EVO fixture is equipped with a Wi-Fi Art-Net system to wirelessly control the panel.

Art-Net™ Designed by and Copyright Artistic Licence Holdings Ltd is a network protocol to control devices. For more detailed information, please visit the site of the Art-Net developers www.artisticlicence.com.

WI-FI Art-Net

To link the EVO panel with any Wi-Fi device like smartphone, tablet or computer it is mandatory to use a VELVET Router (ref. VE-ROUTER) or alternatively any Wi-Fi router in which you need to change the SSID and password to make it compatible with EVO.

The EVO can be linked to any Wi-Fi device through the Wi-Fi Router if there is no DMX signal received via a wired interface (DMX-512A through XLR-5 connector or Art-Net through Ethernet connector) or via wireless DMX LumenRadio and Wi-Fi is activated via the fixture menu.

If you want to use your own router you need to configure it with these credentials:

SSID: VELVET Router

Password: velvetrouter

ACTIVATING WI-FI

Push to select "SETTINGS"

Select "REMOTE CONTROL" with and press

Select "WIFI" with The word "CONNECT" will be visible

Press The fixture can now be detected by a wireless DMX Lumen Radio transmitter

Once Wi-Fi is activated the color display will show the following information:

- Connection status active / waiting
- IP address
- MAC
- RSSI
- Connect / disconnect

DISACTIVATING WI-FI

Push to select "SETTINGS"

Select "REMOTE CONTROL" with and press

Select "Wi-Fi" with Push to deactivate.

NOTE As soon as a wired signal is detected via the other interfaces (DMX-512A through XLR-5 connector or Art-Net through Ethernet connector), or a wireless DMX LumenRadio signal is detected any Wi-Fi data will be ignored and the EVO panel only processes the wired DMX/RDM signal or the wireless DMX LumenRadio signal.



BLUETOOTH

Every EVO fixture is equipped with a Bluetooth system to wirelessly control the panel.

The EVO can be linked to any Bluetooth device if there is no DMX signal received via a wired interface (DMX-512A through XLR-5 connector or Art-Net through Ethernet connector) or via wireless DMX LumenRadio and Bluetooth is activated via the fixture menu.

ACTIVATING BLUETOOTH

Push  to select "SETTINGS"

Select "REMOTE CONTROL" with   and press 

Select "BLUETOOTH" with  

The word "DISCONNECTED" will be visible together with a big red rectangle.

The fixture can now be detected by any Bluetooth device.

Once the EVO will be connected to any device the word "CONNECTED" will be visible and the big rectangle will turn into green.

DISACTIVATING BLUETOOTH

Push  to exit from the Bluetooth screen and the EVO will no longer react to Bluetooth commands.

To disconnect from any Bluetooth device:

Once into the Bluetooth screen push 

The word "DISCONNECTED" will be visible together with a big red rectangle.

NOTE As soon as a wired signal is detected via the other interfaces (DMX-512A through XLR-5 connector or Art-Net through Ethernet connector), or a wireless DMX LumenRadio signal is detected any Bluetooth command will be ignored and the EVO panel only processes the wired DMX/RDM signal or the wireless DMX LumenRadio signal.

VELVET GOYA APP

lets you remotely control any EVO from any smartphone or tablet (Android or iOS) through two compatible ways:

- **Wi-Fi**
Control unlimited number of fixtures up to 100 meters / 330 feet distance through a VELVET Router (sold separately).
- **BLUETOOTH**
Directly control up to 4 fixtures from up to 30 meters / 100 feet distance
The App automatically discovers any available EVO fixture and offers full control with its attractive and intuitive interface.

CONTROL OPTIONS VELVET Goya offers two control options:

- **SINGLE CONTROL**
Quick and easy interface to control single EVO fixtures, create and save your own white light, color setting or gels.
- **PROJECTS**
Advanced control to create off-line or on-line lighting projects and scenes using unlimited number of EVO fixtures.

CONTROL MODES You can easily adjust, create and save your white or color light in several intuitive modes:

- **CTT**
Intensity/ Kelvin 2500K-10,000K/ Green-Magenta
- **HSI+**
Hue color wheel/ Saturation/ Intensity over any white base from 2500K-10,000K
- **RGB+**
RED / GREEN / BLUE / WHITE / COLD WHITE / Intensity master
- **GELS**
A wide catalog of Gels / Light Sources and Presets to save your own gels created from any of the modes.

Using PROJECTS you can work both on-line or off-line to easily create your light designs and scenes. You can group light fixtures, display and move them over your set, rename them or add new lights. You will immediately identify the EVO models by their shape while their actual color will always be visible.

CONNECTING THROUGH WI-FI

To link the EVO panel with any Wi-Fi device like smartphone, tablet or computer it is mandatory to use a VELVET automatic Router (ref. VE-ROUTER) or alternatively any Wi-Fi router in which you need to change the SSID and password to make them compatible with EVO.

To link EVO with VELVET Goya App:

- Place the VELVET Router on a stable surface, clear of obstructions. It is recommended to place the device elevated above nearby objects and people to minimize physical interference.
- Power on the VELVET Router through the 12V DC power supply. A blue indicator will light on.
- Wait around 30 seconds until the blue Wi-fi indicator get solid.
- Power on EVO and activate its Wi-Fi function.
- Power on your smartphone or tablet.
- Select the Wi-Fi network named "VELVET Router"
- Enter the PASSWORD "velvetrouter"
- If your smartphone or tablet shows a message warning you have not internet access then select "No internet"
- Open VELVET Goya App, select either SINGLE CONTROL or PROJECTS and push the Wi-Fi icon to discover the available EVO fixtures.

CONNECTING THROUGH BLUETOOTH

- Power on EVO and activate its BLUETOOTH function.
- Power on your smartphone or tablet.
- Enable your Smartphone or tablet Bluetooth.
- Open VELVET Goya App, select either SINGLE CONTROL or PROJECTS and push the BLUETOOTH icon to discover the available EVO fixtures

IMPORTANT NOTE: to avoid interferences you must disconnect any third smartphones, tablets or computers from the VELVET Router while using VELVET Goya App.

DISPLAY BRIGHTNESS

You can set the color display brightness

Push button to select "SETTINGS"

Select "DISPLAY" with and press

On the DISPLAY sub-menu select "BRIGHTNESS" with and press

to set the brightness level

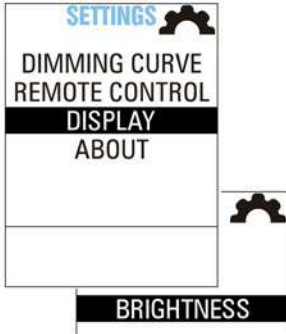

FACTORY PRESET

About shows fixture model, fixture serial number, firmware version, calibration date, RDM ID, Ethernet ID MAC and fixture temperature.

Push to select "SETTINGS". Select "ABOUT" using and press

On the sub-menu select "FACTORY PRESET" using and press

Press to apply factory preset.

FIRMWARE UPDATE

- Copy the EVO update file to the root of an USB memory stick
- Power ON the EVO
- Connect the USB memory stick to the mini-USB connector of the EVO panel through a mini-USB male to USB female adaptor.

Push to select "SETTINGS" and select "ABOUT" with

Press and select "FIRMWARE UPDATE". Press to start the process.

- Once the firmware update process is finished the EVO panel will reboot with the new firmware.

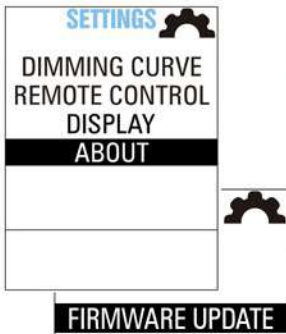

USB FUNCTIONS

You can create and save your own user preset list from EVO to a USB memory stick and upload them to any EVO.

Push to select "SETTINGS". Select "ABOUT" using and press

On the sub-menu select "USB FUNCTIONS" using and press

Connect the USB memory stick to the mini-USB connector of the EVO panel through a mini-USB male to USB female adaptor.

Press . The screen will show these two options:

- "LOAD PRESETS FROM USB"
- "SAVE PRESETS TO USB"

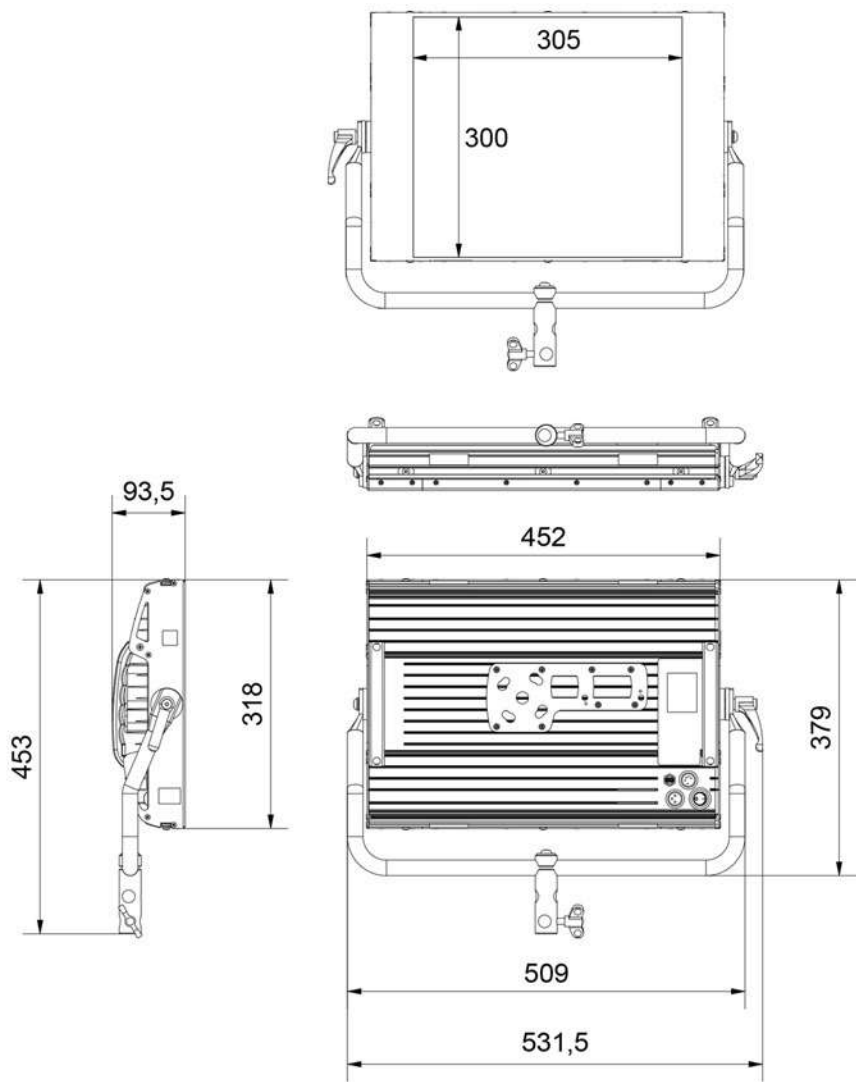

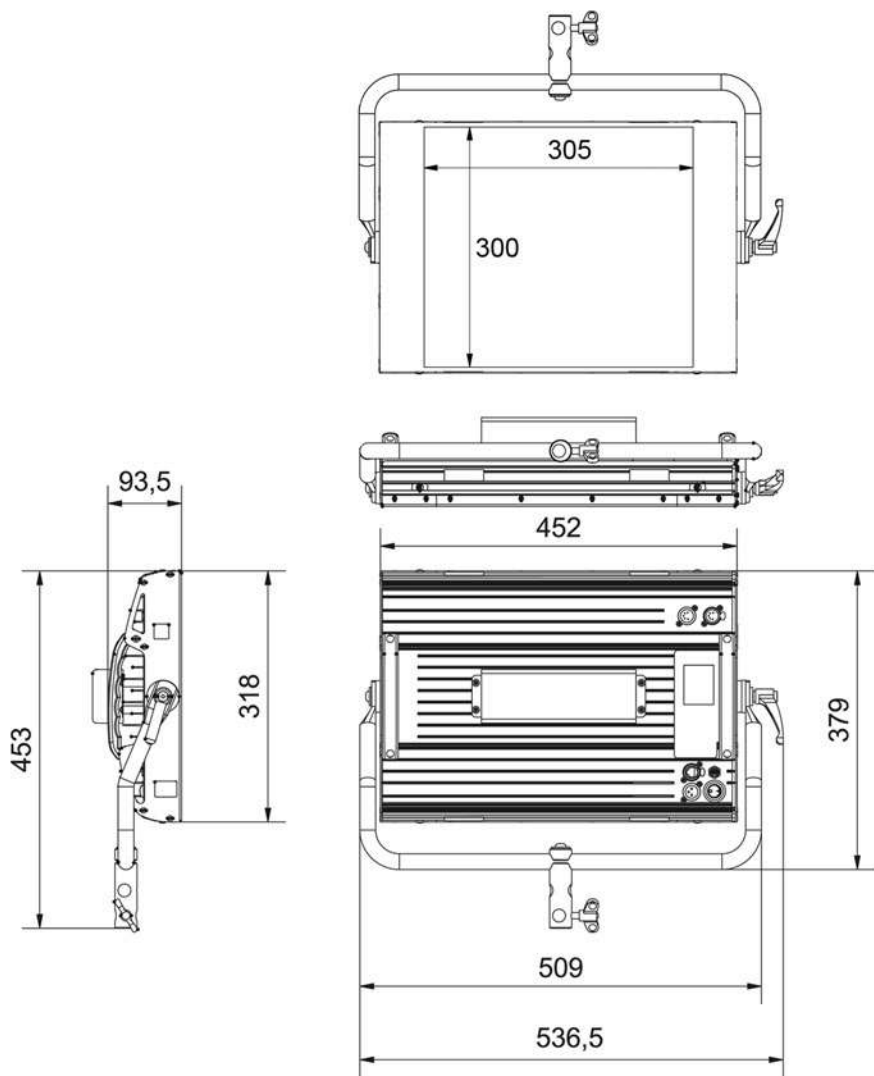

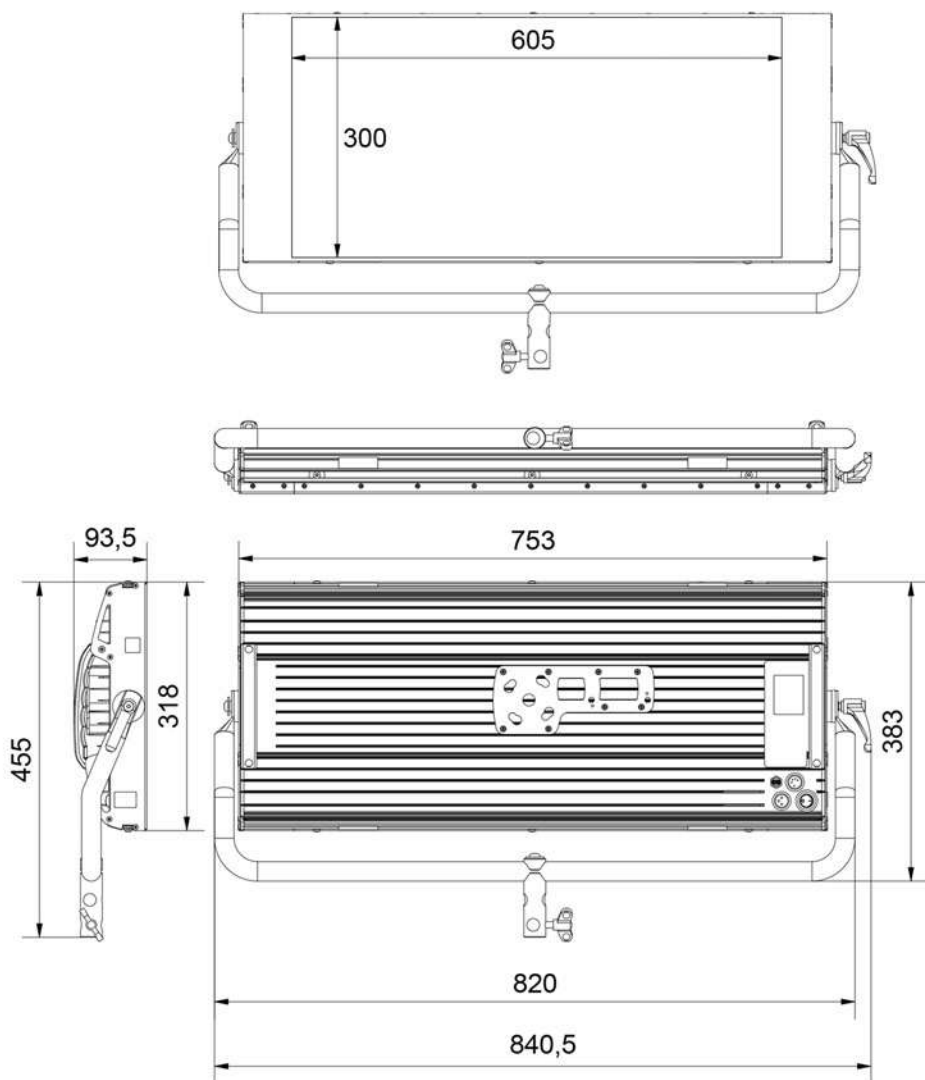

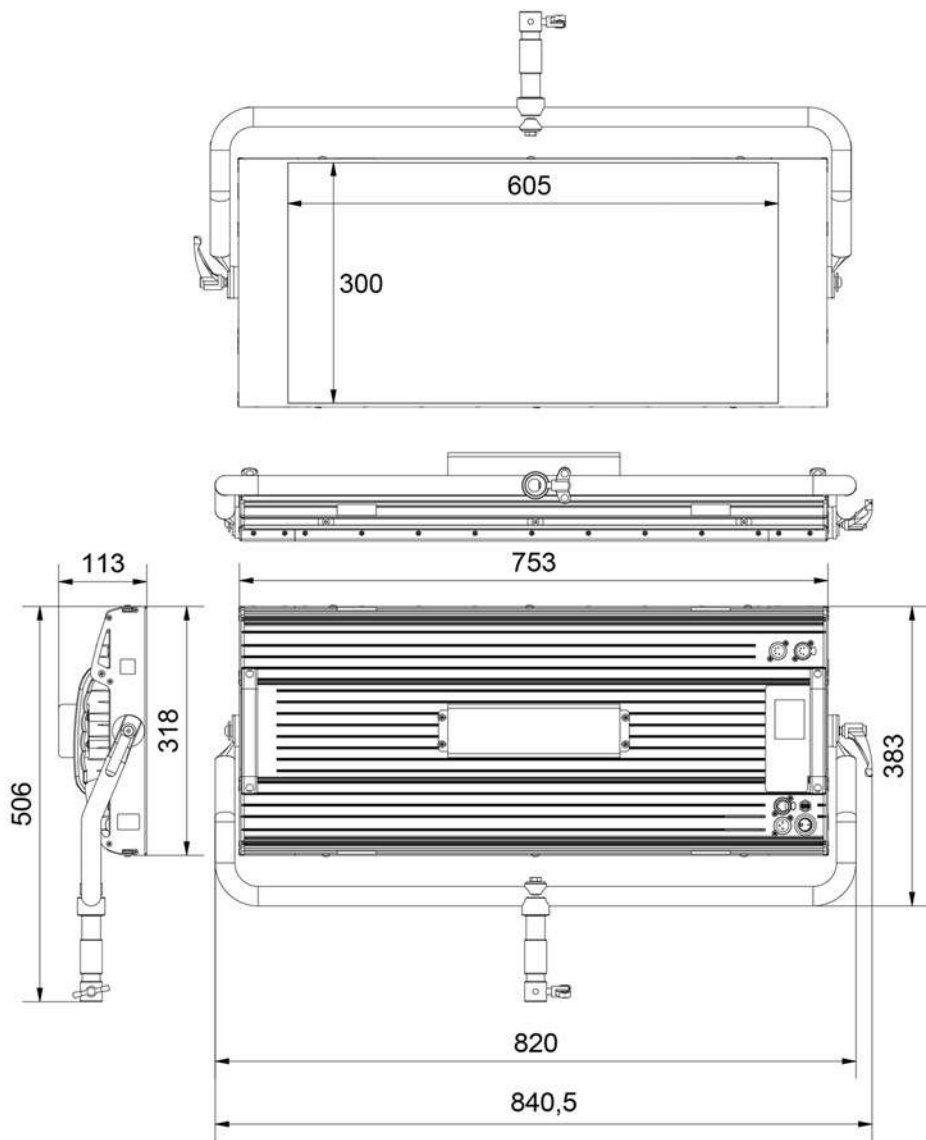

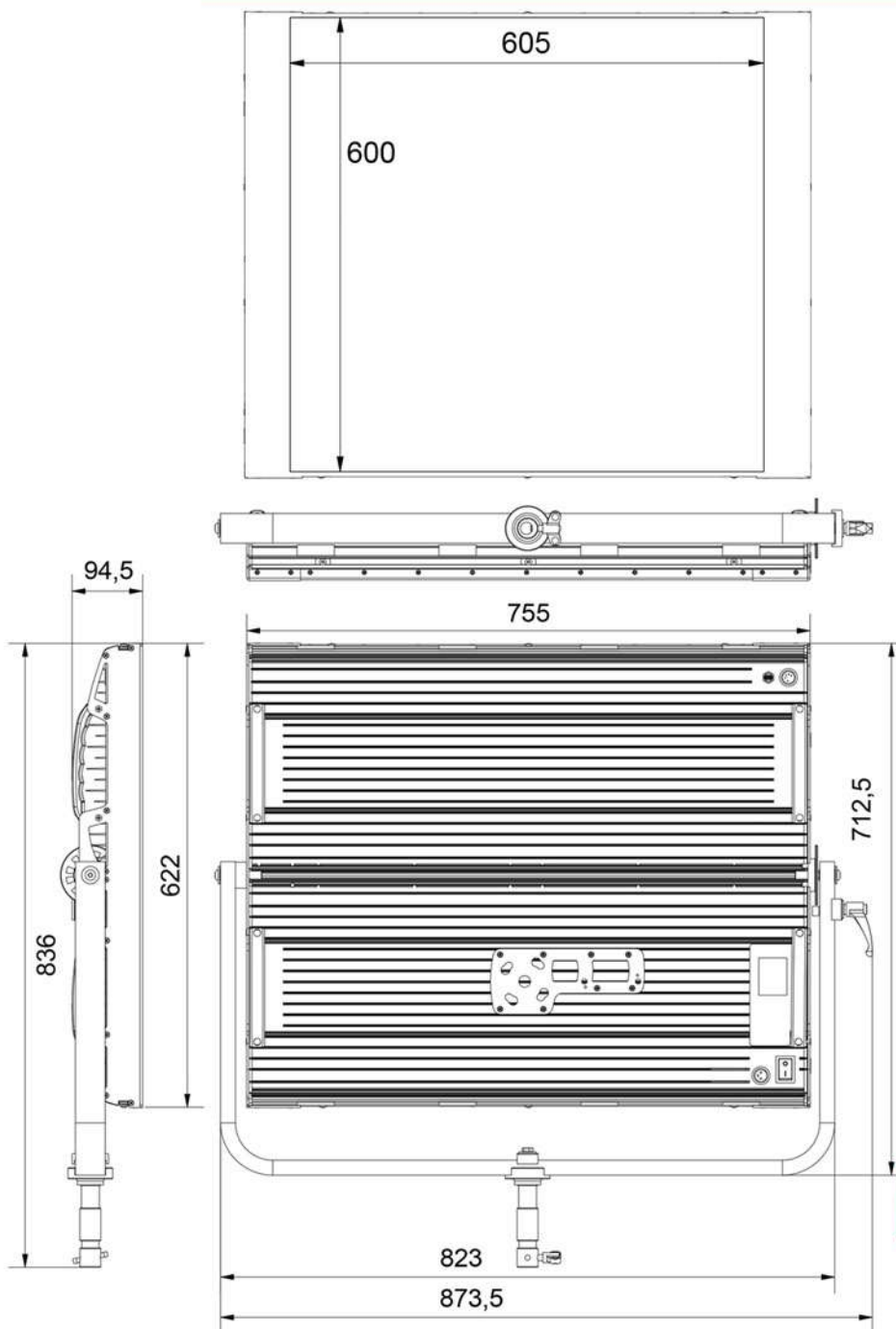

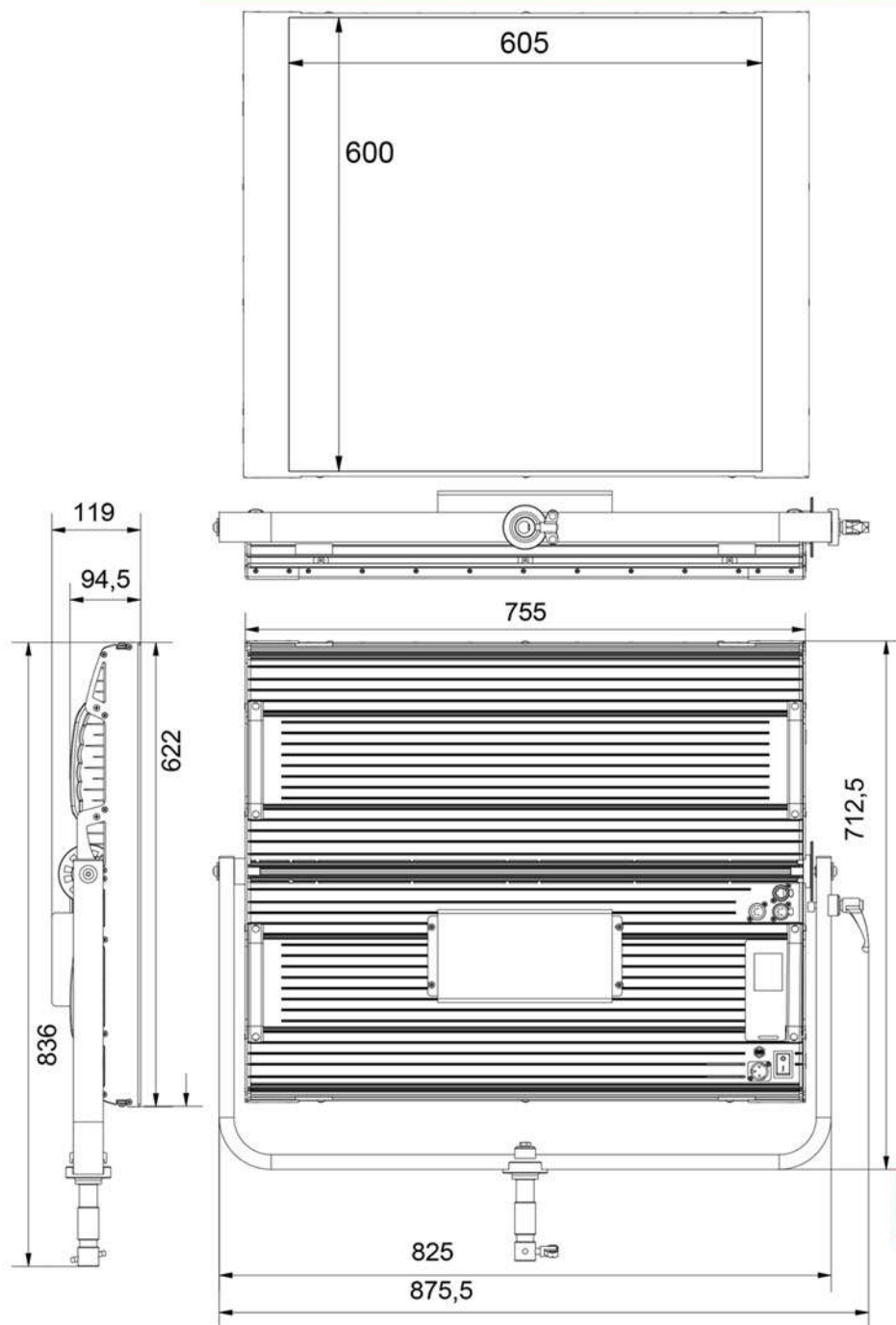

Brand Name: VELVET

Product Description: LED Luminaire systems for professional use
EVO 1, EVO 1 Studio, EVO 2, EVO 2 Studio, EVO 2x2, EVO 2x2 Studio

The above products abide by the following European Directives:

DIRECTIVES

2014/30/EU of the European Parliament and of the Council of 26 February 2014 on the harmonization of the laws of the Member States relating to electromagnetic compatibility.

2014/35/EU of the European Parliament and of the Council of 26 February 2014 on the harmonization of the laws of the Member States relating to the making available on the market of electrical equipment designed for use within certain voltage limits.

2001/95/EC of the European Parliament and the Council of 3 December 2001 on general product safety

2011/65/EU of the European Parliament and of the Council of 8 June 2011 on the restriction of the use of certain hazardous substances in electrical and electronic equipment.

STANDARDS

In compliance with the harmonized standards:

IEC 60598-1:2014 Luminaires – Part 1: General requirements and tests
IEC 60598-1-17:2017 Luminaires – Part 2-17: Particular requirements – Luminaires for stage lighting, television and film studios (outdoor and indoor)
IEC 62031:2008/A1:2012 LED modules for general lighting - Safety specifications
IEC 61547:2009 Equipment for general lighting purposes - EMC immunity requirements
IEC 61000-6-1:2005 Electromagnetic compatibility (EMC) -- Part 6-1: Generic standards - Immunity for residential, commercial and light-industrial environments
IEC 61000-6-3:2006/A1:2010 Electromagnetic compatibility (EMC) - Part 6-3: Generic standards - Emission standard for residential, commercial and light-industrial environments
IEC 61000-6-4:2006/A1:2010 Electromagnetic compatibility (EMC) -- Part 6-4: Generic standards - Emission standard for industrial environments

EN 301489-1 V1.8.1 Electromagnetic compatibility and Radio spectrum Matters (ERM); Electromagnetic Compatibility (EMC) standard for radio equipment and services; Part 1: Common technical requirements

IEC 62493:2009 Assessment of lighting equipment related to human exposure to electromagnetic fields

EN 55015:2013 Limits and methods of measurement of radio disturbance characteristics of electrical lighting and similar equipment

EN 62471:2008 Photobiological Safety of Lamps and Lamp Systems



Barberà del Vallès, 10th February 2019
Authorised Administrator - Javier Fdez. de Valderrama

WARRANTY

VELVET LED light fixtures are guaranteed to be free from defects in workmanship and parts in a warranty period of two (2) years from the date of purchase. Defects that occur within this warranty period, under normal use and care will be repaired or replaced at VELVET discretion, solely at our option with no charge for parts or labour. In the event of the equipment malfunction, contact the dealer from which you purchased the product. Please note that you will be not be reimbursed for the cost of bringing the equipment to the VELVET Repair Centre.

VELVET reserves the right to replace the product or relevant part with the same or equivalent product or part, rather than repair it. Where a replacement is provided the products or part replaced becomes the property of VELVET. VELVET may replace parts with refurbished parts. Replacement of the product or a part does not extend or restart the Warranty period.

RETURNS POLICY

Returns or exchanges from the customers will be accepted within 15 days of delivery and will not include the actual shipping costs. Item(s) must be in original packaging and condition, must not be assembled, and must include its original user manual.

This warranty does not cover any damage resulting from:

- Failure to follow the instructions in the instruction manual Repair, modification or overhaul not conducted by any authorized VELVET personnel.
- Fire, natural disaster, act of God, lightning, abnormal voltage, etc;
- Submergence in water (flooding), exposure to alcohol or other beverages, infiltration of sand or mud, physical shock, or dropping of the equipment and other unnatural causes.

This warranty only applies to the LED panel and not to the accessories, such as barn doors or mounts.

Any consequential damages arising from failure of the equipment, such as expenses incurred in taking pictures or recording images or loss of expected profit, will not be reimbursed whether they occur during the warranty period or not.

Parts essential to the servicing of the light equipment (that is, components required to maintain the functions and quality of the fixture) will be available for a period of five years after the product is discontinued.

velvetlight.tv



VELVET

made to last

2020. Copyright VELVETLight. All rights reserved