

VELVET Power 1 Studio 30° IP51



Ref.: VP1ST

Datasheet: June 2021 / Page 1

Bicolor dustproof, IP51 AC powered concentrated long distance beam light LED panels

[Click here for more product information](#)

VP1ST includes: 1x VELVET Power1 flood 30° LED dustproof panel IP51, 1x yoke with 28mm junior pin-16mm baby receiver, 1x 3,5mts power cable with aerial PowerCon TRUE1



1. Power switch
2. XLR-3 DC In
3. XLR-5 DMX In
4. +/- Adjustment buttons
5. 3200K/ 5600K Quick access button
6. Mode selection button (Dimmer/ Colour)
7. Digital display
8. XLR-5 DMX Out



VELVET Power 1 Studio 30° IP51



Ref.: VP1ST

Datasheet: June 2021 / Page 2

COLOUR TEMPERATURE	adjustable from 2700K to 6500K in 100K steps
LIGHT INTENSITY	dimnable 0 to 100, smooth and flicker-free
TLCI	98 at 3200K and 97 at 5600K
DIMENSIONS	380x308x68mm / 15"x12"x2.7" panel 495x395x68mm / 19.5"x15.5"x2.7" panel + yoke
WEIGHT	4.2kgs / 9 lbs panel 4.7kgs / 10 lbs panel + yoke
POWER DRAW	100W
POWER SUPPLY	90-264V AC 50/60Hz through XLR3 connector
PHOTOMETRICS	14000 lux / 1296 fc at 1m / 3 feet 2000 lux / 185 fc at 3m / 10 feet 550 lux / 51 fc at 6m / 20 feet
BEAM ANGLE	30° nominal with filter D25 45° D50 60° D100 105° DVELVET 115°
LED RATED LIFE	more than 50,000 hours
OUTPUT FREQUENCY	16KHz flicker-free up to 2000fps
COOLING	no-noise, fan-free passive cooling
PROTECTION	IP51 dustproof, indoor or outdoor protected use
CONSTRUCTION & FINISH	Made of black powdercoated extruded and sheet aluminum
VELVET LED TECHNOLOGY	selected BIN high-power LED + VELVET custom optics + CPU software control
ACCESSORIES	Quarter, half and full hard diffusion, foldable Snapbag diffuser kit, foldable 20°, 40° or 60° Snapgrids, removable barndoors, AC power adapter, remote control, Cordura carrying bag, hard case.
RIGGING OPTIONS	aluminum yoke with 16 baby receiver combined with 28 junior pin, multiple ¼-20" rigging points, multipanels yokes, pole-operated studio yoke

WIRE VIEW

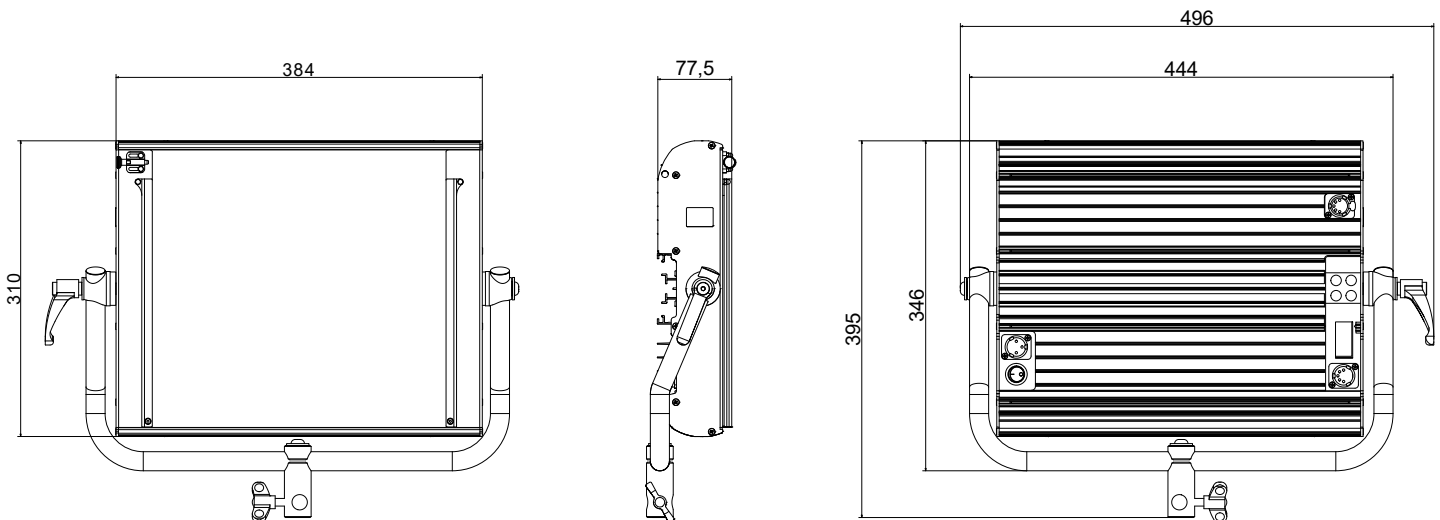

VELVET Power 1 Studio 30° IP51



Ref.: VP1ST

Datasheet: June 2021 / Page 3

PHOTOMETRICS

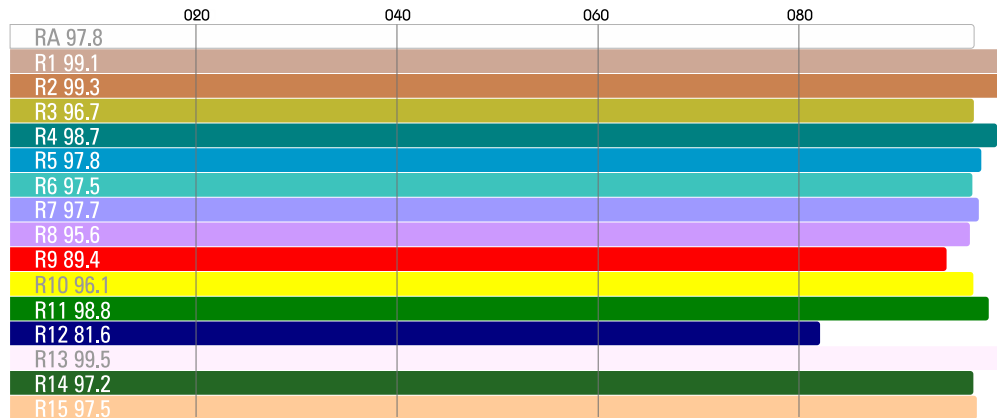
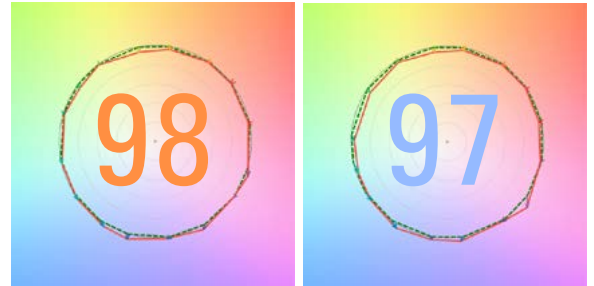
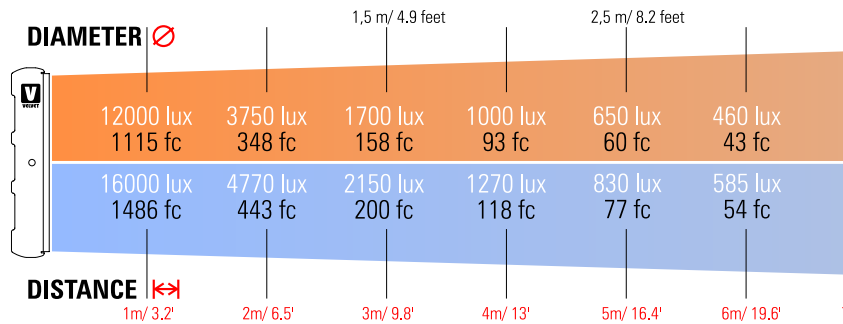

CCT 3220K

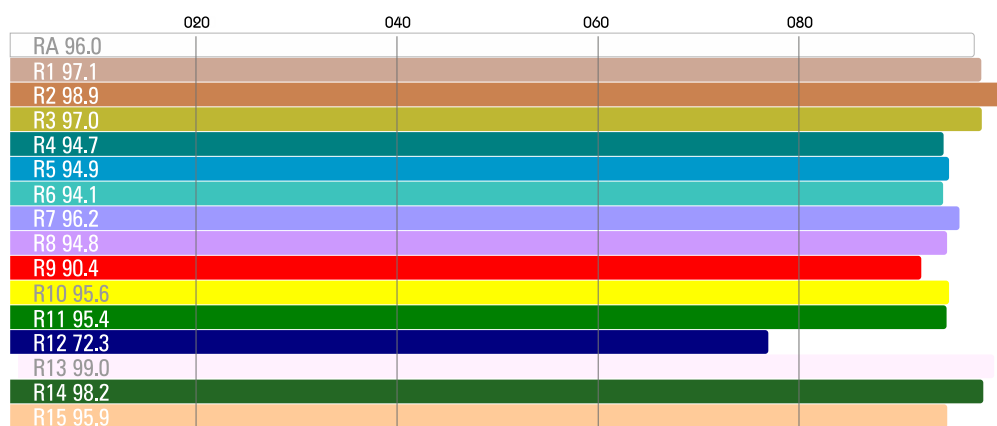

CCT 5440K

VELVET Power 1 Studio 30° IP51



Ref.: VP1ST

Datasheet: June 2021 / Page 4

ACCESSORIES

POWER SUPPLY



VL1ST-PSU

RIGGING



VL1-YPO

BEAM CONTROL



VL1-RB

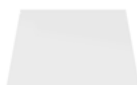

VP1-D25

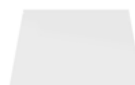

VP1-D50



VP1-D100



VP1-DVL



VP1-FBAG



VL1-SG



VL1-SB



VL1-SGXSB



1X1-RABBITSQ



OCTA-SBR03

TRANSPORT



VL1-BAG



VL1-DBAG



VL1-TBAG



VL1-CASE