



VELVET Power 1/2

SERIES USER MANUAL

velvetlight.tv

This guide provides information about how to use the product functions to illuminate with this equipment as well as warnings on his use.

These are products of professional use for exterior and interior locations or studio and must be operated only by qualified technical personnel.

To obtain the maximum features, please read the following operating instructions very carefully before using this fixture for the first time. Please keep these operating instructions for you and subsequent users to reference in the future.

THELIGHT Luminary for cine and TV, S.L.

- | | |
|---------------------------------|---|
| SAFETY PRECAUTIONS | For your own safety, please read and follow all safety instructions and warnings. |
| EXEMPTION FROM Liability | THELIGHT Luminary for cinema and TV, S.L. does not assume any responsibility for lighting failures caused by malfunction of this product. The manufacturer disclaims liability for any damage to persons or property caused by inappropriate operation, damage of this kind lies in the responsibility of the operator. |
| WARRANTY | This product is manufactured to local specifications and the warranty is valid within the country of purchase. Should the product fail or malfunction while you are abroad, the manufacturer assumes no responsibility for servicing the product locally or bearing the expenditure incurred thereof. |

www.velvetlight.tv

The total or partial reproduction of this guide is prohibited without the express written permission of VELVET.
VELVET technology is protected under Spanish license laws with international patents pending.
Information and specifications in this document are subject to change without notice.

2017 © Copyright VELVET. All rights reserved.

Various symbols are used throughout this instruction manual and on the product to prevent physical harm to you or other people and damage to property.

The symbols and their meanings are explained below.



Possible risk of injury or damage to equipment

Do not attempt to open any of the device or component housings. To reduce the risk of electric shock, do not remove LED panel side covers or front plastic diffuser. No user-serviceable parts inside. Maintenance and repair work to be carried out only by VELVET Service Centre.

Do not cover the aluminium lamp head heat sink while using it. Proper ventilation must be provided. Avoid exposing the lamp head to the heat radiation of other light fixtures.

The lamp head is equipped with mid power LED. Due to their high light-output intensity don't stare directly into the light source



This symbol indicates the risk of electric shock or fire danger that could result in injury or damage to equipment.

In order to protect against risk of electric shock, the installation should be properly grounded. Defeating the purpose of the grounding type plug will expose you to the risk of electric shock.



This equipment has been checked and meets the requirements of general safety for electronic devices. These requirements are specified to provide a reasonable protection against electromagnetic interferences when the equipment is used in commercial environments.

This equipment generates, uses and can emit waves of radio frequency, and if not properly used following the instructions of this manual can produce interferences in radio communications. The use of this equipment in residential areas can produce interference, the user will be the only responsible of correcting them.



Though the light generated by LED does not produce any heat, for what his use turns out to be very comfortable for the actors, the lamp head acts as a heat sink through its back part.

Surface can reach a temperature between the 20 °C and the 60 °C. Please use protective gloves if you touch the lamp head at the heat sink.

06	MAIN FEATURES
07	MODELS
08	ACCESSORIES/ POWER OPTIONS
11	ACCESORIES/ BEAM CONTROL & DMX CONTROL
14	ACCESORIES/ BAGS & CASES
15	VELVET Power 1 SPECIFICATIONS & PARTS POWER OPTIONS
18	VELVET Power 1 STUDIO SPECIFICATIONS & PARTS POWER OPTIONS
20	VELVET Power 2 SPECIFICATIONS & PARTS POWER OPTIONS
23	VELVET Power 2 STUDIO SPECIFICATIONS & PARTS POWER OPTIONS
25	PLACING INTO OPERATION YOKE TO LED PANEL ASSEMBLING VELVET Light 1 & 2 MOUNTING OPTIONS, SECURITY CABLES
27	DIGITAL ADJUSTMENTS/ COLOR & DIMMING
28	DIGITAL ADJUSTMENTS/ MASTER & SLAVE
29	DIGITAL ADJUSTMENTS/ DMX RDM FUNCTIONS
30	ACCESSORIES INSTALLATION/ SNAPGRID, SNAPBAG & HEXAGONAL SPUD
31	CHROMACITY COORDINATES DIAGRAM
32	REGULATIONS
33	DIAGRAMS VELVET Power SERIES 1 & 2 Flood/ Spot LOCATION
34	DIAGRAMS VELVET Power SERIES 1 & 2 Flood/ Spot STUDIO
35	WARRANTY

VELVET Power 1 / 2 LOCATION

RAINPROOF IP-54/DMX x 1 XLR-5

VELVET Power 1 / 2 STUDIO

DUSTPROOF IP-51/DMX x 2 XLR-5

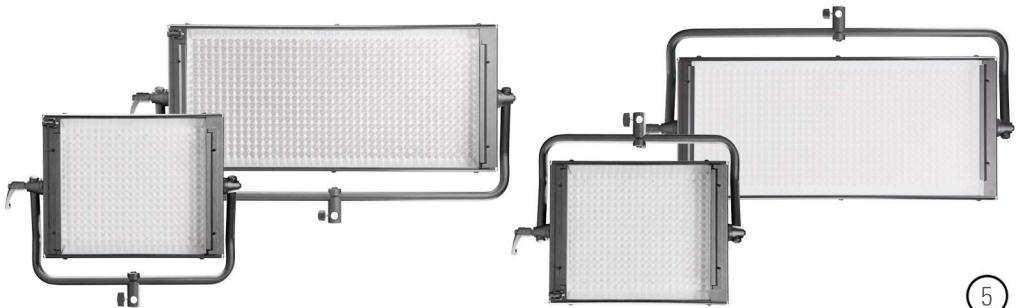



VELVET Power series are LED panels produce concentrated light using high-power LED. They had been specially designed and their colorimetry calibrated for professional photography, cinematography and television industry use.

- Rainproof robust aluminum construction
- Variable Color Temperature from 2700K to 6500K
- Dedicated quick-access button 32K / 56K
- High-power LED 50,000 hours life
- +95 CRI digitally calibrated light
- Professional and consistent color rendition
- Digital control and through DMX RDM
- Silent fan-free operation
- Flicker free over 1000 fps
- Concentrated light
- Smooth dimming with no color shift

NOTE ABOUT MEASURING COLOUR TEMPERATURE (CCT)

VELVET Power incorporate the innovative THELIGHT technology based on Osram mid power LED precise bin selection + optical diffuser + CPU control software to obtain the wide range of calibrated colour temperatures combined with a high color rendering index CCT.

We must remark that traditional color meters still in use today are designed for a full spectrum source such as incandescent lights and therefore cannot be used to accurately read the correlated color temperature (CCT) of the light emitted by VELVET and other LED light fixtures.

The eventual diversions to green display as CC05M or CC10M in hand-held color meters are due to these unaccuracy on reading of the light emitted by LED and must not be considered.

To precisely measure the light emitted by VELVET and other LED light fixtures a spectrometer specially calibrated for LED sources must be used.

VELVET guarantees pure white light with no green deviation and correct colorimetry of the light delivered by its LED luminaries which have been calibrated in laboratory according to CIE 13.3-1995 international standards for measurement of the CRI and chromatic coordinates (x, and CIE-1931).

The reliability of this digital equipment is supported by the calibration VELVET has made in laboratory by spectrophotometer, which precision is half-yearly calibrated according to the National Institute of Standards (NIST) of the United States and of the Physikalisch-Technische Bundesanstalt (PTB) of Germany.

In order that the advanced VELVET luminaries could be used together with other light sources, VELVET has accurately calibrated both the CCT and the chromatic coordinates to match them with traditional light sources following tungsten and daylight standards.

Square 1x1 foot (30 x 30 cms) and rectangular 2x1 feet (60 x 30 cms) rainproof LED panels made of aluminum housing high CRI selected BIN high-power LED.

Every VELVET Power LED panel includes a digital control on board. The range of VELVET Power 1 and 2 products is composed by:

VELVET Power 1

FLOOD 30° BEAM. RAINPROOF IP54
Ref VL1-IP54-Power-FLOOD

SPOT 15° BEAM. RAINPROOF IP54
Ref VL1-IP54-Power-SPOT

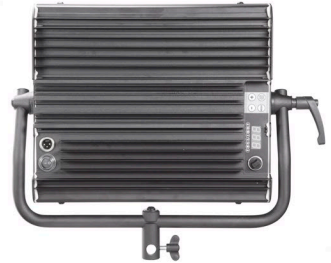

VELVET Power 1 STUDIO

FLOOD 30° BEAM. DUSTPROOF IP51
Ref VL1-Power-STUDIO

SPOT 15° BEAM. DUSTPROOF IP51
Ref VL1-Power-STUDIO-SPOT



VELVET Power 2

FLOOD 30° BEAM. RAINPROOF IP54
Ref VL2-IP54-Power-FLOOD

SPOT 15° BEAM. RAINPROOF IP54
Ref VL2-IP54-Power-SPOT

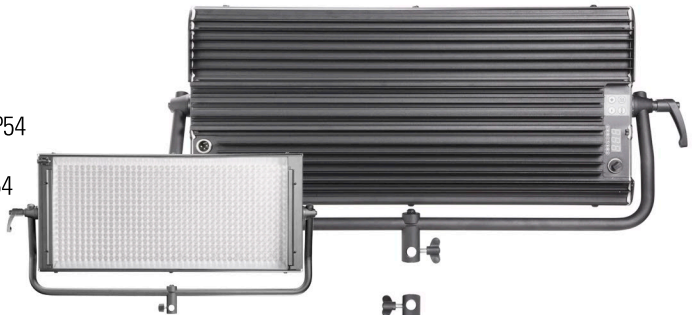

VELVET Power 2 STUDIO

FLOOD 30° BEAM. DUSTPROOF IP51
Ref VL2-Power-STUDIO

SPOT 15° BEAM. DUSTPROOF IP51
Ref VL2-Power-STUDIO-SPOT

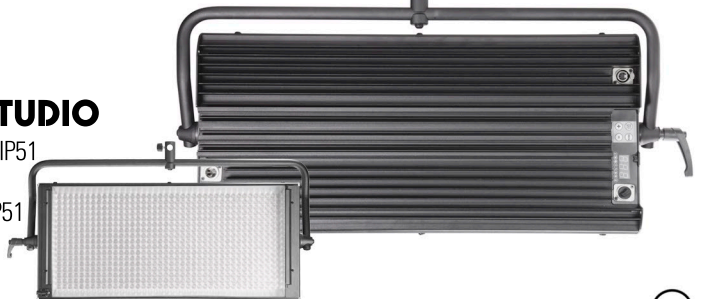

VELVET Power 1

FLOOD/SPOT LOCATION

120W AC power adapter with XLR3 connector + quick mount + power cable + hexagonal spud
Ref. VL-PSU-120W

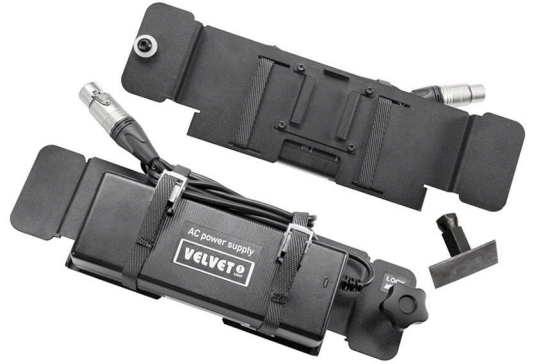

VELVET Power 1

FLOOD/SPOT STUDIO

120W STUDIO AC power adapter with XLR3 connector + quick mount + power cable with PowerCon connector
Ref. VL1-PSU-STUDIO



VELVET Power 2

FLOOD/SPOT LOCATION & STUDIO

320W AC power 2 power supply XLR3 connector + quick mount + power cable with PowerCon TRUE 1 connector
Ref. VL2-POWER-PSU



VELVET Power 1
FLOOD/SPOT LOCATION

Vlock battery mount with XLR-3 connector
on quick link plate + Spud
Ref VL1-Vlock



VELVET Power 1
FLOOD/SPOT LOCATION

Gold battery mount with XLR-3 connector
on quick link plate + Spud
Ref VL1-Gold



VELVET Power 2
FLOOD/SPOT LOCATION

Vlock battery mount 2x with XLR-3 connector
+ Spud
Ref VL2-Vlock



VELVET Power 2
FLOOD/SPOT LOCATION

Gold battery mount 2x with XLR-3 connector
+ Spud
Ref VL2-Gold



VELVET Panels

4,5 m XLR-3 DC power
extension cable
Ref DCC4.5-XLR3



VELVET Power 1/2
FLOOD/SPOT LOCATION

DMX Aerial splitter IN/OUT
Ref THE-VL-DMXinout



VELVET Power 1/2
FLOOD/SPOT SERIES

VELVET 2 center ball head with
16mm baby receiver
Ref. VL2-QLS

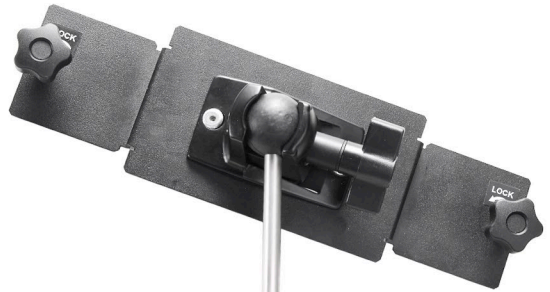

VELVET Power 1/2
FLOOD/SPOT SERIES

Pole Operated Yoke
Ref VL1-Power-Y-Poleop (VELVET Power 1)
Ref VL2-Power-Y-Poleop (VELVET Power 2)



VELVET Power 1
FLOOD/SPOT SERIES

Removable Barndoors
Ref VL1-RB



VELVET Power 2
FLOOD/SPOT SERIES

Removable Barndoors
Ref VL2-RB



VELVET Power 1
FLOOD/SPOT SERIES

Foldable Snapgrid 40°
Ref VL1-SGrid



VELVET Power 2
FLOOD/SPOT SERIES

Foldable Snapgrid 40°
Ref VL2-SGrid

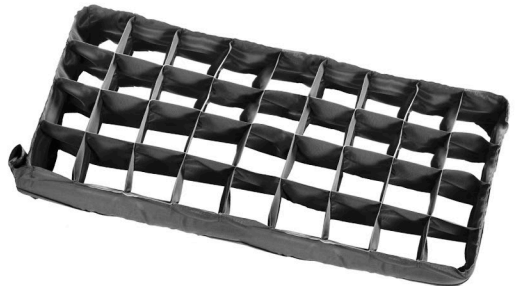

VELVET Power 1
FLOOD/SPOT SERIES

Foldable Snapbag Softbox
Includes transport Bag and 2 Baffles
Ref VL1-Power-Sbag



VELVET Power 2
FLOOD/SPOT SERIES

Foldable Snapbag Softbox
Includes transport Bag and 2 Baffles
Ref VL2-Power-Sbag



VELVET Power 1
FLOOD/SPOT SERIES

Optic diffusers
Density FULL Ref VL1-Power-D100
1/2 Ref VL1-Power-D50
1/4 Ref VL1-Power-D25

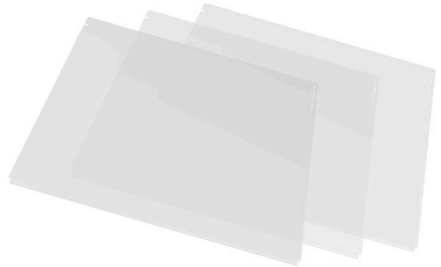

VELVET Power 2
FLOOD/SPOT SERIES

Optic diffusers
Density FULL Ref VL2-Power-D100
1/2 Ref VL2-Power-D50
1/4 Ref VL2-Power-D25

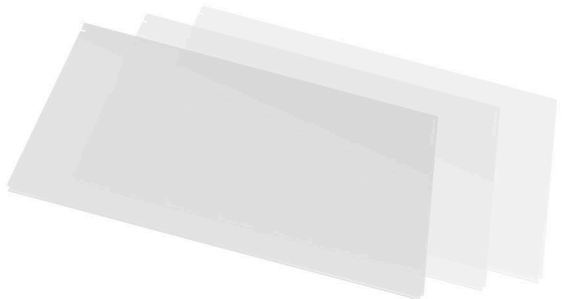

VELVET Power 1
SERIES

Semi rigid Cordura carrying bag for
1x VELVET Light 1/ Power 1 kit
Ref VL1-Bag



VELVET Power 1
SERIES

Semi rigid Cordura carrying bag for
2x VELVET Light 1/ Power 1 kits
Ref VL1x2-Bag



VELVET Power 2
SERIES

Semi rigid Cordura carrying bag for
1x VELVET Light 2/ Power 2 kit
Ref VL2-Bag



VELVET Power 1/2
SERIES

Hard Flight case
Ref VL1-Case
(for 1x VELVET Light 1/ Power 1 kit)
Ref VL2-Case
(for 1x VELVET Light 2/ Power 2 kit)

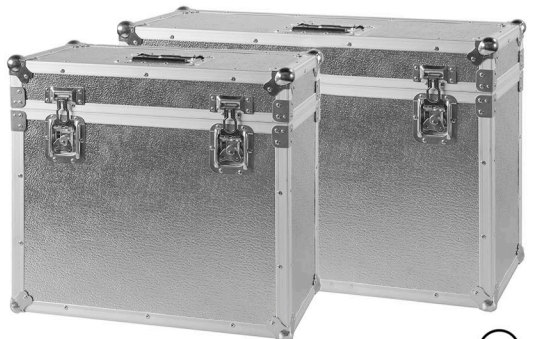

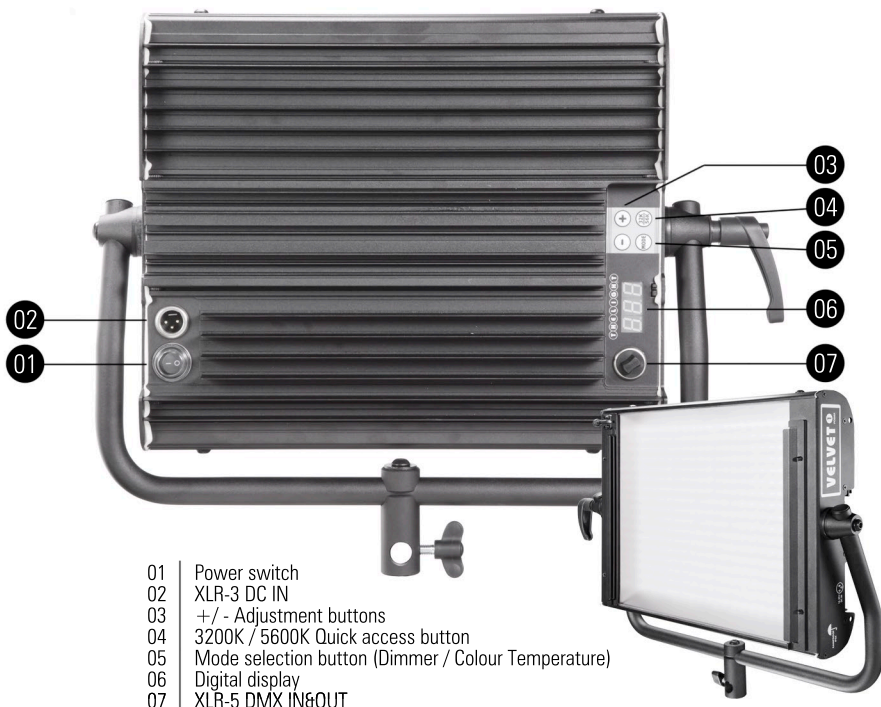

- 01 | Power switch
- 02 | XLR-3 DC IN
- 03 | +/- Adjustment buttons
- 04 | 3200K / 5600K Quick access button
- 05 | Mode selection button (Dimmer / Colour Temperature)
- 06 | Digital display
- 07 | XLR-5 DMX IN&OUT

COLOUR TEMPERATURE | Adjustable from 2700K a 6500K (100K increments)
LIGHT INTENSITY | Dimmable 0 to 100 (smooth and flicker-free)
COLOR RENDERING INDEX | 95 CRI
TLCI | 95 TLCI
DIMENSIONS | 380 x 308 x 68 mm / 15 x 12 x 2,7" (panel)
WEIGHT | 4,2 kgs / 9 lbs (panel)
POWER DRAW | 100 W / 0,91 Amps at 110 VAC
POWER SUPPLY | 12-35V DC. Vlock or Gold battery mounts, 90-264V AC 50/60Hz

BEAM ANGLE | VELVET Power 1. 30° REF. VL1-IP54-Power-Flood
 Tunable with optional Optic Diffusers | VELVET Power 1 SPOT. 15° REF. VL1-IP54-Power-Spot

PHOTOMETRICS	VELVET POWER 1 FLOOD	VELVET POWER 1 SPOT
	14000 lux / 1296 fc at 1m / 3 feet	25000 lux / 2315 fc at 1m / 3 feet
	2000 lux / 185 fc at 3m / 10 feet	6000 lux / 555 fc at 3m / 10 feet
	550 lux / 51 fc at 6m / 20 feet	1500 lux / 139 fc at 6m / 20 feet

LED RATED LIFE | More than 50.000
POWER CONNECTION | XLR-3 DC IN connector + PSU or Vlock, Gold battery mounts
OUTPUT FREQUENCY | 16KHz (Flicker-free up to 3000 fps)
OPERATION TEMPERATURE | From -20°C to +40°C
COOLING | No-noise, fan-free passive cooling
PROTECTION | IP54 RAINPROOF, indoor or outdoor use
VELVET LED TECHNOLOGY | Selected BIN high-power LED + optic diffuser + CPU software control
RIGGING OPTIONS | Aluminum yoke with 16 baby receiver combined with 28 junior pin, four sliding threads 1/4" for riggings located on panel side, Pole operated Yoke, Quick Link Swivel ball head.
QUICK MOUNTING ACCESSORIES | AC power supply, Vlock or Gold battery adapters, DMX 512 splitter cable I&O, foldable Snaggrid, Optics Diffusers, Removable Barndoors, Cordura Soft bag, Hard Flight case.
CONSTRUCTION & FINISH | Black anodized extruded aluminum and black powder coated sheet aluminum

BATTERY POWER
12 to 35 VDC

Connect any battery from 12 to 35 VDC to the XLR3 connector located at the back of the panel

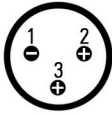

When powering VELVET from an external battery through the XLR3 connector check the proper polarity as shown in the picture at the side of the panel.

To ensure maximum performance of the equipment use only high-load capacity batteries with a high continuous draw meaning a Discharge Current of at least 7A.

BATTERY POWER
Vlock or Gold Battery

Insert the Vlock plate by sliding it into the slot located at the back of the panel.

Insert and extract the plate from the right hand of the panel where the digital display is located.

Connect the XLR3 to the connector located on the back of the panel.

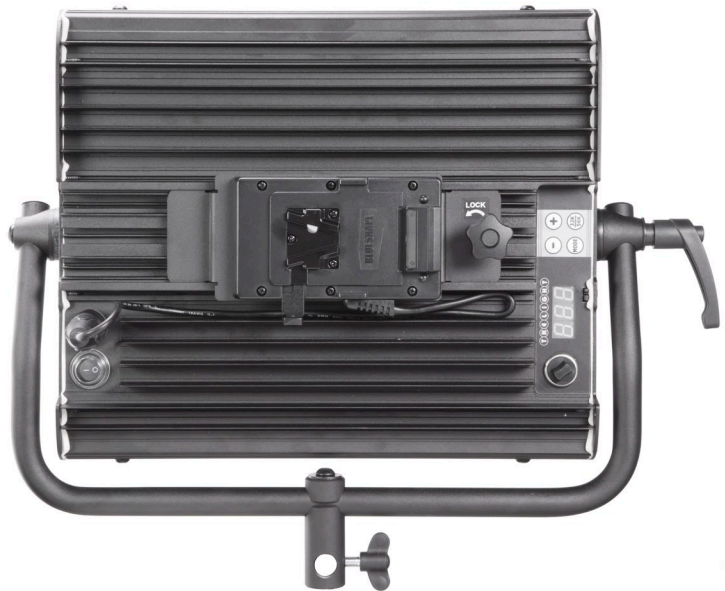
**DANGER**

Secure the Power supply plate by turning the locking knob anti clockwise

To avoid electric shocks and/or damages in the equipment the power switch located at the back of the LED panel must be off before connecting or disconnecting cables.

AC POWER 90 to 264 VAC

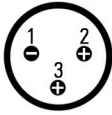

Insert the Power supply plate by sliding it into the slot located at the back of the panel.

Insert and extract the plate from the right hand of the panel where the digital display is located.

Connect the XLR3 to the connector located under the power switch. Connect the power cable to the plug located in the side of the power supply and the power plug with a mains power outlet.

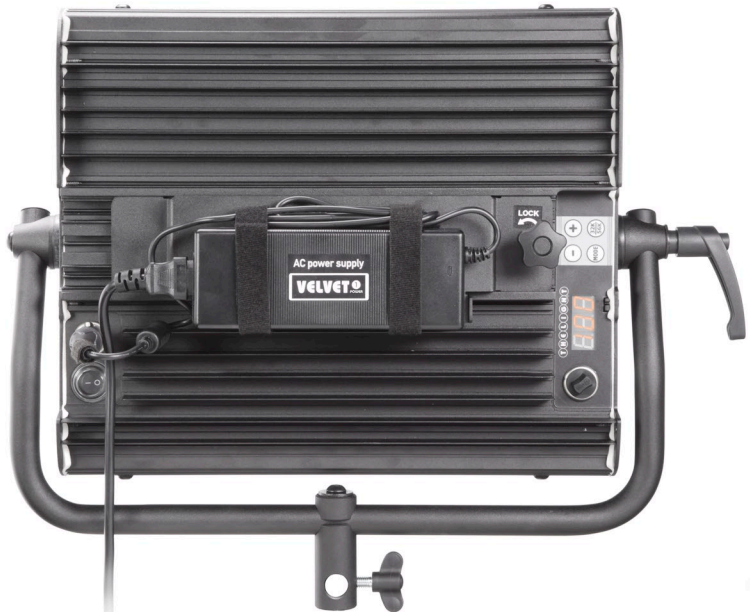

DANGER

Secure the Power supply plate by turning the locking knob anti clockwise

To avoid electric shocks and/or damages in the equipment the power switch located at the back of the LED panel must be off before connecting or disconnecting cables.



- 01 | Power switch
- 02 | XLR-3 DC IN
- 03 | XLR-5 DMX IN
- 04 | +/- Adjustment buttons
- 05 | 3200K/ 5600K Quick access button
- 06 | Mode selection button (Dimmer/ Colour Temp)
- 07 | Digital display
- 08 | XLR-5 DMX OUT

COLOUR TEMPERATURE Adjustable from 2700K a 6500K (100K increments)
LIGHT INTENSITY Dimmable 0 to 100 (smooth and flicker-free)
COLOR RENDERING INDEX 95 CRI
 TLCI 95 TLCI
DIMENSIONS 380 x 308 x 68 mm / 15 x 12 x 2,7" (panel)
WEIGHT 4,2 kgs / 9 lbs (panel)
POWER DRAW 100 W / 0,91 Amps at 110 VAC
POWER SUPPLY 90-264 VAC, 50/60 Hz

BEAM ANGLE VELVET Power 1. 30° REF. VL1-IP51-Power-Flood
 Tunable with optional Optic Diffusers VELVET Power 1 SPOT. 15° REF. VL1-IP51-Power-Spot

PHOTOMETRICS	VELVET POWER 1 FLOOD	VELVET POWER 1 SPOT
	14000 lux / 1296 fc at 1m / 3 feet	25000 lux / 2315 fc at 1m / 3 feet
	2000 lux / 185 fc at 3m / 10 feet	6000 lux / 555 fc at 3m / 10 feet
	550 lux / 51 fc at 6m / 20 feet	1500 lux / 139 fc at 6m / 20 feet

LED RATED LIFE	More than 50.000
POWER CONNECTION	XLR-3 DC IN connector
OUTPUT FREQUENCY	16KHz (Flicker-free up to 3000 fps)
OPERATION TEMPERATURE	From -20°C to +40°C
COOLING	No-noise, fan-free passive cooling
PROTECTION	IP51 DUSTPROOF, indoor or outdoor use
VELVET LED TECHNOLOGY	Selected BIN high-power LED + optic diffuser + CPU software control
RIGGING OPTIONS	Aluminum yoke with 16 baby receiver combined with 28 junior pin, four sliding threads 1/4" for riggings located on panel side, Pole operated Yoke, Quick Link Swivel ball head.
QUICK MOUNTING ACCESSORIES	AC power supply, Vlock or Gold battery adapters, foldable Snapgrid, Optics Diffusers, Removable Barndoors, Cordura Soft bag, Hard Flight case.
CONSTRUCTION & FINISH	Black anodized extruded aluminum and black powder coated sheet aluminum

AC POWER 90 to 264 VAC

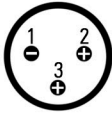

Insert the Power supply plate by sliding it into the slot located at the back of the panel.

Insert and extract the plate from the right hand of the panel where the digital display is located.

Connect the XLR3 to the connector located under the power switch.
Connect the power cable to the plug located in the side of the power supply and the power plug with a mains power outlet.



DANGER

Secure the Power supply plate by turning the locking knob anti clockwise

To avoid electric shocks and/or damages in the equipment the power switch located at the back of the LED panel must be off before connecting or disconnecting cables.

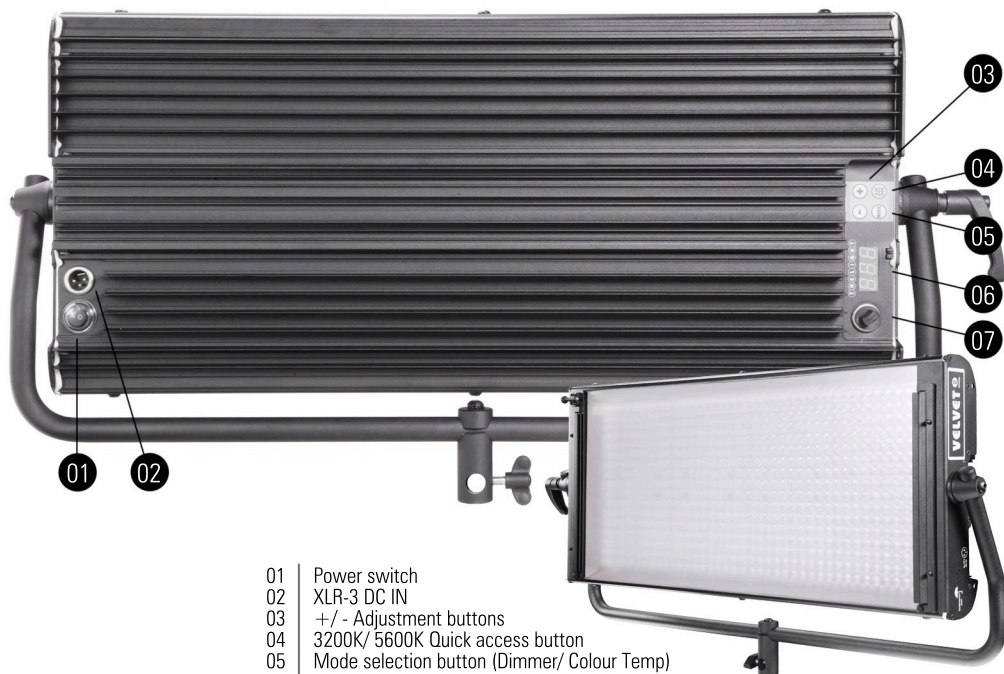

- 01 | Power switch
- 02 | XLR-3 DC IN
- 03 | +/- Adjustment buttons
- 04 | 3200K/ 5600K Quick access button
- 05 | Mode selection button (Dimmer/ Colour Temp)
- 06 | Digital display
- 07 | XLR-5 DMX IN&OUT

COLOUR TEMPERATURE Adjustable from 2700K a 6500K (100K increments)
LIGHT INTENSITY Dimmable 0 to 100 (smooth and flicker-free)
COLOR RENDERING INDEX 95 CRI
 TLCI 95 TLCI
DIMENSIONS 690 x 308 x 68 mm / 27 x 12 x 2.7" (panel)
WEIGHT 7 kgs / 15,5 lbs (panel)
POWER DRAW 190 W / 1,7 Amps at 110 VAC
POWER SUPPLY 24-35V DC. Via XLR-3 Double Vlock or Gold battery mount, 90-264V AC 50/60Hz

BEAM ANGLE VELVET Power 1. 30° REF. VL2-IP54-Power-Flood
 Tunable with optional Optic Diffusers VELVET Power 1 SPOT. 15° REF. VL2-IP54-Power-Spot

PHOTOMETRICS	VELVET POWER 2 FLOOD	VELVET POWER 2 SPOT
	25000 lux / 2315 fc at 1m / 3 feet	50000 lux / 4630 fc at 1m / 3 feet
	4000 lux / 370 fc at 3m / 10 feet	12000 lux / 1110 fc at 3m / 10 feet
	1000 lux / 93 fc at 6m / 20 feet	3000 lux / 278 fc at 6m / 20 feet

LED RATED LIFE More than 50,000
POWER CONNECTION XLR-3 DC IN connector + PSU or Vlock, Gold battery mounts
OUTPUT FREQUENCY 16KHz (Flicker-free up to 3000 fps)
OPERATION TEMPERATURE From -20°C to +40°C
COOLING No-noise, fan-free passive cooling
PROTECTION IP54 RAINPROOF, indoor or outdoor use
VELVET LED TECHNOLOGY Selected BIN high-power LED + optic diffuser + CPU software control
RIGGING OPTIONS Selected BIN high-power LED + optic diffuser + CPU software control
 Aluminum yoke with 16 baby receiver combined with 28 junior pin, four sliding threads 1/4" for riggings located on panel side, Pole operated Yoke, Quick Link Swivel ball head.
QUICK MOUNTING ACCESSORIES AC power supply, Vlock or Gold battery adapters, DMX 512 splitter cable I&O, foldable Snapgrid, Optics Diffusers, Removable Barndoors, Cordura Soft bag, Hard Flight case.
CONSTRUCTION & FINISH Black anodized extruded aluminum and black powder coated sheet aluminum

BATTERY POWER 24 to 35 VDC

Connect any battery from 24 to 35 VDC to the XLR3 connector located at the back of the panel

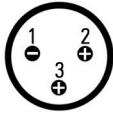

When powering VELVET from an external battery through the XLR3 connector check the proper polarity as shown in the picture at the side of the panel.

To ensure maximum performance of the equipment use only high-load capacity batteries with a high continuous draw meaning a Discharge Current of at least 7A.

BATTERY POWER Double Vlock or Gold Battery

VELVET Power 2 can also be powered with two Vlock or Gold batteries to double the running time.

Insert the VELVET 2 double Vlock plate by sliding it into the slot located at the back of the panel.

Insert and extract the plate from the right hand of the panel where the digital display is located



DANGER

VELVET 2 panel exclusively runs when two Vlock (or Gold Mount) batteries are inserted on the mounts.

Secure the Power supply plate by turning the locking knob anti clockwise

To avoid electric shocks and/or damages in the equipment the power switch located at the back of the LED panel must be off before connecting or disconnecting cables.

AC POWER 90 to 264 VAC

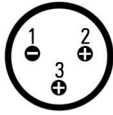

Insert the Power supply plate by sliding it into the slot located at the back of the panel.
Insert and extract the plate from the right hand of the panel where the digital display is located.

Connect the XLR3 to the connector located under the power switch.
Connect the power cable to the plug located in the side of the power supply and the power plug with a mains power outlet.



DANGER

Secure the Power supply plate by turning the locking knob anti clockwise

To avoid electric shocks and/or damages in the equipment the power switch located at the back of the LED panel must be off before connecting or disconnecting cables.

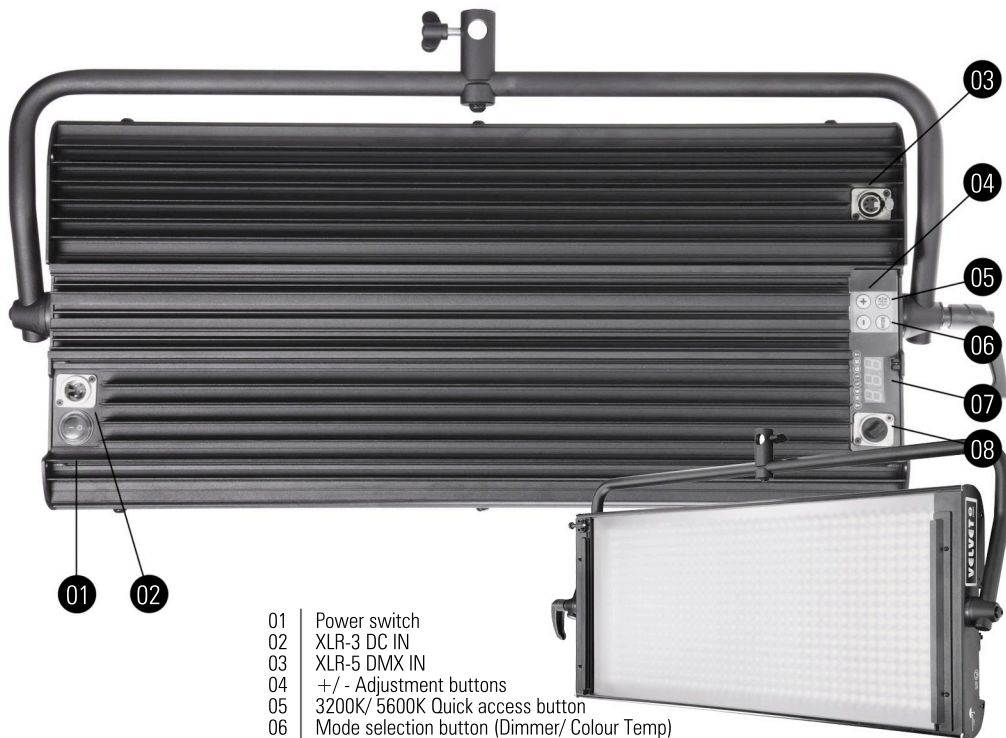

- 01 | Power switch
- 02 | XLR-3 DC IN
- 03 | XLR-5 DMX IN
- 04 | +/- Adjustment buttons
- 05 | 3200K/ 5600K Quick access button
- 06 | Mode selection button (Dimmer/ Colour Temp)
- 07 | Digital display
- 08 | XLR-5 DMX OUT

COLOUR TEMPERATURE | Adjustable from 2700K a 6500K (100K increments)
LIGHT INTENSITY | Dimmable 0 to 100 (smooth and flicker-free)
COLOR RENDERING INDEX | 95 CRI
TLCI | 95 TLCI
DIMENSIONS | 690 x 308 x 68 mm / 27 x 12 x 2,7" (panel)
WEIGHT | 7 kgs / 15,5 lbs (panel)
POWER DRAW | 190 W / 1,7 Amps at 110 VAC
POWER SUPPLY | 90-264 VAC, 50/60Hz

BEAM ANGLE | VELVET Power 1. 30° REF. VL2-IP51-Power-Flood
 Tunable with optional Optic Diffusers | VELVET Power 1 SPOT. 15° REF. VL2-IP51-Power-Spot

PHOTOMETRICS	VELVET POWER 2 FLOOD 25000 lux / 2315 fc at 1m / 3 feet 4000 lux / 370 fc at 3m / 10 feet 1000 lux / 93 fc at 6m / 20 feet	VELVET POWER 2 SPOT 50000 lux / 4630 fc at 1m / 3 feet 12000 lux / 1110 fc at 3m / 10 feet 3000 lux / 278 fc at 6m / 20 feet
---------------------	--	--

LED RATED LIFE | More than 50.000
POWER CONNECTION | XLR-3 DC IN connector
OUTPUT FREQUENCY | 16KHz (Flicker-free up to 3000 fps)
OPERATION TEMPERATURE | From -20°C to +40°C
COOLING | No-noise, fan-free passive cooling
PROTECTION | IP51 DUSTPROOF, indoor or outdoor use
VELVET LED TECHNOLOGY | OSRAM selected BIN LED core unit + optic diffuser + CPU software control
RIGGING OPTIONS | Aluminum yoke with 16 baby receiver combined with 28 junior pin, four sliding threads 1/4" for riggings located on panel side, Pole operated Yoke, Quick Link Swivel ball head.
QUICK MOUNTING ACCESSORIES | AC power supply, Vlock or Gold battery adapters, foldable Snapgrid, Optics Diffusers, Removable Barndoors, Cordura Soft bag, Hard Flight case.
CONSTRUCTION & FINISH | Black anodized extruded aluminum and black powder coated sheet aluminum

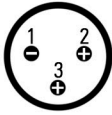
AC POWER
90 to 264 VAC

Insert the Power supply plate by sliding it into the slot located at the back of the panel.

Insert and extract the plate from the right hand of the panel where the digital display is located.

Connect the XLR3 to the connector located under the power switch.
Connect the power cable to the plug located in the side of the power supply and the power plug with a mains power outlet.

**DANGER**

Secure the Power supply plate by turning the locking knob anti clockwise

To avoid electric shocks and/or damages in the equipment the power switch located at the back of the LED panel must be off before connecting or disconnecting cables.

YOKE TO PANEL assembling

Align the adjustable Yoke with the VELVET Power 1/2 panel as shown in the picture.



Assemble the Yoke to the LED panel by using the mounting kit of bolts, washers and adjustable handle. First mount the handles with the metric M8 metal washer then insert the thick rubber washers between the Yoke and the LED panel.

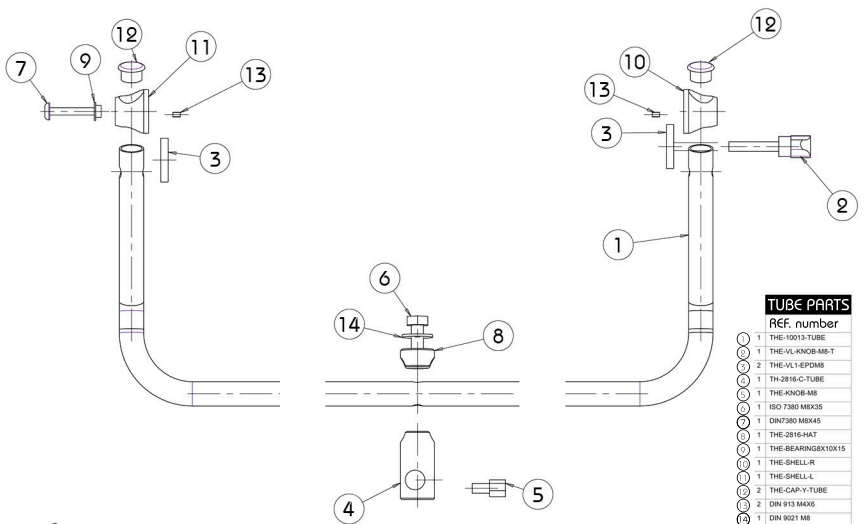

WARNING

It is mandatory to mount the rubber washers (tube parts 3) between the Yoke and the panel to warranty the rainproof IP54 in LOCATION models.

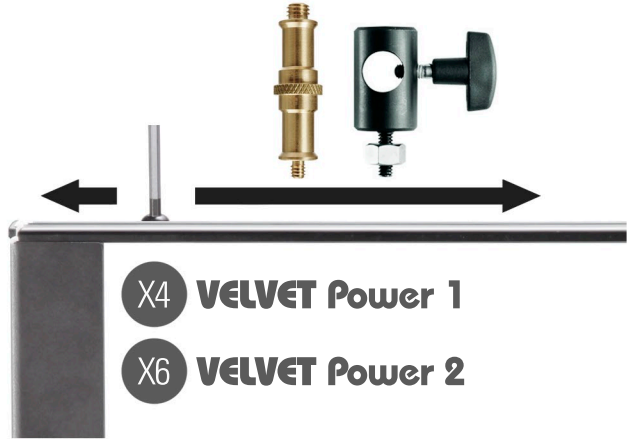
**MOUNTING OPTIONS**

VELVET Power panels have been designed to be easily installed and hidden on tight locations or low ceiling rooms.

They can be rigged up in many ways through the adjustable yoke, swivel ball head or by using the sliding 1/4-20" threads and bolts located on both top and bottom of any VELVET panel.

**SECURITY CABLES**

The LED panel is provided with several holes specially design to insert one or more snaps and their safety cable.

**WARNING**

When a VELVET panel and any other component is mounted in a hanging position it must be secured with a safety cable rated at a minimum of ten times the weight of the light fixture including its accessories.

POWER ON/OFF

Turn on the equipment by switching on the power button. The light settings always remain stored when the digital control is powered off. By pushing the MODE button you can select either Color temperature or Dimmer adjustment.

The digital control enables to adjust the following light parameters through its programmed CPU:

- Calibrated Color Temperature variation
- Stable colour dimming

COLOR TEMPERATURE variation

VELVET Power includes a dedicated button to immediately set 3200K or 5600K.

Color temperature can also be increased or reduced through the +/- buttons located at the digital control panel. The display indicates either the selected color temperature or the dimming value.

When Color temperature is selected a dot "." appears between the two digits value. The value 3.2 corresponds to 3200K and the value 3.3 to 3300K and so on.



Push the "+" button to increase color temperature or push the "-" button to decrease it. If you keep pushed any of the buttons you will get a fast continuous variation. Every push on the buttons will increase or decrease the color temperature in increments of 100 Kelvin.

DIMMER intensity variation

The dimmer is totally digital and guarantees the regulation of light intensity with minimal changes in the selected color temperature.

Light intensity can be easily increased or reduced through the +/- buttons located at the digital control panel. The display indicates the selected dimmer value from 1 to 100.

Push the + button to increase light intensity or push the - button to decrease it. If you keep pushed any of the buttons the you will get a fast continuous variation.

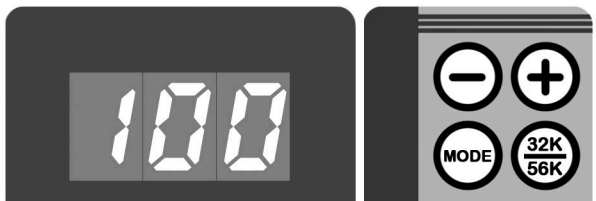

**MASTER-SLAVE
function**

The integrated Master-slave function allows to link an array of any VELVET Power products together and operate them all without a controller. The first VELVET fixture will be the Master acting as the controller and all the others will react and copy the color temperature and dimmer values. Use DMX XLR-5 in&out splitter cables (ref. THE-VL-DMXinout) to daisy chain several VELVET panels. Any VELVET Light, Power or MINI can be mixed in the same chain because they are fully compatible.

To make the first unit as the Master follow this steps:

- 01 Switch off the power button
- 02 Push “+” and “-” buttons at the same time and then switch on the power button
- 03 Now the unit is in DMX mode and any DMX channel can be addressed
- 04 Push the “-” button until “n n t” will be shown in the display

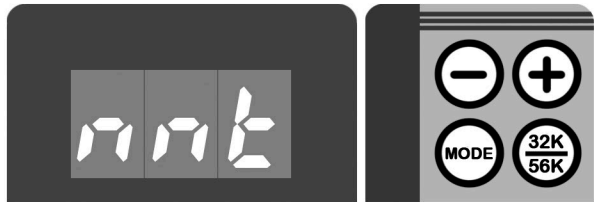

- 05 Push “32K/56K” button to confirm the MASTER mode
- 06 A dot will permanently blink on the display reminding that the panel is set as MASTER

NOTE Every time you switch off the power button the VELVET panels are automatically set to SLAVE mode



WARNING

Only the first VELVET panel on the chain can be the Master. Every other VELVET panels must be set on standard Slave mode and address at channel 001.



WARNING

The VELVET panel set as MASTER cannot control any other lighting fixture out of VELVET Light, Power or MINI not even other VELVETLight articulated products.

DMX RDM control

VELVET fixtures have been designed for a full bi-directional DMX RDM control from the 5-pin DMX port located at the back of the fixture. Once the DMX controller is powered ON a dot "." appears in the right down corner of the digital display as DMX operation status reminder.

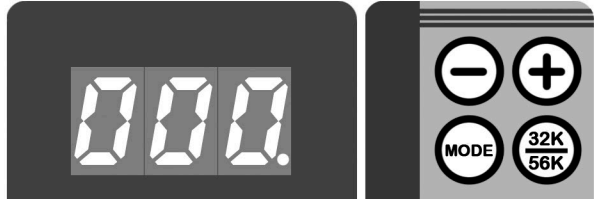

Use DMX XLR-5 in&out splitter cables (ref. THE-VL-DMXinout) to daisy chain several VELVET non STUDIO panels or mix them within any DMX line of different fixtures.

ADDRESSING CHANNELS

To address the DMX channel on any VELVET panel follow this steps:

Switch off the power button

01 Push "+" and "--" buttons at the same time and then switch on the power
02 button.

Now the unit is in DMX mode and any DMX channel can be addressed

03 Push the "+" or "--" buttons to increase or decrease the first fixture
04 address.

05 Once you have chosen the desired address number push the "32K/56K" button to save the selection.

Keep in mind the following points regarding DMX control:

- VELVET DMX protocol uses 2 channels per fixture
- After the DMX address is entered the fixture will automatically assign the following channel
- If you wish to control several VELVET fixtures at the same values you will have to set them to the same address
- If you wish to control several VELVET fixtures independently you will have to offset their address by 2 channels. Example
fixture1 address 001 -- fixture2 address 003 -- fixture3 address 005

DMX CHANNELS

When you connect your console to VELVET you will be able to control the fixtures through 2 channels:

CH01 START ADDRESS

COLOUR TEMPERATURE From 2.7 to 6.5 (from 2700Kelvin to 6500Kelvin)

CH02 START ADDRESS+1

Fader=0 (2.7) means 2700Kelvin / Fader=100 (6.5) means 6500Kelvin
DIMMER

NOTES

Do not use microphone cables or other general purpose two-core cables designed for audio or signal use. They are not suitable for DMX 512. Problems due to wrong cabling may not be immediately perceptible. Microphone cables may appear to work fine, but systems built with such cables may fail or be susceptible to random errors. Cable must comply with RS-485 DMX protocol (EIA485).

A DMX terminator should be plugged into the final, empty, OUT connector of the last slave on the daisy chain. A terminator is a stand-alone male connector with a built-in 120 Ω resistor, matching the cable characteristic impedance, connected across the primary data signal pair.

SNAPGRID, SNAPBAG installation

Position the VELVET panel with the light pointing up. Unfold the Snapgrid, place it over the VELVET diffuser and flip the elastics over the panel corners to secure it.

The side covers prevent emitting of spill light.
The Snapgrid produce a 40° beam angle.



Included HEXAGONAL SPUD use

You can place the Vlock, Gold mount or AC Power on any stand mast for a handy use close to the lamp head.

To do so you will need to use a regular Super Clamp (not included in the kit) and insert the Hexagonal 5/8" (16mm) baby spud.

Once installed the hexagonal spud, just slide the holder (located at the Vlock, Gold mount or AC Power) bottom over the spud plate until properly seated, as shown in the picture.

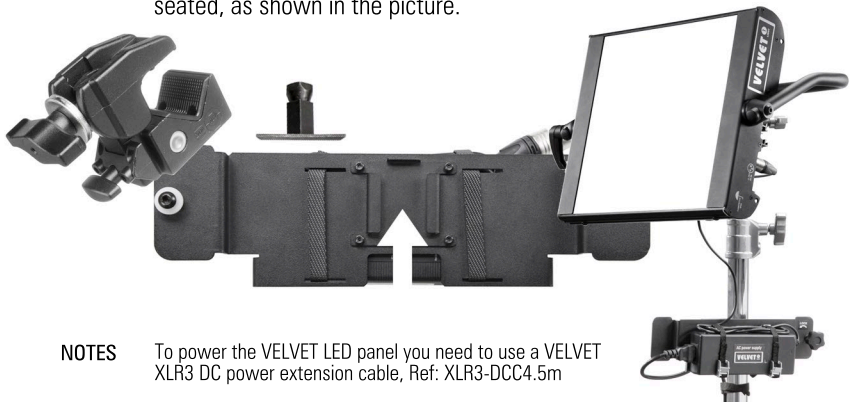

NOTES

To power the VELVET LED panel you need to use a VELVET XLR3 DC power extension cable, Ref: XLR3-DCC4.5m

SNAPGRID & SNAPBAG CLOTH FLAMEPROOF RATING

The Snapgrid has been manufactured with black cloth which meets the flameproof standards UNE EN 1101 and EN 13772

(x, y CIE-1931)

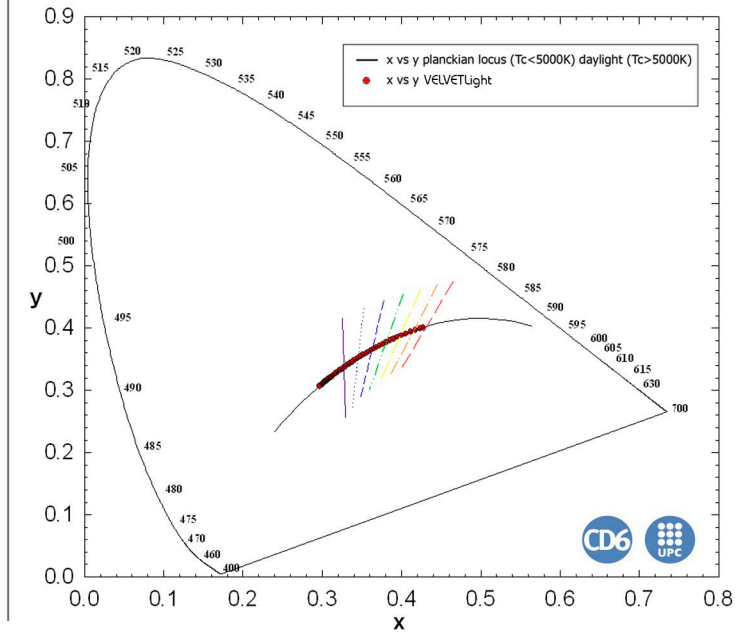

Shown on the diagram are the VELVET lamp head chromaticity coordinates (x, y CIE-1931) feed and digitally controlled by its Control Unit and they are compared with the reference illuminants. These reference illuminants are the Planckian locus radiator set below 5000K and the CIE daylight reference is set over 5000K. The Planckian locus radiator references the chromaticity for several tungsten lamps colour temperatures while the daylight locus typify daylight type D illuminants.

The diagram evidence the light emanated by VELVET luminary at every colour temperature entirely matches with the described locus reference so that the colour of the light produced is essentially the same as incandescent and daylight. It is also remarkable the minimum green/magenta deviation over the locus reference along the range of colour temperatures (means minimal difference between VELVET chromaticity coordinates and the ideal reference line).

CALIBRATION

The Instrument Systems scanning spectrometer, model Spectro 320, serial number 30932004, with its accessory TOP-100 has been calibrated according to the United States National Institute of Standards (NIST) and the german Physikalisch-Technische Bundesanstalt (PTB) standard references.

ACCURACY

The Instrument Systems scanning spectrometer, model Spectro 320, serial number 30932004, with its accessory TOP-100 has an imprecision over the spectral radiometric results delivered lower than 1%.

Specifications subject to change without notice. VELVET technology is protected under Spanish license laws with international patents pending.
THELIGHT luminary for cine and tv, S.L. www.velvetlight.tv

This equipment is designed to meet the following regulations and safety standards for battery powered technology equipment:

ENVIROMENTAL	Devices are certified and intended for indoor or outdoor use (IP54 or IP51) LAMP HEAD OPERATION TEMPERATURE from -20° to +40° C OPERATING HUMIDITY from 30 to 90% RH non condensing DECLARATION OF CONFORMITY TO EMC DIRECTIVE 2004/108 EC
MANUFACTURER name & address	VELVET (Thelight luminary for cine and tv, S.L.) Carrer de la Cerdanya 11-A. 08192 Sant Quirze del Vallés. BARCELONA, SPAIN. info@velvetlight.tv / www.velvetlight.tv
STANDARDS	<p>EC - DECLARATION OF CONFORMITY Brand Name: VELVET</p> <p>Product Description: LED Luminaire systems for professional use VELVET Power 1, VELVET Power 2, VELVET Power 2x2, VELVET Light 1, VELVET Light 2, VELVET Light 2x2, VELVET Light 4, MINI 1, MINI 2, MINI 3, MINI 1 Power, MINI 2 Power, VELVET Sword 2, VELVET Sword 4.</p> <p>The above products abide by the following European Directives:</p> <p>DIRECTIVE 2014/30/EU of the European Parliament and of the Council of 26 February 2014 on the harmonization of the laws of the Member States relating to electromagnetic compatibility. DIRECTIVE 2014/35/EU of the European Parliament and of the Council of 26 February 2014 on the harmonization of the laws of the Member States relating to the making available on the market of electrical equipment designed for use within certain voltage limits. DIRECTIVE 2001/95/EC of the European Parliament and the Council of 3 December 2001 on general product safety DIRECTIVE 2011/65/EU of the European Parliament and of the Council of 8 June 2011 on the restriction of the use of certain hazardous substances in electrical and electronic equipment. In compliance with the harmonized standards: IEC 60598-1:2014 Luminaires – Part 1: General requirements and tests IEC 60598-1-17:2017 Luminaires – Part 2-17: Particular requirements – Luminaires for stage lighting, television and film studios (outdoor and indoor) IEC 62031:2008/A1:2012 LED modules for general lighting - Safety specifications IEC 61547:2009 Equipment for general lighting purposes - EMC immunity requirements IEC 61000-6-1:2005 Electromagnetic compatibility (EMC) -- Part 6-1: Generic standards - Immunity for residential, commercial and light-industrial environments IEC 61000-6-3:2006/A1:2010 Electromagnetic compatibility (EMC) - Part 6-3: Generic standards - Emission standard for residential, commercial and light-industrial environments IEC 61000-6-4:2006/A1:2010 Electromagnetic compatibility (EMC) -- Part 6-4: Generic standards - Emission standard for industrial environments EN 301489-1 V1.8.1 Electromagnetic compatibility and Radio spectrum Matters (ERM); Electromagnetic Compatibility (EMC) standard for radio equipment and services; Part 1: Common technical requirements IEC 62493:2009 Assessment of lighting equipment related to human exposure to electromagnetic fields EN 55015:2013 Limits and methods of measurement of radio disturbance characteristics of electrical lighting and similar equipment EN 62471:2008 Photobiological Safety of Lamps and Lamp Systems</p>

Sant Quirze del Vallés. BARCELONA, 12 March 2018
Administrator - Javier Fdez. de Valderrama



VELVET Power 1 Weight: 4,2 kgs / 9 lbs. Power draw 100 W / 0,91 Amps at 14,4 VDC.
 FLOOD/SPOT IP54 protection

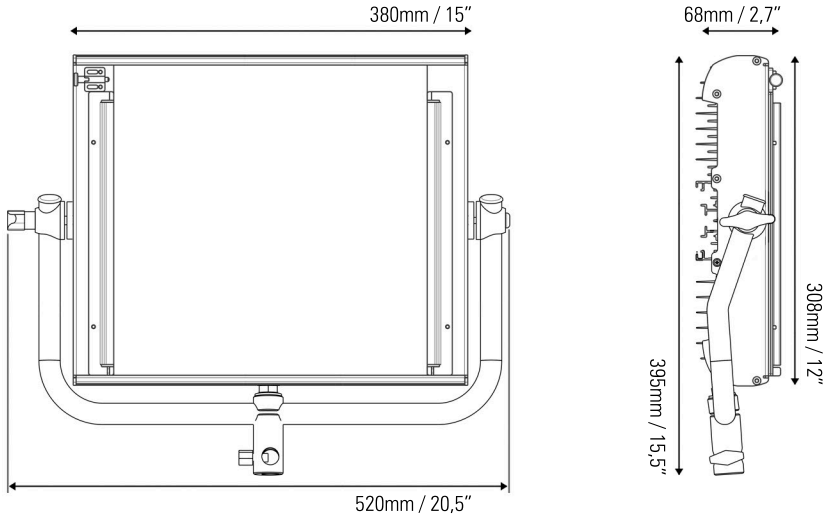

VELVET Power 2 Weight: 7 kgs / 15,5 lbs. Power draw 190 W / 1,7 Amps at 14,4 VDC.
 FLOOD/SPOT IP54 protection

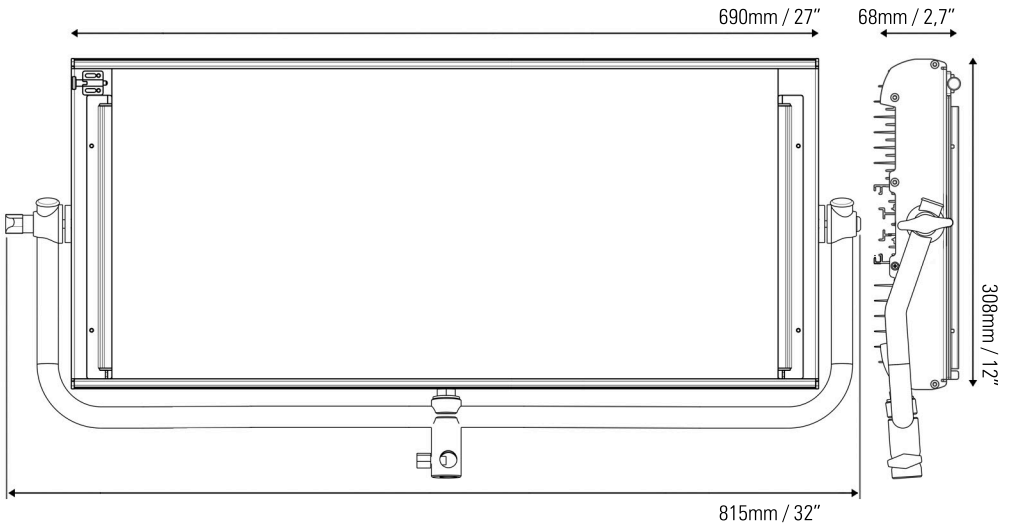

VELVET Power 1 Weight: 4,2 kgs / 9 lbs. Power draw 100 W / 0,91 Amps at 14,4 VDC.
 FLOOD/SPOT IP51 protection

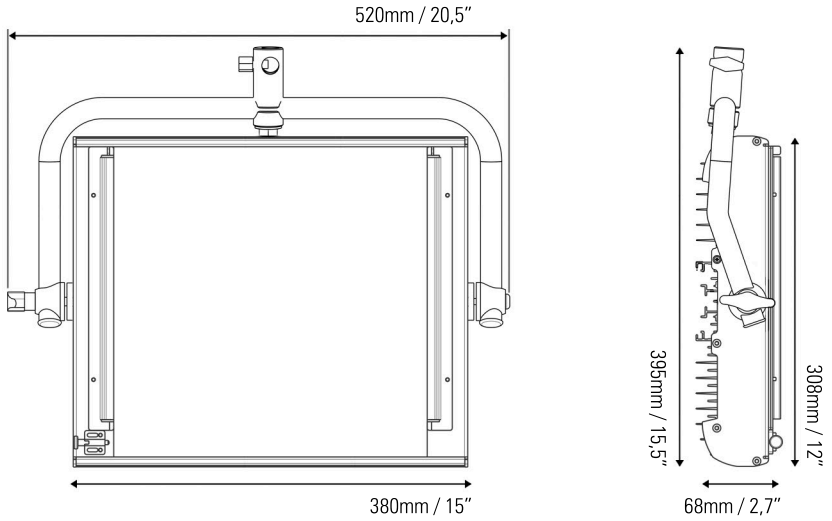

VELVET Power 2 Weight: 7 kgs / 15,5 lbs. Power draw 190 W / 1,7 Amps at 14,4 VDC.
 FLOOD/SPOT IP51 protection

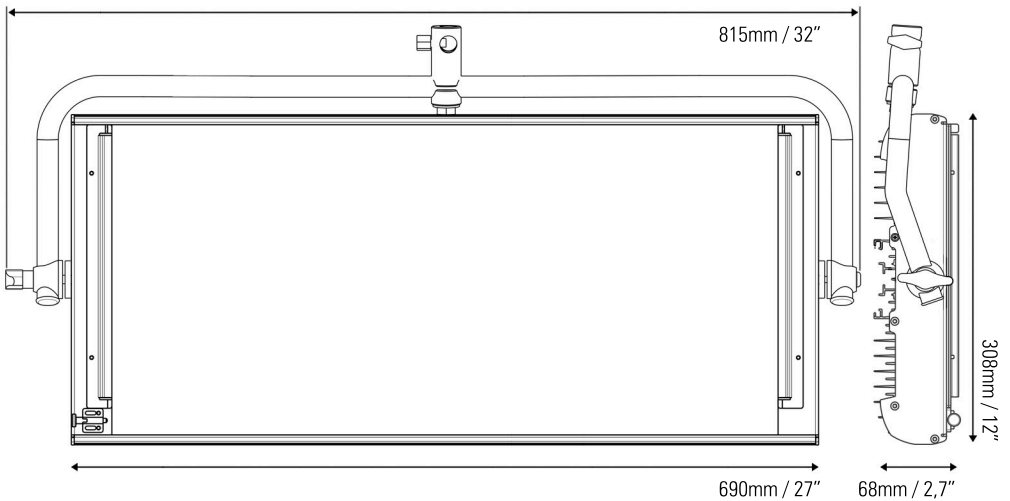

GENERAL WARRANTY

VELVET LED equipments are guaranteed to be free from defects in workmanship and parts in a warranty period of two (2) years from the date of purchase. Defects that occur within this warranty period, under normal use and care will be repaired or replaced at VELVET discretion, solely at our option with no charge for parts or labour.

In the event of the equipment malfunction, contact the dealer from which you purchased the product. Please note that you will be not be reimbursed for the cost of bringing the equipment to the VELVET Repair Centre.

VELVET reserves the right to replace the product or relevant part with the same or equivalent product or part, rather than repair it. Where a replacement is provided the products or part replaced becomes the property of VELVET. VELVET may replace parts with refurbished parts. Replacement of the product or a part does not extend or restart the Warranty period.

RETURN POLICY

Returns or exchanges from the customers will be accepted within 15 days of delivery and will not include the actual shipping costs. Item(s) must be in original packaging and condition, must not be assembled, and must include its original user manual.

This warranty does not cover any damage resulting from:

- Failure to follow the instructions in the instruction manual Repair, modification or overhaul not conducted by any authorized VELVET personnel.
- Fire, natural disaster, act of God, lightning, abnormal voltage, etc;
- Submergence in water (flooding), exposure to alcohol or other beverages, infiltration of sand or mud, physical shock, or dropping of the equipment and other unnatural causes.

This warranty only applies to the LED panel and not to the accessories, such as barn doors or mounts.

Any consequential damages arising from failure of the equipment, such as expenses incurred in taking pictures or recording images or loss of expected profit, will not be reimbursed whether they occur during the warranty period or not.

Parts essential to the servicing of the light equipment (that is, components required to maintain the functions and quality of the fixture) will be available for a period of five years after the product is discontinued.

THELIGHT Luminary for cine and tv, S.L.
www.velvetlight.tv

The total or partial reproduction of this guide is prohibited without the express written permission of VELVET.

VELVET technology is protected under Spanish license laws with international patents pending.

Information and specifications in this document are subject to change without notice.

velvetlight.tv



made to last

2021. Copyright VELVET. All rights reserved