

SEKONIC Spectrometer

SPECTROMASTER C-7000

Operating Manual

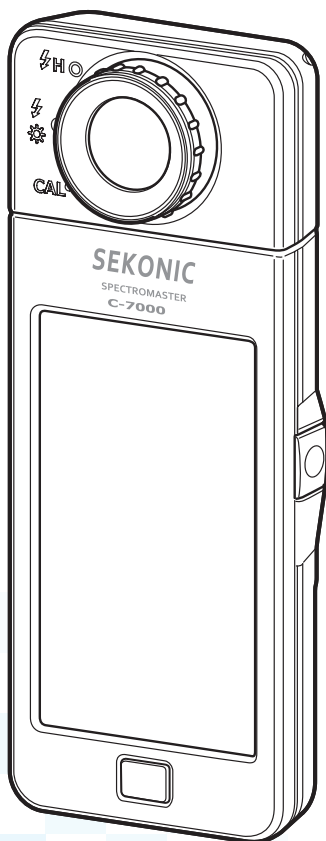

Please read the operating manual carefully to fully understand the features of this product before use and keep it for future use. Keep the operating manual in a safe place. Please see the Startup Guide for information about the basic operations.

Congratulations on your purchase of a Sekonic SPECTROMASTER C-7000. Please read the operating manual carefully to properly utilize the many features and benefits of this precision instrument.

The Sekonic SPECTROMASTER C-7000 is a portable spectrometer equipped with CMOS linear image sensor that can measure from 380nm to 780nm. Its large color LCD, conveniently displays correlated color temperature, color rendering index (CRI), chromaticity diagrams and color spectrum of various light sources. The Sekonic C-7000 illuminance measurement complies with JIS Class A and DIN 5032 Part 7 Class C standard making it a reliable illuminometer. Its capabilities make it suitable for checking the quality of a light source during manufacturing and inspection processes, as well as measuring the quality of light for various areas such as office environments, construction sites, road lighting, and factory spaces.

The application software of "C-7000 Utility" can be used to save the measurement and graphic display, change the meter setting and update the firmware while meter is connected to computer or tablet by USB cable.





* Download the Utility from www.sekonic.com, and install it on your computer. URL: www.sekonic.com/support/downloads/dtssoftwareformacandwindows.aspx. To use this Utility, connect your computer to the C-7000 using a USB cable (Mini-B type, available commercially).

■ Terminology and trademarks

- Windows is a registered trademark of Microsoft Corporation in the USA and/or other jurisdictions.
- The official name of Windows is "Microsoft® Windows® Operating System."
- Macintosh and Mac OS are registered trademarks of Apple Computer, Inc. in the United States and/or other countries.
- X-Rite and ColorChecker are trademarks or registered trademarks of X-Rite, Incorporated in the United States and/or other countries. All rights reserved.
- All other company or product names are trademarks or registered trademarks of the respective companies.

■ Safety Precautions

Before using this product, please read this "Safety Precautions" for proper operation.

 WARNING	The WARNING symbol indicates the possibility of death or serious injury if the product is not used properly.
 CAUTION	The CAUTION symbol indicates the possibility of minor to moderate personal injury or product damage if the product is not used properly.
 NOTICE	The NOTICE symbol indicates cautions or restrictions when using the product. Please read all notes to avoid errors in operation.
 NOTE	The reference symbol indicates additional information about the controls or related functions. Reading these is recommended.
	The arrow indicates reference pages.

WARNING

- **Infants or toddlers may accidentally wrap the strap around their neck, so please place it in a location out of their reach. There is a danger of suffocation.**
- **Do not place batteries in open flames, attempt to short, disassemble or apply heat to them, or use unspecified batteries. They may burst and cause fires, serious injury, or damage to the environment.**
- **Do not use the spectrometer in a place containing flammable or combustible vapors. Otherwise, it may cause a fire.**
- **Do not to drop fluids on the spectrometer. Also, do not attempt to insert metals into it. Doing so may cause a fire or an electric shock. If any fluid drops on or a metal is inserted into the spectrometer, turn the power OFF immediately, and remove the battery (or unplug the USB power cable). Then, consult our Support Center for assistance.**
- **Do not disassemble or modify this spectrometer. Doing so may cause a fire or an electric shock.**

CAUTION

- Do not handle this product with wet hands, or leave it in the rain or in a location where it may be splashed with water, submerged, or come into contact with moisture. There is a danger of electric shock if the "Flash Light Cord (PC) Mode" is used. This may also result in damage to the product.
- Do not attempt to disassemble the product for modification or parts replacement. It may affect measurement results or damage the meter.
- Any significant impact to the meter housing or LCD screen can cause physical damage and failure of performance. Even when the meter is in the bag or pocket, damage is possible under severe impact or pressure conditions.
- Do not attempt to play the included CD-ROM using an audio CD player. It may impair hearing or damage speakers and earphones.
- Gently tap the meter's LED panel when changing modes or making selections. Using pointed pens or pencils may scratch the LCD screen or damage the product.
- Infants or toddlers may accidentally grab the strap and swing the product, so please place it in a location out of their reach, as the meter may be damaged by impacts.
- Be careful that the neck strap does not come loose when carrying the product, as the meter may be damaged when dropped.
- This neck strap is made of polyester fiber. Please refrain from using the product if synthetic fibers cause your skin to become irritated, inflamed or itchy in order to prevent worsening your symptoms.
- Do not measure a bright object that emits light exceeding the measuring range (wavelength and illuminance). They may damage the optical components and result in inaccurate measurement.
- Before removing or replacing the battery or USB cable, always turn the power switch OFF. Otherwise, the spectrometer may fail.
- Do not place the product on an unstable or tilted bench. Otherwise, it may drop and you may be injured.

■ CA Prop 65

WARNING

This product can expose you to chemicals including lead, which is known to the State of California to cause cancer, and Di (2-ethylhexyl) phthalate (DEHP), which is known to the State of California to cause birth defects or other reproductive harm.

For more information, go to www.P65Warnings.ca.gov.

 **NOTICE**

- A protective sheet is attached to the LCD. Peel it off before use.
- Although the LCD monitor is manufactured to very high standards, it is possible to observe a few dead pixels on the screen. This is normal and not a malfunction of the meter.
- Do not use the meter in Cord Flash Mode at altitudes above 2,000m (6,561 feet).
- Our company shall not be liable for any data loss caused by, but not limited to, malicious acts and control errors.
- You can install the software on the included CD-ROM only when you agree with all articles in the license agreement that comes with the CD-ROM.
- Be sure not to drop the meter or subject it to sudden impacts, as the meter will be damaged.
- Do not store the meter in areas of high temperature or high humidity, as the meter will be damaged.
- Be careful not to transport the meter from cold to warm moist conditions as condensation will form on the meter and may damage it.
- If the meter is operated in temperatures below -10°C , the response of the LCD will greatly slow down and the display may be difficult to view and read. This will not harm the meter. Also, if the temperature exceeds 50°C , the liquid crystal display will darken and become difficult to read, but when it returns to room temperature it will return to its normal condition.
- If the meter is left in direct sunlight, a vehicle, or near a heater, the unit's temperature will rise and may result in damage. Please be careful when using the meter in these types of locations.
- If the meter is left where corrosive gases may be generated, the gases may affect the product and may result in damage. Please be careful when using the meter in these types of locations.
- In case of disposing the meter, follow the rules of disposal in your area.

Maintenance Notes

- Be careful not to let the Light Receptor become dusty, dirty, or scratched as this may affect the precision of the measurement.
 - If the meter becomes dirty, wipe it with a dry, soft cloth. Never use organic solvents such as thinner or benzene.
-

 **NOTE**

- For used batteries, dispose of them according to the rules of your area.
 - Insulate plus and minus terminals with tape or other insulation material.
 - Do not disassemble the batteries.
-

■ Intended Usage

The meter is designed for:

- Measuring correlated color temperature, deviation, color rendering properties (CRI, TM-30, SSI, TLCI/TLMF), illuminance, tristimulus value, chromaticity coordinates, dominant wavelength and excitation purity of various lighting sources such as LEDs, organic EL's and projectors.
- Measuring automotive LED headlights and other types of lamps.
- Measuring the illuminance of optical bio-reactions.
- Controlling the illuminance and monitoring spectral distribution of light source for indoor agriculture.
- Evaluating the illuminance, color temperature, and color rendering properties of road lighting, indoor lighting, store lighting, and others.
- Checking the quality, illuminance and color of light source in production of any kinds of light source manufacturers.

Main features of the C-7000

Model name	Usage	Features
C-7000	Industrial applications	<p>Monitoring and controlling illumination and color of light sources for industrial and environmental applications.</p> <ul style="list-style-type: none"> • Display the various color rendering properties such as CRI, SSI, TLCI, TLMF, and TM-30. • Display the enhanced measurement units. <ol style="list-style-type: none"> (1) Color temperature (K= Kelvin) (2) Color deviation (uv) (3) CIE1931 and CIE1964 (xy chromaticity diagrams) (4) CIE1976 (u'v' chromaticity diagram) (5) CRI (Ra, R1 to R15) (6) Illuminance/luminous exposure (ambient light/ flash light) (7) TM-30-18 (Rf, Rg) (8) SSI (comparison with known standards or memorized value) • Various Display modes <ol style="list-style-type: none"> (1) Color temperature (K= Kelvin) (2) Text mode (3) Spectrum graph/comparison mode (4) CRI/comparison mode (5) TM-30 mode (6) SSI mode (7) TLCI/TLMF mode (8) Displaying in CIE1931 (CIE1964) Comparison mode

■ Intended Users

The intended users of this product are the following.

- People monitoring the quality control of LED, OLED, projector illumination, etc.
- People controlling of illumination during installation and use of lamps used in museums, restaurants, work spaces, etc.
- People controlling color and brightness of illumination used for indoor agriculture.



■ Restrictions

There are some cautions and restrictions regarding the use of this product. Please read and understand the following before using the meter.



- The contents of this manual may be subject to change for the product's specification modifications and other reasons without prior notice.
We recommend that you download the latest operating manual from our website and use this product.
URL: www.sekonic.com/support/instructionmanualuserguidedownload.aspx
 - The safety-related precautions such as «Safety Guide and Maintenance» and «Safety Precautions» conform to the legal and industry standards that were applicable at the time this operating manual was created. Therefore, this manual may not contain the latest information. If you are using the previous operating manual, please download and refer to the latest operating manual.
 - The product may contain printing materials such as cautions related to safety and/or printing errors as a supplement to the operating manual.
 - The contents of this operating manual may be reproduced for non-commercial purposes and for personal use only. However, the reproduced material must contain the copyright notice of our company.
 - The reproduction of all or any part of this document without permission is strictly forbidden.
 - The product concerned and/or this manual may be subject to future changes without prior notification.
 - The screens in this operating manual may differ from the actual displays of the meter you are using. (Colors, letters, etc.)
-

Table of Contents

■ Terminology and trademarks	
■ Safety Precautions	i
 WARNING	i
 CAUTION	ii
■ CA Prop 65	ii
■ Intended Usage	iv
■ Intended Users	v
■ Restrictions	v
■ Accompanying Accessories	vi
1. Parts Designations and Functions	1
■ 1-1 Parts Designations	1
■ 1-2 Parts Functions	2
2. Before Use	3
■ 2-1 Attaching the Strap	3
■ 2-2 Installing the Batteries	4
■ 2-3 Power ON/OFF	5
■ 2-4 Automatic Power OFF Function	9
■ 2-5 Checking the Battery Capacity	10
■ 2-6 Automatic Power OFF Function	11
3. Screen Operation	12
■ 3-1 Screen and Operation	12
■ 3-1-1 Basic Screen and Operation	12
■ 3-1-2 Icon Operation	17
■ 3-1-3 Input of Numbers/Characters	18
■ 3-1-4 Locking and Unlocking the Screen	20
4. Basic Operations	21
■ 4-1 Basic Measurement Flow	21
■ 4-2 Selecting the Measuring Mode	23
■ 4-2-1 Matching Measuring Mode with Light Sources	23
■ 4-2-2 Selecting the Exposure Time (Ambient Modes Only)	25
■ 4-2-3 Selecting the Shutter Speed (Flash Modes Only)	26

4-3	Customizing Measuring Displays	28
4-4	Selecting the Display Mode	30
4-4-1	Displaying in Text [Text] Mode	35
4-4-2	Displaying in Spectrum Graph [Spectrum] Mode	38
4-4-3	Displaying in Color Rendering Index [CRI] Mode	41
4-4-4	Displaying in TM-30 [TM-30] Mode	44
4-4-5	Displaying in Spectral Similarity Index [SSI] Mode	46
4-4-6	Displaying in TLCI or TLMF [TLCI/TLMF] Mode	57
4-4-7	Displaying in CIE1931 (CIE1964) [CIE1931 (CIE1964)] Mode	62
4-4-8	Displaying in CIE1976 [CIE1976] Mode	64
4-4-9	Displaying in Spectrum Comparison [Spectrum Comp.] Mode	66
4-4-10	Displaying in Color Rendering Index Comparison [CRI Comp.] Mode	71
4-4-11	Displaying in CIE1931 (CIE1964) Comparison [CIE1931 (CIE1964) Comp.] Mode	75
4-4-12	Displaying in CIE1976 Comparison [CIE1976 Comp.] Mode	79
4-4-13	Displaying Setting [Setting] Screen	83
5.	Measuring Light Sources [Measurement Screen]	85
5-1	Measurement Method	85
5-2	Measurement in Ambient Light Mode	86
5-3	Measurement in Cordless Flash Mode	90
5-4	Measurement in Cord (PC) Flash Mode	94
5-5	Comparison Function (in Ambient Light Mode only)	98
5-6	When [Over] or [Under] is Displayed	102
5-6-1	Display of [Over] or [Under]	102
5-6-2	Changing the Light Range	103
6.	Measurement Tool [Tool Box] Screen	104
6-1	Setting Preset Contents [Preset Selection] Screen	105
6-2	Using the Memory Function	108
6-2-1	Naming Measurement Values Being Memorized [Memory Title] Screen	109
6-2-2	Recalling Measurement Results [Memory Recall] Screen	113
6-2-3	Renaming Memory Title [Memory Rename] Screen	118
6-2-4	Deleting Saved Measurement Results [Memory Clear] Screen	121

6-3	Selecting Exposure Time [Exposure Time] Screen	126
6-4	Setting the Shutter Speed [Shutter Speed] Screen	128
6-5	Selecting Measuring Method [Measuring Method] Screen	130
7. Meter Settings [Setting] Screen	133
7-1	Setting Items	133
7-1-1	Item List	135
7-2	Customize	136
7-2-1	Item Specifications	137
7-2-2	Selecting the Unit of Illuminance	138
7-2-3	Selecting the Spectrum Y-axis Scale	140
7-2-4	Selecting the Auto Power Off Time	143
7-2-5	Selecting the Backlight Brightness	145
7-2-6	Selecting the Auto Dimmer Time	147
7-2-7	Selecting the Language	149
7-2-8	Reset Customized Items	151
7-3	Preset Editing	152
7-3-1	Displaying the Preset Selection List	158
7-3-2	Setting the Present Name	160
7-3-3	Setting the Tcp	162
7-3-4	Setting the Δuv	164
7-3-5	Setting the Tristimulus Value Y	166
7-3-6	Setting the λp	168
7-3-7	Setting the CRI	170
7-3-8	Setting the value of CRI	172
7-3-9	Setting the PPFd	174
7-3-10	Setting the Rf	176
7-3-11	Setting the Rg	178
7-3-12	Setting the SSIt	180
7-3-13	Setting the SSId	182
7-3-14	Setting the TLCI	184
7-4	Dark Calibration	186
7-5	Product Information Display	189
7-6	Regulation Display	191

8. Hardware Setting Screen	192
8-1 Adjust Touch Panel	194
8-2 Edit User Information	197
8-3 Field of View	199
8-4 Factory Setting	201
9. Appendix	204
9-1 Glossary	204
9-2 Specifications	206
9-3 Legal Requirement	211
10. Optional Accessories	212
11. Troubleshooting	213
12. After-sales Services	215

1. Parts Designations and Functions

1-1 Parts Designations

Front View

Rear View

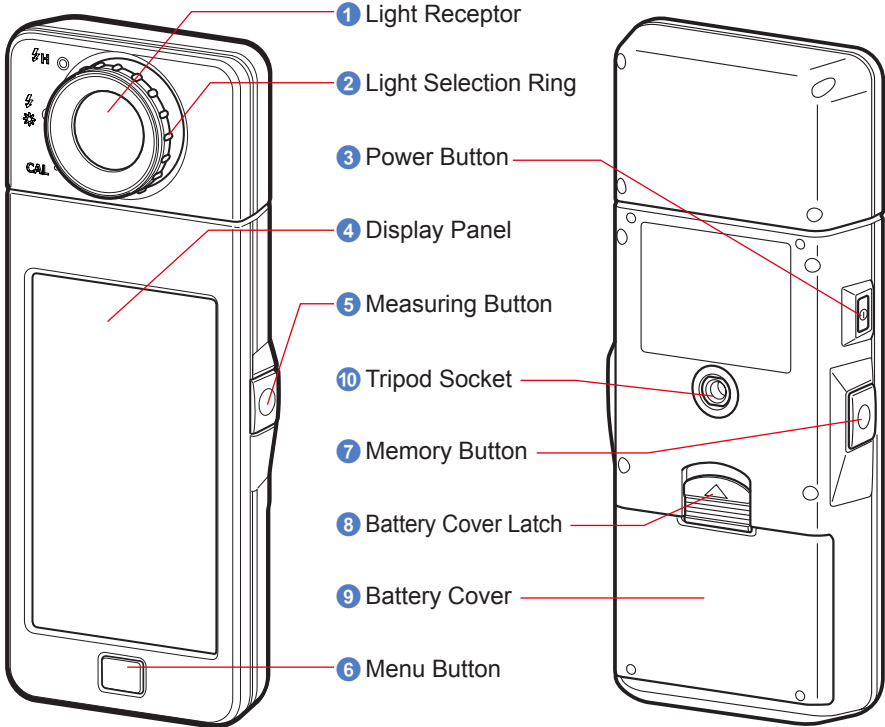

Bottom View

Battery Compartment Section

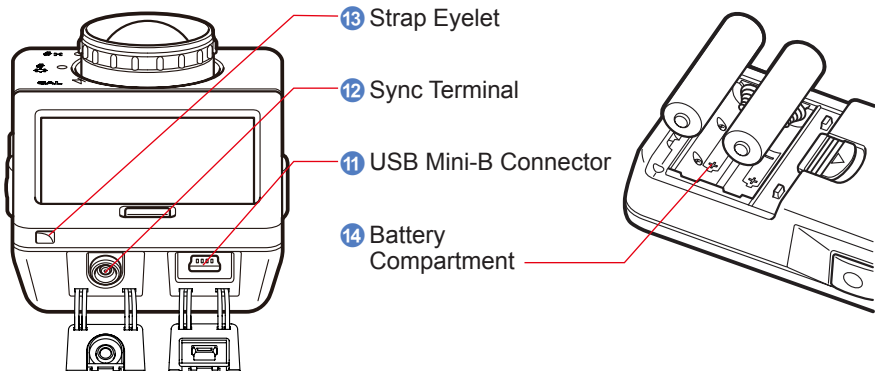

1-2 Parts Functions

The following table lists the functions of each part.

No.	Part Name	Functions
1	Light Receptor	Point light receptor directly at light source during reading. Head rotates 270 degrees to aid reading.
2	Light Selection Ring	Rotate to select dark calibration, normal measuring range or high range for flash light.
3	Power Button	Press to turn ON/OFF.
4	Display Panel	Displays the setting screens and measurement screens. The built-in touch panel function enables setting, selection or operation by touching the displayed screens. (➡ P17)
5	Measuring Button	Press for measurement.
6	Menu Button	Press to shift display to Display Mode Selection screen.
7	Memory Button	Press after measuring to save the measured data.
8	Battery Cover Latch	Latch for the battery cover.
9	Battery Cover	Secures the batteries.
10	Tripod Socket	Female mounting threads (1/4-20) for hands free mounting on tripods.
11	USB Mini-B Connector	The USB connector for connecting to the PC with the installed utility and USB bus power. USB terminal: Mini-B-5pin
12	Sync Terminal	Accepts an optional synchro cord when using meter in Cord (PC) Flash Mode.
13	Strap Eyelet	Used to attach the included strap.
14	Battery Compartment	Holds the batteries. Insert the batteries in the correct direction.

2. Before Use

2-1 Attaching the Strap

1. Pass the strap (included) through the outer hole of the Strap Eyelet **13**.
2. Pass the opposite end of the strap through the loop at the end of the strap.

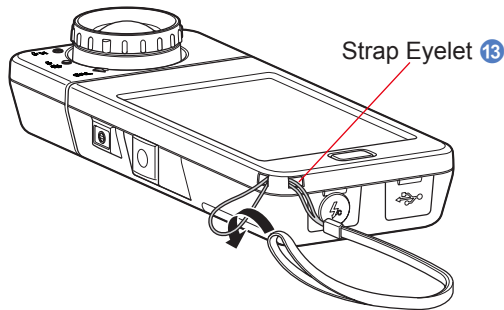

WARNING

Infants or toddlers may accidentally wrap the strap around their neck, so please place it in a location out of their reach. There is a danger of suffocation.

CAUTION

- Infants or toddlers may accidentally grab the strap and swing the product, so please place it in a location out of their reach, as the meter may be damaged by impacts.
- Be careful that the neck strap does not come loose when carrying the product, as the meter may be damaged when dropped.
- This neck strap is made of polyester fiber. Please refrain from using the product if synthetic fibers cause your skin to become irritated, inflamed or itchy in order to prevent worsening your symptoms.

2-2 Installing the Batteries

1. Prepare two AA batteries.
2. Slide the Battery Cover Latch **8** in the direction of the arrow and remove the Battery Cover **9**.
3. Insert the batteries according to the "+" and "-" symbols in the Battery Compartment **14**.

* As shown in the diagram below, please note both positive sides of the batteries are facing in the same direction.
4. While lining up the two tabs on the Battery Cover **9**, press the Battery Cover **9** back into place from above.

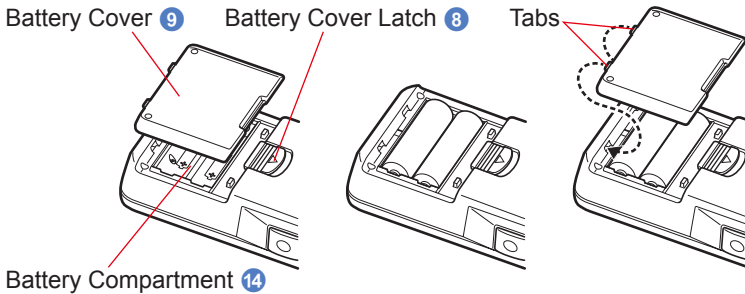

WARNING

Do not place batteries in open flames, attempt to short, disassemble, apply heat to, or recharge them (except rechargeable batteries). They may burst and cause fires, serious injury, or damage to the environment.



CAUTION

- Use the manganese or alkaline batteries.
- Do not use batteries with any other rating than the one specified. Also, do not mix old and new batteries.
- Please insert the batteries minus “-” side first. When removing the batteries, remove them plus “+” side first.
- If the meter will not be used for an extended period of time, it is recommended to remove the batteries to avoid possible damage caused by battery leaking.

2-3 Power ON/OFF

Power ON

1. Turn the Light Selection Ring **2** to set to the dark calibration position **CAL** ().
2. Press the Power Button **3**.

The meter will turn on and the Opening screen will be displayed (for 2 seconds).

Light Selection Ring **2**

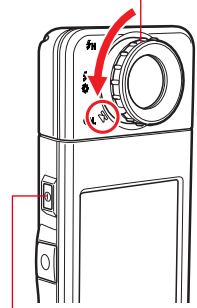

Power Button **3**

C-7000 Startup Screen



NOTICE

- The blue lettered "SEKONIC" logo screen is displayed after battery replacement and 24 hours after power OFF.
- Movement of the blue status bar indicates that the meter is checking its memory and preparing to operate. Do not turn the power OFF. Otherwise, the meter may be damaged.

Logo Screen



NOTE

- If the LCD screen shows no display, check if the batteries are installed properly (Pos/Neg positioning) and have enough capacity.
- You can reduce start up time by simply tapping the screen when the Startup screen appears.

3. Select the language. (Appears only when turned ON for the first time)

The Language Selection screen is displayed. Select the language to use.

Language Selection Screen



Language Selection Confirmation Screen



The selected button will be displayed encircled in blue.

4. Press the [OK] to select the language.

The language can be switched at any time. (➔ P149)

5. Dark calibration.

The C-7000 measuring system must be calibrated before use. Turn Light Selection Ring to calibration indication. "Dark calibration in progress. Please wait" and the status bar will appear while calibrating. The Display Mode Selection screen will appear when operational.

Dark Calibration Process Screen

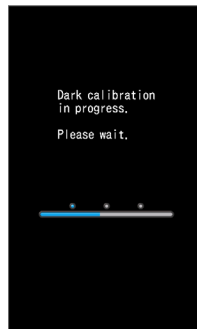

NOTE

- Dark calibration is performed when new batteries are used, 24 hours passed since last use or there is a big change in temperature between turning power OFF and ON. Except the cases above, dark calibration after power ON is skipped.

NOTICE

- When the Light Selection Ring ② is not set to the dark calibration position, the message "Please set Light Selection Ring for dark calibration." is displayed. Set the Light Selection Ring ② to the dark calibration position CAL () to calibrate the system.

Dark Calibration Position Confirmation Screen

- If dark calibration is not successful, "Dark calibration failed. Please check Light Selection Ring position." is displayed. Set the Light Selection Ring ② to the dark calibration position CAL () to calibrate the system.

Dark Calibration Confirmation Screen

6. Touch the icon to be displayed on the Display Mode Selection screen.

The display will switch to the selected measurement screen.

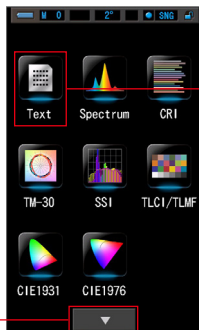









Display Mode Selection Screen

Measuring Screen

To page 2 

7. Press the Measuring Button ⑤ to measure.

Turn the Light Selection Ring ② to select the range.

When measuring ambient light, make sure to select Range L ().

When measuring flash units, select Range L () or Range H () depending on the brightness of the flash. ( ) ( ) ( ) ( )

NOTICE

- When the Measuring Button ⑤ is pressed at the dark calibration position, the message "Measurement failed. Please check Light Selection Ring position." is displayed. Set the Light Selection Ring ② to the correct position and the Measuring screen will be displayed.

**NOTE**

- Measurement and display will take longer in light levels below 30lx. The LCD illumination will normally switch off during measurement to avoid influence to measurement.

Power OFF

1. Press and hold the Power Button ③ for 1 second or longer.

The meter will turn OFF.

NOTICE

- Please wait 3 seconds between repeated power on and power off sessions.

NOTE

- All settings and measurements made during use are saved in memory even after the meter is powered off.

2-4 Automatic Power OFF Function

To save battery capacity, the meter will automatically turn off 5 minutes (factory setting) after the last button is pressed.

NOTE

- All measurements, settings and indications are saved in memory even after the meter has automatically turned off. When the power is turned ON, they will be displayed again.
- The default setting of Auto Power Off is 5 minutes. Other settings or "No auto power off" can be selected in the Customize of Setting screen. (➔ P143)
- If, while in transport, the Power Button **3** is inadvertently and continually pressed in, the meter will turn ON for about 1 minute and then turn automatically turn OFF to save battery power.

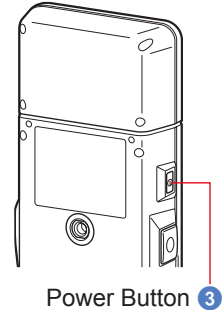

Power Button **3**

2-5 Checking the Battery Capacity

When the power is turned ON, the LCD screen will show the battery capacity indicator.



Sufficient battery life remaining.



Adequate battery life remaining.



Have a spare battery ready.



Replace the battery immediately.

Battery capacity indicator

Measuring Screen

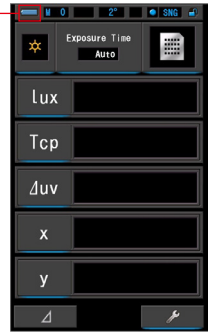

NOTE

- When battery power is low and the meter is turned ON, the LCD screen will appear and then turn off immediately. This is an indication that the batteries are depleted and should be replaced immediately.
Having spare batteries on hand is recommended.
- When the meter is continuously used at room temperature, the battery life should last 8 hours (based on Sekonic testing methods).

2-6**Automatic Power OFF Function**

- Always turn off the power before replacing batteries.
If you replace batteries while the power is turned on, the measured values that are obtained during operations are not saved. Also, this may cause a failure.
- If an unexpected display appears on the LCD during battery replacement or measurement, ie. settings other than selected, or if the meter does not respond when a button is pressed, remove the batteries, wait at least 10 seconds, and then re-install them.

3. Screen Operation

3-1 Screen and Operation

3-1-1 Basic Screen and Operation

The touch-screen display enables selecting Display Modes and settings with the touch of your finger.

Measuring Screen

When the dark calibration is complete, the Display Mode Selection screen is displayed. Select the desired display mode and the selected measurement screen is displayed. On the Measuring screen, it is possible to select the Measuring mode or change the measuring condition. Touch the icons with blue under-bar to change the setting. To change the Display Modes, refer to each explanation of Display Modes.

* Pressing the Menu Button **6** on the meter returns the meter to the Display Mode Selection screen.

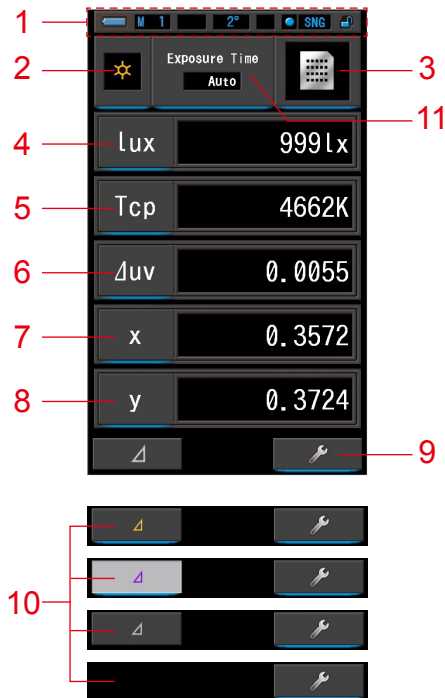

Measuring Screen in Text Mode



* The display changes depending on the set measuring mode.

* For this description, all icons and menus are displayed.

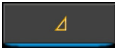
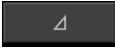
Item List

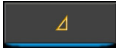
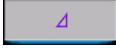
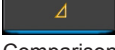
No.	Part Name	Description
1	Status Bar	Displays the setting contents. (➡ P14)
2	[Measuring Mode] Icon	Displays the current Measuring Mode. (➡ P23) Touch the icon to switch to the Measuring Mode Selection screen.
3	[Display Mode] Icon	Displays the current Display Mode. (➡ P30) Touch the icon to switch to the Display Mode Selection screen.
4 ~ 8	[Display Item] Indication	Touch the icon to switch to the Display Item Selection screen. (➡ P28)
9	[Tool Box] Icon	Switches to the Tool Box screen. (➡ P104)
10	[Delta] Icon (in Ambient Light Mode only)	 Displayed when comparison measurement can be performed.
		 When there is no reference preset value, the icon is disabled.
		 When comparison measurement cannot be performed, the (Δ) icon is not displayed.
		When  is touched, Comparison Function is activated. The preset value is shown in yellow letter when this delta icon is displayed. When holding the Measuring Button ⑤, the value differences of the preset value and the current reading being measured will be displayed. (The preset value is a value that has been preset in Customize of Setting screen.) When the Measuring Button ⑤ is released, the display will revert to the preset value. When  is touched, the icon returns to  and the values measured last are displayed. Comparison Function is cancelled when the power is turned OFF. Note: When the Comparison Function icon is displayed, the Memory Button ⑦ is disabled.
11	[Exposure Time] Indication	Switches to the Exposure Time Selection screen. (➡ P25)

 **NOTE**



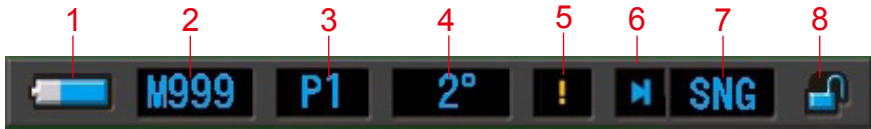

- When values are outside the display or measurement range, [Under] or [Over] is displayed.
- Under: Displayed if value is lower than measurement range (too dark) or color temperature value is too low.
- Over: Displayed if value is higher than measurement range (too bright) or color temperature value is too high.

Status Bar



* For this description, all icons and menus are displayed.

No.	Part Name	Description	
1	Battery Capacity Indicator		Sufficient battery life remaining.
			Adequate battery life remaining.
			Have a spare battery ready.
			Replace the battery immediately.
			Appears when powered by USB.
2	Memory Count		Displays the number of measured data stored in memory. The number in memory is displayed until 999 to the right of the mark.
3	Preset Selection		Displays the preset number when a preset is selected.
4	Field of view		Displays the viewing angle (2° or 10°) that was set when hardware was set.
5	Temperature Fluctuation Warning		When the mark appears, the referenced environment temperature is fluctuating, and accurate measurement may not be possible. Please perform dark calibration.
6	Light Selection Ring Status Indicator		Appears when the Light Selection Ring ② is selected by the dark calibration position.
			Appears when the Light Selection Ring ② has range "L" selected.
			Appears when the Light Selection Ring ② has range "H" selected.

No.	Part Name	Description	
7	Measuring Method		Appears when Single measurement is selected in Tool Box.
			Appears when Continuous measurement is selected in Tool Box (in ambient light only).
8	Key Lock Status Indicator		Appears when the screen is unlocked.
			Appears when the screen is locked. When the screen is locked, touch panel operations are disabled.

Tool Box Screen

The following setting can be performed after touching the [Tool Box ()] icon on the measuring screen.

* All icons are displayed for explanatory purposes for the Tool Box screen. It is not the default.

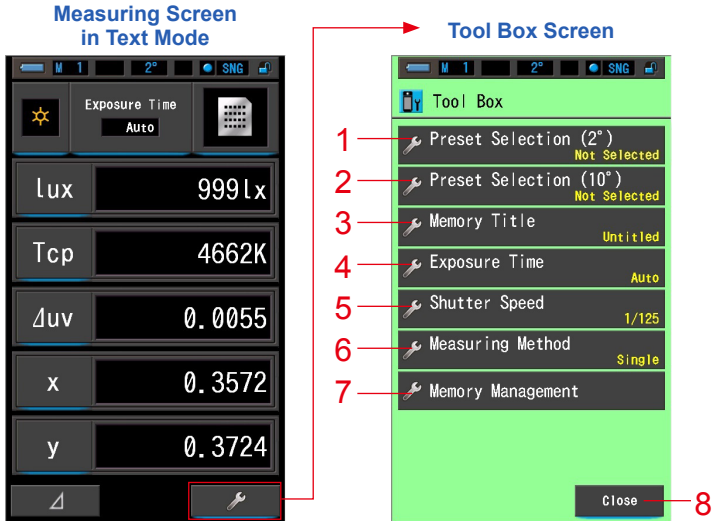

[Tool Box: Item List]

No.	Part Name	Description
1	Preset Selection (2°)	Switches to the Preset Selection screen. (➔ P105)
2	Preset Selection (10°)	Switches to the Preset Selection screen. (➔ P105)
3	Memory Title	Switches to the Memory Title Input screen. (➔ P109)
4	Exposure Time	Switches to the Exposure Time screen. (➔ P126)
5	Shutter Speed	Switches to the Shutter Speed screen. (➔ P128)
6	Measuring Method	Switches to the Measuring Method screen. (➔ P130)
7	Memory Management	Switches to the Memory Management screen. (➔ P113)
8	[Close] Button	Closes the Tool Box screen and returns to the Measurement screen.

3-1-2 Icon Operation

Touch Operation

Touch the icons on screen to perform various operations.

(Ex.) Measuring Screen in Text Mode

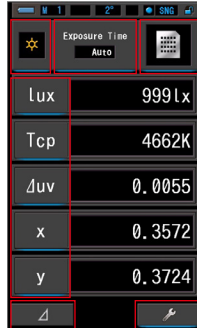

Touch-enabled Icons

Icons with blue under-bar indicate which icons are operational.

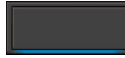

Touch-enabled Icons



Touch-disabled Icons

Slide Operation

Slide your finger tip up or down over a value to change the value amount. Sliding your finger over scroll bar provides fast navigation of large menus.

(Ex.) Shutter Speed Selection Screen

Scroll Selection
Slide a finger up or down on the setting value areas to change setting values.

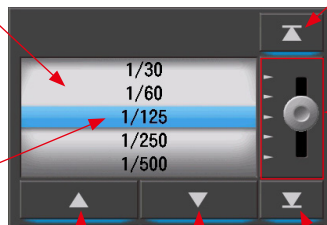

Top Icon
Touch to advance to the lowest value.

Scroll Bar
Touch and slide up or down to scroll settings.

One Step Icon
Touch the Up or Down icon to advance one position.

Bottom Icon
Touch to advance to the highest value.

* Blue bar indicates the value selected.

3-1-3 Input of Numbers/Characters

You can input numbers and characters.

Numeric Number Input Screen

(Ex.) Display of deviation Δuv

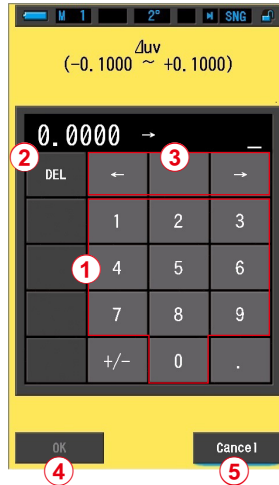

Numeric Number Method

No.	Key	Description
①	0-9, +/-, period	Enters a numeric value, plus or minus sign, and a period. When touched, the entry is displayed at the top of the screen.
②	Delete	Deletes input value at cursor position.
③	← →	Moves input position.
④	OK	Confirms input value and returns to previous screen.
⑤	Cancel	Cancels input value and returns to previous screen.

Character Input Screen

Figure Input Screen

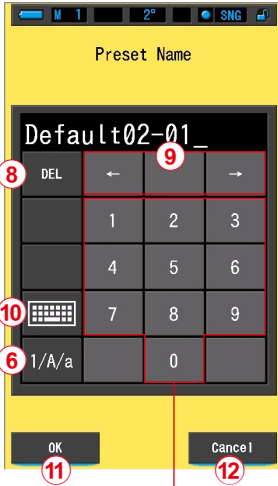

⑦ (Figures)

Upper Case Input Screen

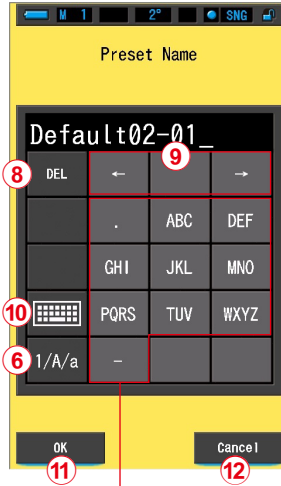

⑦ (Upper Case Letters)

Lower Case Input Screen

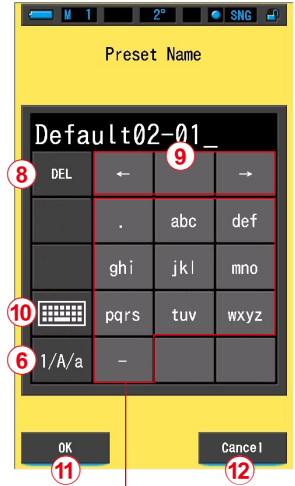

⑦ (Lower Case Letters)

Keypad (Upper Case Input Screen)

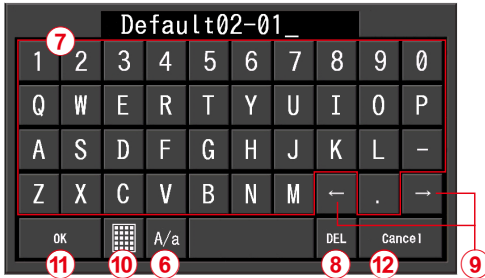

Keypad (Lower Case Input Screen)

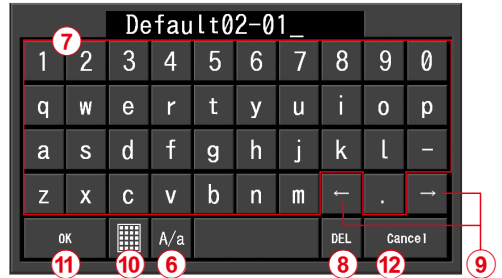

Input Method of Characters and Numbers

No.	Key	Description
⑥	1/A/a	Shifts between numbers/upper case letters/lower case letters.
⑦	0-9, ABC, abc, hyphen, period	Value displayed on screen when key touched. Repeated touching of the same button for alphabet (ABC/abc) will change the alphabet character in order.
⑧	Delete	Deletes the character at the cursored position.
⑨	← →	Moves input position.
⑩	Keypad	Shifts between Standard Keypad and Qwerty Keypad.
⑪	OK	Confirms input value and returns to previous screen.
⑫	Cancel	Cancels inputting and returns to previous screen.

3-1-4 Locking and Unlocking the Screen

You can lock the screen to prevent misoperation.

When the screen is locked, touch operation is disabled.

However, the Memory Button **7**, Measuring Button **5**, and Power Button **3** are still operational.

The screen will stay locked even when power is turned OFF and ON.

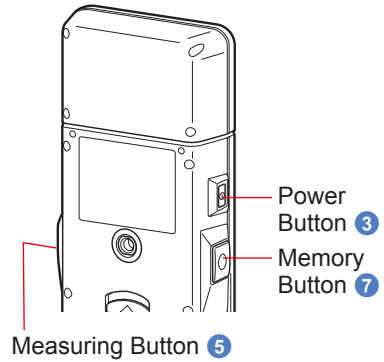

To Lock

In any measuring mode, press and hold the Menu Button **6** to see the Locked icon [] appear at the upper right corner of the LCD screen.

Function Icons cannot be operated while the screen is locked.



The Locked icon [] will appear for approximately 1 second at the center of the screen when function icons are touched or MENU button **6** is pressed.

* This lock function can be set in the Measuring screens only.

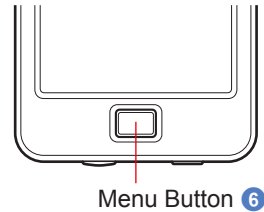

To Unlock

When the Menu Button **6** is pressed and held again, the screen is unlocked.

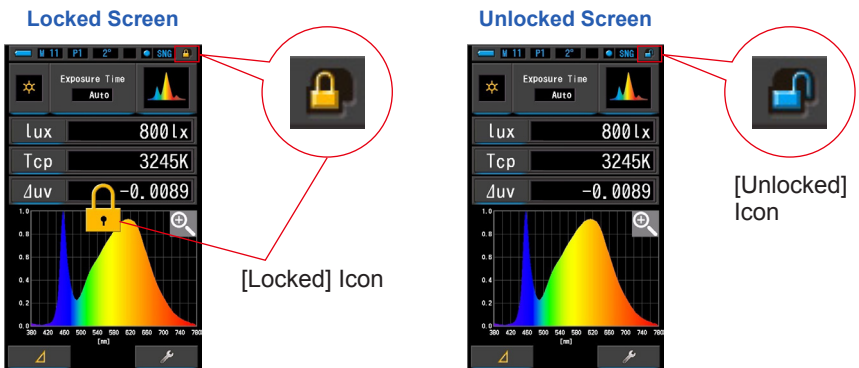

4. Basic Operations

4-1 Basic Measurement Flow

The basic operations and screens are as follows. Measurements and measurement changes are operated from the Measuring screen.

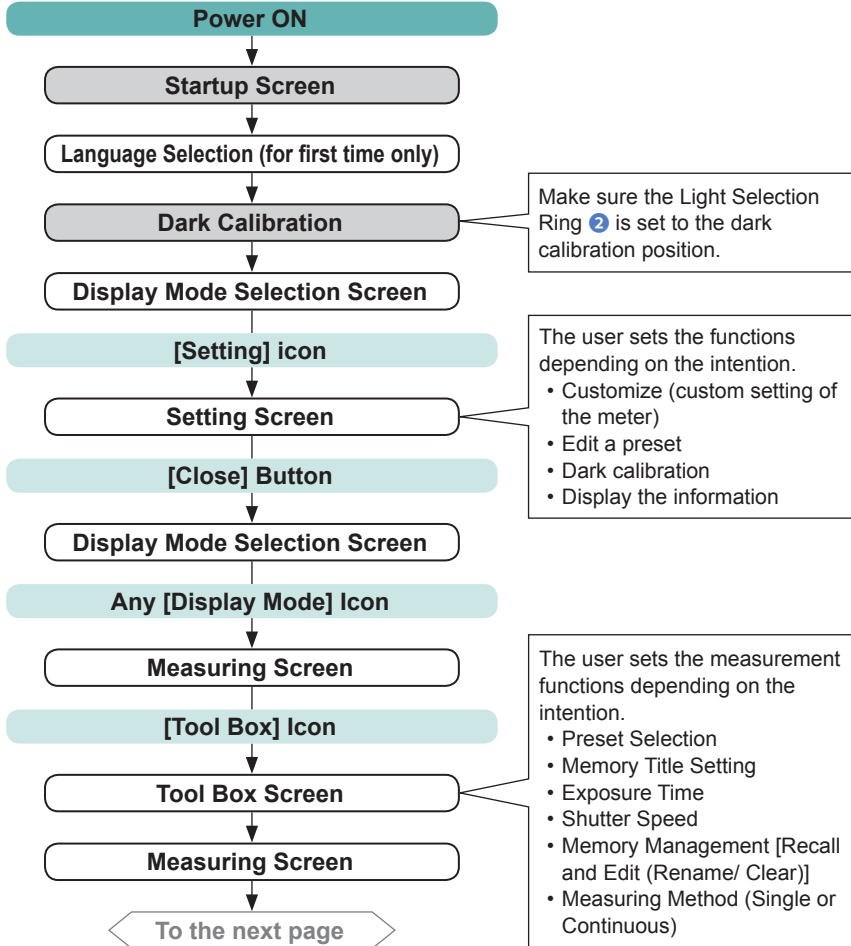

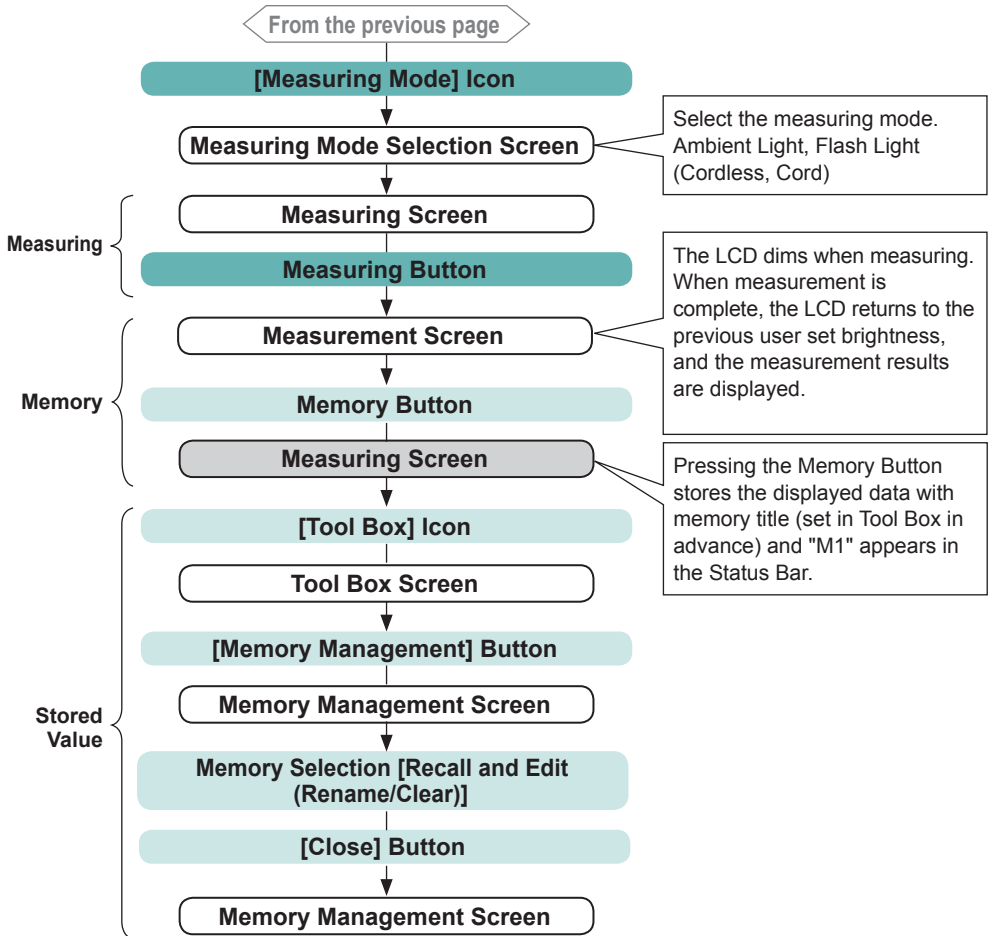

4-2 Selecting the Measuring Mode

4-2-1 Matching Measuring Mode with Light Sources

Select the Measuring Mode to use.





NOTICE

- If you change the Measuring Mode, the currently displayed measurement is cleared.

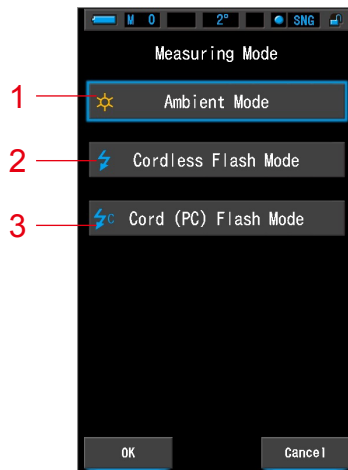
Measuring Mode Selection Screen



No.	Measuring Mode	Icon	Description
1	Ambient Light Mode		Measures continuous light such as sunlight, tungsten, fluorescent, and LED lights. (➔ P86)
2	Cordless Flash Mode		Detects flash light without meter-flash connection after Measuring Button pressed to arm meter (for 90 seconds) and flash fired separately. (➔ P90)
3	Cord (PC) Flash Mode		Detects flash light with PC (synchro) cord meter-flash connection. (➔ P94)

Operation

1. Touch the [Measuring Mode] icon in the upper left corner of the screen.
The Measuring Mode Selection screen will be displayed.

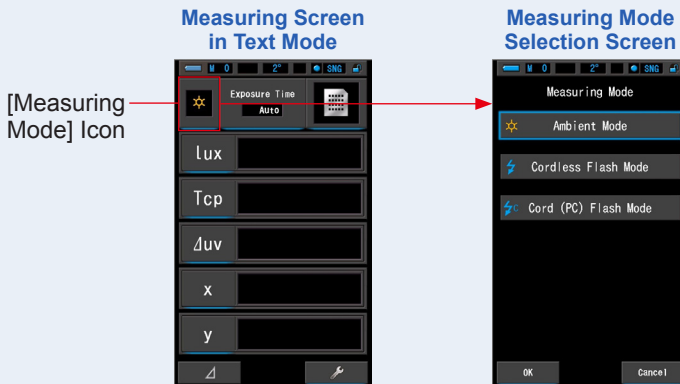

2. Touch an icon to select the measuring mode.
Select the desired measuring mode.

3. Touch the [OK] button.

Confirms the settings, and returns to the previous Measurement screen.

Touch [Cancel] to return to the previous measurement screen without setting.

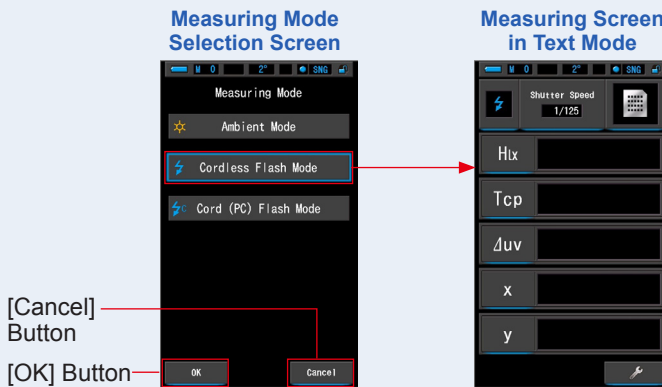

Ex.) Ambient Light Mode → Cordless Mode



NOTE

- Ambient light includes continuous light sources such as natural light (sunlight), tungsten lamps, fluorescent lamps, LED lights, etc.
- Flash light includes brief and intense burst of light sources such as electronic flash units or flash bulbs.

4-2-2 Selecting the Exposure Time (Ambient Modes Only)

Set a Exposure Time for ambient measurement.

Operation

1. Touch the [Exposure Time] indication on the Measuring screen.

Touch the [Auto], [0.1 sec] or [1.0 sec] button.

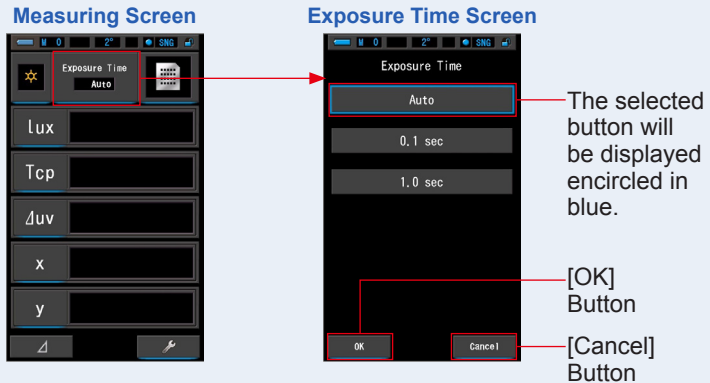

2. Touch the [OK] button.

Confirms the settings, and returns to the previous Measuring screen.

Touch [Cancel] to return to the previous Measuring screen without setting.

Exposure time is set.

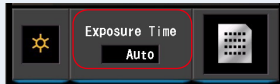

NOTE

- In Auto mode, the C-7000 automatically selects among 15 measuring times, determined by the illumination available, to achieve a proper result in a convenient way.
- Two fixed reading times are available to enable exact comparison of multiple measurements.
- When measuring high illuminance levels, set the Exposure Time to 0.1 sec.
- When taking measurements in low illuminance, set the Exposure time for 1.0 sec.

NOTICE

- 0.1 sec and 1.0 sec may not cover some measurement range of illumination and [OVER] or [UNDER] appears. In this case, set Exposure time to "Auto".

4-2-3

Selecting the Shutter Speed (Flash Modes Only)

Set a shutter speed that is appropriate for the intended flash measurement.

Operation

1. Touch the [T (Shutter Speed)] indication.

(Ex.) Cordless Flash Mode Measuring Screen in Text Mode

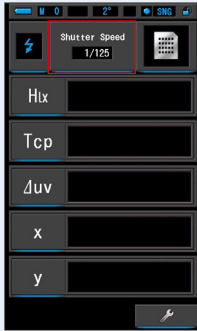

2. Select the desired shutter speed.

Shutter Speed Screen

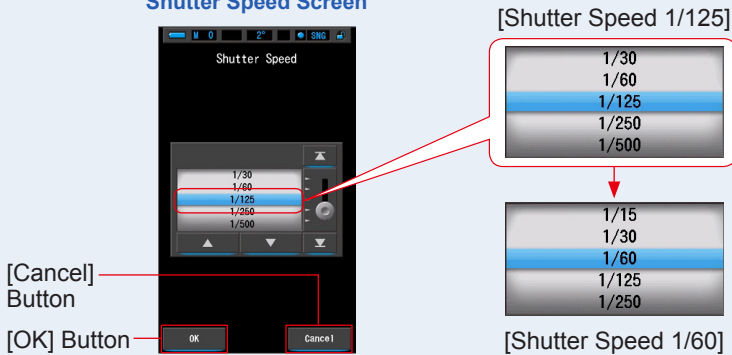

3. Touch the [OK] button.

Confirms the settings, and returns to the previous Measurement screen.

To cancel the setting, touch the [Cancel] button.

The shutter speed is set.

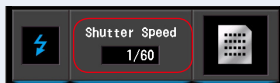

**NOTE****Shutter Speed Options**

1 Step
1s
1/2
1/4
1/8
1/15
1/30
1/60
1/125
1/250
1/500

**NOTICE**

- Measuring data will be erased when the shutter speed setting is changed.

4-3

Customizing Measuring Displays

You can customize displayed information to see exactly what you need in single view.

Operation



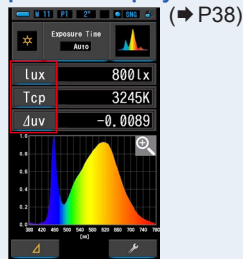
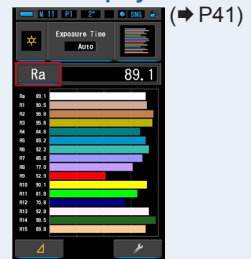







1. Touch the [Display Item] indication on the Measuring screen.
The Display item library screen will be displayed. (⇒ P36)
2. Select the items to be displayed.
Selected items and the values will be displayed.

Measuring Screen
Text DisplayMeasuring Screen
Spectrum DisplayMeasuring Screen
CRI Display

Display Item List

Field of view No.	2°	10°	Name	Description
	Icon	Icon		
1	Tcp		Correlated Color temperature	Displays the color temperature.
2	Δuv		Deviation	Displays a deviation from the black body radiation.
3	X	X ₁₀	Tristimulus value	Displays tristimulus value X or X ₁₀ .
4	Y	Y ₁₀		Displays tristimulus value Y or Y ₁₀ .
5	Z	Z ₁₀		Displays tristimulus value Z or Z ₁₀ .
6	x	X ₁₀	Chromaticity coordinates	Displays CIE1931 chromaticity coordinates x, or CIE1964 chromaticity coordinates X ₁₀ .
7	y	y ₁₀		Displays CIE1931 chromaticity coordinates y, or CIE1964 chromaticity coordinates y ₁₀ .
8	z	Z ₁₀		Displays CIE1931 chromaticity coordinates z, or CIE1964 chromaticity coordinates z ₁₀ .
9	u'	u' ₁₀		Displays CIE1976 chromaticity coordinates u' or u' ₁₀ .
10	v'	v' ₁₀		Displays CIE1976 chromaticity coordinates v' or v' ₁₀ .
11	λd	λd ₁₀	Dominant wavelength	Displays the dominant wavelength or the complementary wavelength (if the measurement value is negative).
12	Pe	Pe ₁₀	Excitation purity	Displays the excitation purity.
13	λp		Peak wavelength	Displays the peak wavelength.
14	lux	Hlux	Illuminance / luminous exposure	Displays the illuminance or luminous exposure. It can be set on this spectrometer.
15	fc	Hfc		

* Models sold in some countries do not display illuminance and exposure in "fc (fc·s)" due to legal restrictions

Field of view No.	2°	10°	Name	Description
	Icon			
16			Fidelity Index	Displays the Fidelity index of TM-30-18 in the value from 0 to 100.
17			Gamut Index	Displays the Gamut index of TM-30-18 in the value from 0 to 200.
18			SSI Tungsten	Displays the SSI index in the value from 0 to 100 in comparison with CIE Tungsten (3200K).
19			SSI Daylight	Displays the SSI index in the value from 0 to 100 in comparison with CIE D55 (5500K).
20			SSI #1	Displays the SSI index in the value from 0 to 100 in comparison with #1 selected light source (yellow graph) in SSI mode.
21			SSI #2	Displays the SSI index in the value from 0 to 100 in comparison with #2 selected light source (red graph) in SSI mode.
22			TLCI	Displays the TLCI index in the value from 0 to 100.
23			TLMF	Displays the TLMF index in the value from 0 to 100 in comparison with selected memorized value.
24			Average Color Rendering Index	Displays the average CRI of R1 to R8.
25			Special Color Rendering Index	Displays the CRI of R1 to R15.
26			Photosynthetic photon flux density	Displays the PPFD.

4-4

Selecting the Display Mode

Touching an icon on the Display Mode Selection screen displays lighting information in different ways to suit your needs.

* Pressing the Menu Button **6** on the meter returns to the Display Mode Selection screen.

Display Mode Icons List

Display Mode Selection
Screen (2°)
Page 1



Display Mode Selection
Screen (2°)
Page 2



Display Mode Selection
Screen (10°)
Page 1



Display Mode Selection
Screen (10°)
Page 2



1 Text



2 Spectrum

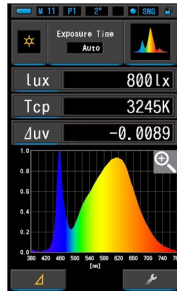

3 CRI

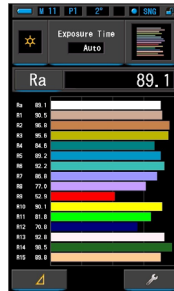

4 TM-30



5 SSI

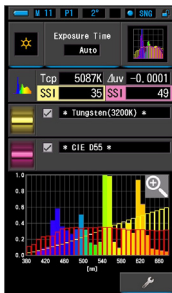

6 TLCI/TLMF

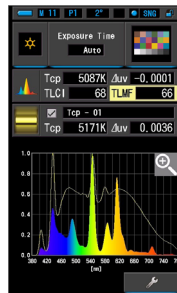

7 CIE1931 (CIE1964)

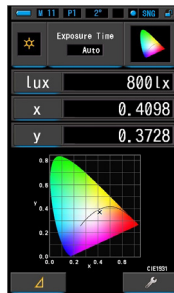

8 CIE1976

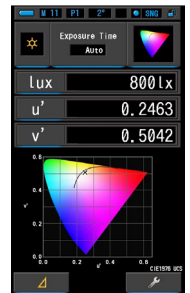

9 Spectrum Comparison

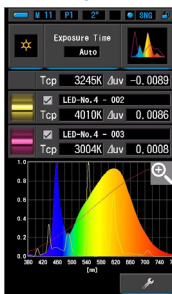

10 CRI Comparison

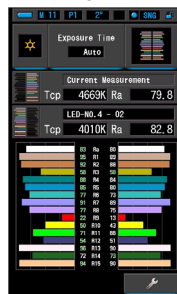

11 CIE1931 (CIE1964) Comparison

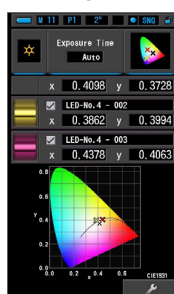



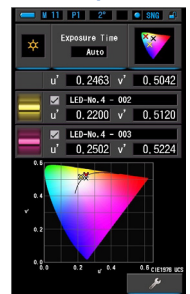



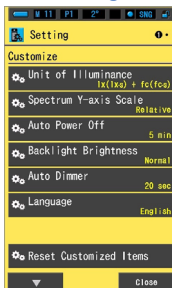





12 CIE1976 Comparison



13 Setting



No.	Icon	Display Mode Name	Description
1	 Text	[Text] Icon	Displays user-selected 5 items in numeric values. (➔ P35)
2	 Spectrum	[Spectrum] Icon	Displays 3 user-selected values and spectrum distribution graph. (➔ P38)
3	 CRI	[CRI] Icon	Displays the selected average CRI (Ra) or individual CRI (R1 ~ R15) numerically. Each CRI is displayed in a bar graph. (➔ P41)
4	 TM-30	[TM-30] Icon	Displays four current measurement values (Rf, Rg, Tcp, Δuv) and color vector graphic. (➔ P44)
5	 SSI	[SSI] Icon	Compares the current measurement value and up to 2 reference values (color temperature and Δuv), and displays SSI index with the SSI spectrum graph. (➔ P46)
6	 TLCI/TLMF	[TLCI/TLMF] Icon	Displays the current measurement values and memorized values (in color temperature and Δuv), TLCI and TLMF with spectrum graph. (➔ P57)
7	 CIE1931 CIE1964	[CIE1931 (CIE1964)] Icon	Displays the preset data together with the CIE1931 chromaticity diagram (or CIE1964 chromaticity diagram for a 10° viewing angle). (➔ P62)
8	 CIE1976	[CIE1976] Icon	Displays the measurement result together with the CIE1976 chromaticity diagram. (➔ P64)
9	 Spectrum Comp.	[Spectrum Comparison] Icon	Compares the current measurement value and up to 2 memorized values in the spectrum distribution graph. (➔ P66)
10	 CRI Comp.	[CRI Comparison] Icon	Compares the current measurement value and memorized value to show the color temperature and average CRI (Ra). Also, individual CRI (R1 to R15) is displayed in a graph. (➔ P71)
11	 CIE1931 Comp. CIE1964 Comp.	[CIE1931 (CIE1964) Comparison] Icon	Displays the preset data and the stored measurement value (up to 2 types of data) together with the x and y coordinates in the CIE1931 chromaticity diagram (or CIE1964 chromaticity diagram for a 10° viewing angle). (➔ P75)

No.	Icon	Display Mode Name	Description
12		[CIE1976 Comparison] Icon	Displays the measured result and the stored measurement value (up to 2 types of data) together with the u' and v' coordinates on the CIE1976 chromaticity diagram. (➔ P79)
13		[Setting] Icon	Displays Setting screen. (➔ P83)

* 1 ~ 12 are the Measurement screen.

Operation

1. Touch the [Display Mode] icon on the Measuring screen or press Menu Button **6** on the meter.

The Display Mode Selection screen will be displayed. (➔ P30)

Display modes from No.1 to 12 are for measurement.

Display mode No.13 is for settings.

2. Touch a desired Display Mode icon to display.

The Measuring screen in selected Display Mode appears on the screen.

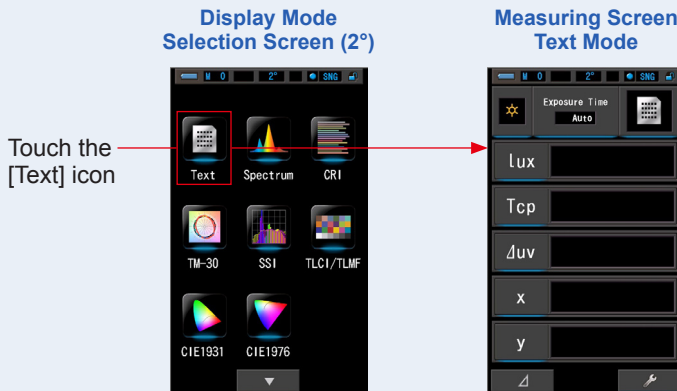

3. Touch the [Exposure Time] indication or [T (Shutter Speed)] indication on the Measuring screen.

For ambient light measurement, select the [Auto], [0.1 sec] or [1.0 sec] button. (➔ P25)

For flash light measurement, select the desired shutter speed. (➔ P26)

4. Press the Measuring Button 5 to measure.

The Light Selection Ring 2 should be set to L (⚡ (☀️)) when taking ambient light measurements.

When measuring flash units, select Range L (⚡ (☀️)) or Range H (⚡H (☀️)) depending on the brightness of the flash. (➔ P102, ➔ P103)

Measurements are now displayed.

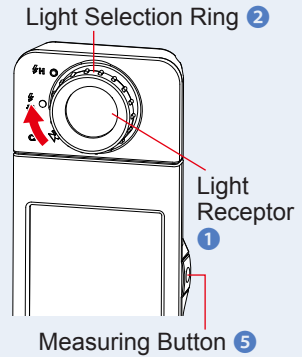

NOTE

- To measure the color temperature of a light source properly, point Light Receptor 1 directly at light source during reading.
- Measurements and display will take longer in light levels below 30lx. The LCD illumination will normally switch off during measurements to avoid influence to measurements.

5. Measurement result appears on the Measuring screen (Text Mode).

Measuring Screen in Text Mode



Measurement result

6. Memorize the measurement results.

To record measurements, press Memory Button 7. (➔ P108)

4-4-1 Displaying in Text [Text] Mode

Displays five user-selected items in numeric value.

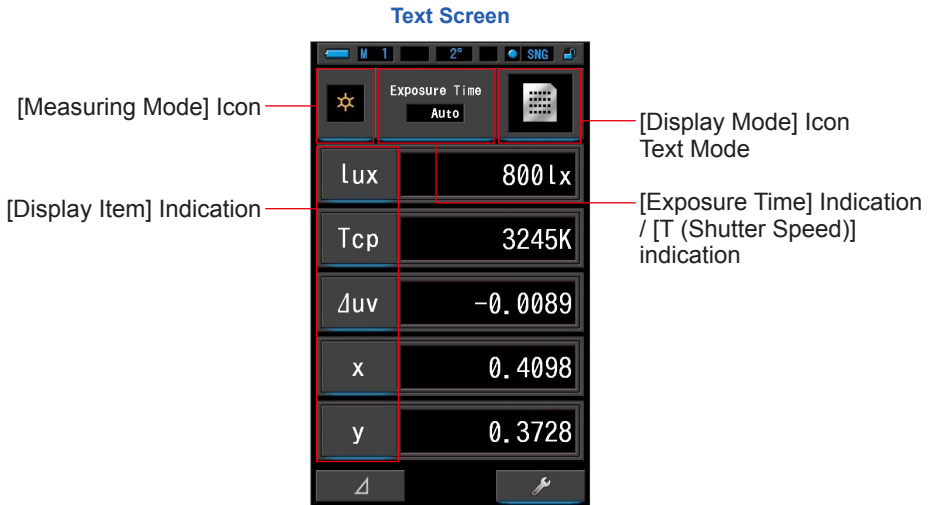

Operation

1. Touch the [Text] icon on the Display Mode Selection screen.
A Text screen will be displayed. (⇒ P30)
2. Touch the [Measuring Mode] icon.
The Measuring Mode Selection screen will be displayed. Select the desired measuring mode to use. (⇒ P23)
3. Touch the [Display Item] indication to change.
The Display item library screen will be displayed.
The currently selected display item will be encircled in blue.

4. Touch the desired Display Item indication and [OK] button.

The currently selected display item will be encircled in blue.

Pressing [OK] button confirms the settings, and returns to the Measuring screen. To cancel the setting, touch the [Cancel] button.

Text Screen

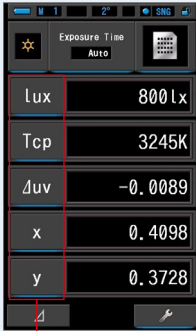

Touch [Display Item] indication you want to change.

Display Item Library Screen

In Ambient Light Mode Page 1

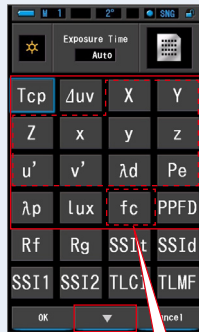

When "fc" is selected

fc

In Flash Light Mode Page 1

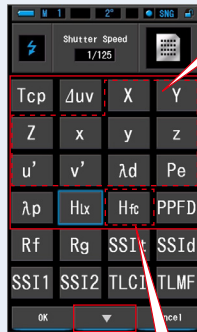

When "fc-s" is selected

Hfc

For a 10° viewing angle

	X ₁₀	Y ₁₀	
Z ₁₀	X ₁₀	y ₁₀	Z ₁₀
u' ₁₀	v' ₁₀	λd ₁₀	Pe ₁₀

In Both Modes Page 2

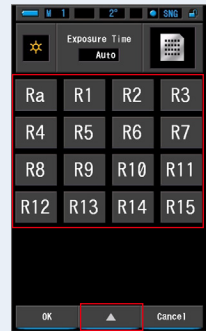

To page 2

To page 1

Touch the desired Display Item.

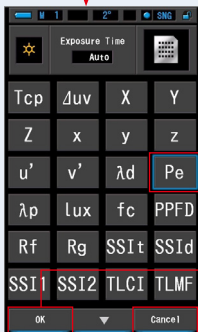

Indication will be encircled in blue.

[OK] Button

[Cancel] Button

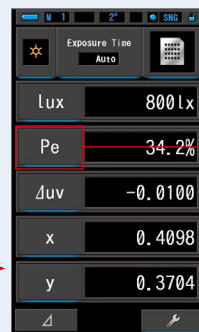

New Display Item appears.



* Models sold in some countries do not display "fc (fc-s)" due to legal restrictions.

5. Touch the [Exposure Time] indication or [T (Shutter Speed)] indication on the Measuring screen.

For ambient light measurement, select the [Auto], [0.1 sec] or [1.0 sec] button. (→ P25)
For flash light measurement, select the desired shutter speed. (→ P26)

6. Press the Measuring Button 5 to measure.

The Light Selection Ring 2 should be set to L () when taking ambient light measurements.

When measuring flash units, select Range L () or Range H () depending on the brightness of the flash. (→ P102, → P103)

Measurements are now displayed.

Light Selection Ring 2

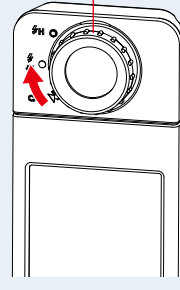

Measuring Button 5

NOTE

- Measurement and display will take longer in light levels below 30lx.
The LCD illumination will normally switch off during measurement to avoid influence to measurement.

7. Memorize the measurement results.

To record measurements, press Memory Button 7. (→ P108)

4-4-2 Displaying in Spectrum Graph [Spectrum] Mode

Displays three user-selected values and spectral distribution graph.

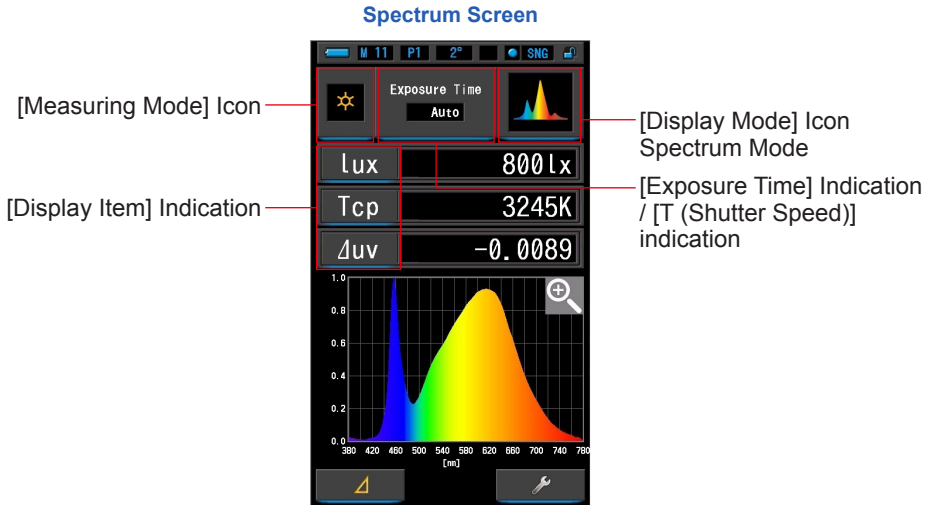

Operation

1. Touch the [Spectrum] icon on the Display Mode Selection screen.

A spectrum distribution graph screen will be displayed. (➔ P30)

2. Touch the [Measuring Mode] icon.

The Measuring Mode Selection screen will be displayed. Select the desired measuring mode to use. (➔ P23)

3. Touch the [Display Item] indication to change.

The Display item library screen will be displayed. (➔ P36)

Touch the desired Display Item and [OK] button.



4. Touch the [Exposure Time] indication or [T (Shutter Speed)] indication on the Measuring screen.

For ambient light measurement, select the [Auto], [0.1 sec] or [1.0 sec] button. (➔ P25)

For flash light measurement, select the desired shutter speed. (➔ P26)

5. Press the Measuring Button 5 to measure.

The Light Selection Ring 2 should be set to L () when taking ambient light measurements.

When measuring flash units, select Range L () or Range H () depending on the brightness of the flash. (→ P102, → P103)

Measurements are now displayed.

Light Selection Ring 2

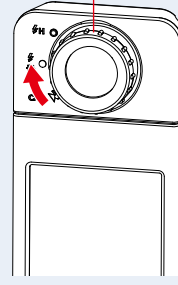

Measuring Button 5



NOTE

- Measurement and display will take longer in light levels below 30lx. The LCD illumination will normally switch off during measurement to avoid influence to measurement.

6. Touch the [Magnifying Glass (+)] icon on the screen.

The spectrum distribution graph will be enlarged.

The enlarged graph is displayed on the whole screen (landscape).

To return to the Spectrum screen, touch the [Magnifying Glass (-)] icon on the enlarged spectrum distribution graph.

Spectrum Screen

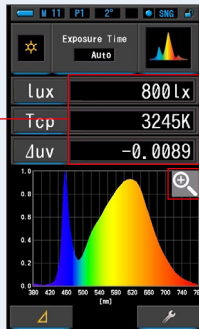

Spectrum Distribution Graph Enlarged Display

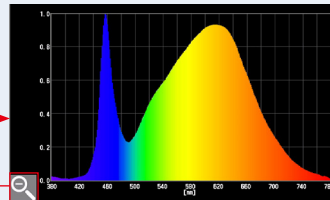

NOTICE

- When the enlarged graph is displayed, measurement cannot be performed.

**NOTE**

- The maximum display value of the Y-axis can be selected by the item [Spectrum Y-axis Scale] icon in page 1 of Setting. (➔ P140)

7. Memorize the measurement results.

To record measurements, press Memory Button **7** . (➔ P108)

4-4-3 Displaying in Color Rendering Index [CRI] Mode

Displays the selected average CRI (Ra) or individual CRI (R1 ~ R15) numerically. Each CRI is also displayed in a graph.

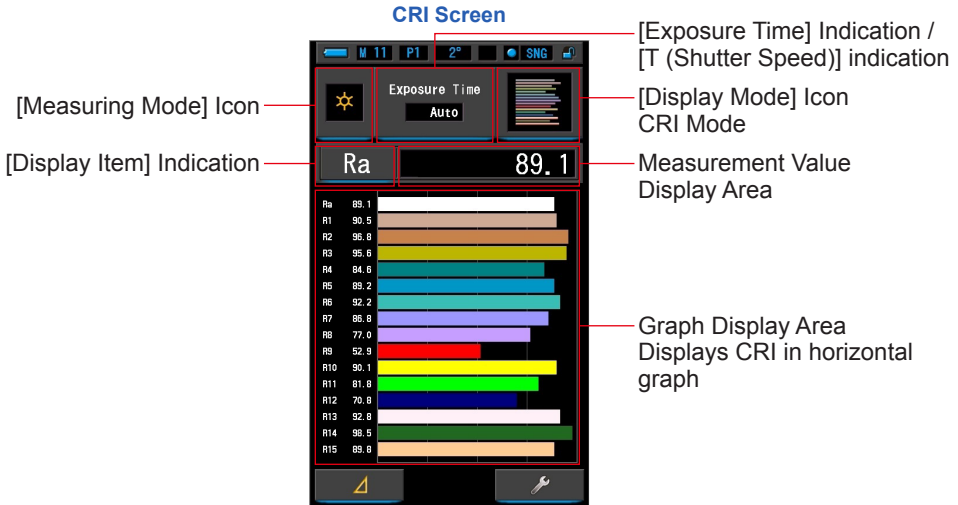

Operation

1. Touch the [CRI] icon on the Display Mode Selection screen.

The CRI screen will be displayed. (➔ P30)

2. Touch the [Measuring Mode] icon.

The Measuring Mode Selection screen will be displayed. Select the desired measuring mode to use. (➔ P23)



3. Touch the [Exposure Time] indication or [T (Shutter Speed)] indication on the Measuring screen.

For ambient light measurement, select the [Auto], [0.1 sec] or [1.0 sec] button. (➔ P25)

For flash light measurement, select the desired shutter speed. (➔ P26)

4. Press the Measuring Button ⑤ to measure.

The Light Selection Ring ② should be set to L () when taking ambient light measurements.

When measuring flash units, select Range L () or Range H () depending on the brightness of the flash. (➔ P102, ➔ P103)

Measurements are now displayed.

Light Selection Ring ②

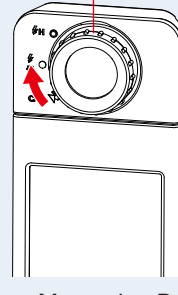

Measuring Button ⑤



NOTE

- Graph display areas Ra, R1 ~ R15 are always displayed.
- Measurement and display will take longer in light levels below 30lx. The LCD illumination will normally switch off during measurement to avoid influence to measurement.
- Ra is the averaged value from R1 to R8 only. R9 to R15 are not included in the Ra.

5. Touch the [Display Item] indication to change.

The Display Item Library screen will be displayed.

CRI Screen

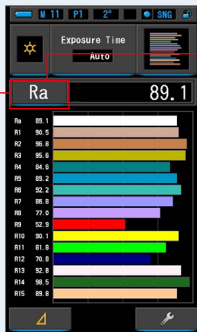

[Display Item]
Indication

Display Item Library

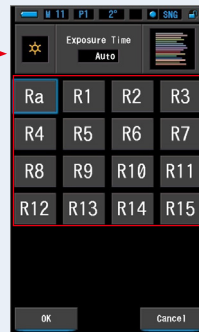

6. Touch the desired Display Item.

Select the item to display above the graph.
Indication will be encircled in blue.

7. Touch the [OK] button.

To cancel the setting, touch the [Cancel] button.

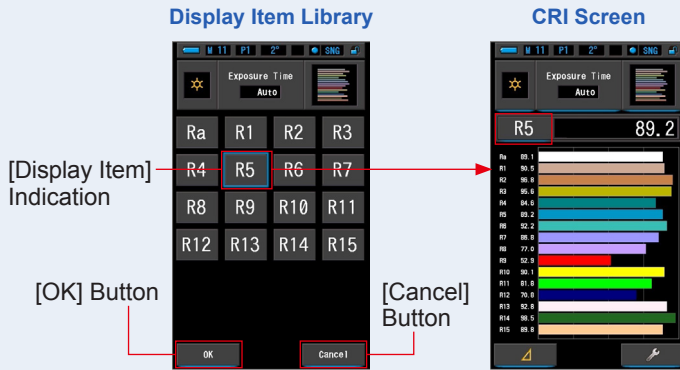

8. Touch the [OK] button.

To record only current measurements, press Memory Button ⑦ . (→ P108)

4-4-4 Displaying in TM-30 [TM-30] Mode

Displays four current measurement values (Rf, Rg, Tcp, Δuv) and color vector graphic.
(➔ P204)

The C-7000 with latest firmware shows TM-30-18.

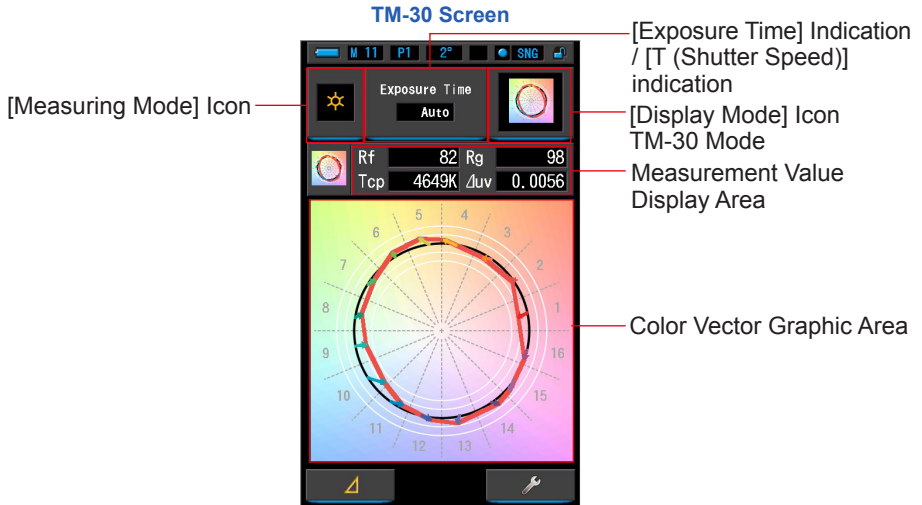

Operation

1. Touch the [TM-30] icon on the Display Mode Selection screen.

A TM-30 distribution graph screen will be displayed. (➔ P30)

2. Touch the [Measuring Mode] icon.

The Measuring Mode Selection screen will be displayed. Select the desired measuring mode to use. (➔ P23)



3. Touch the [Exposure Time] indication or [T (Shutter Speed)] indication on the Measuring screen.

For ambient light measurement, select the [Auto], [0.1 sec] or [1.0 sec] button. (➔ P25)

For flash light measurement, select the desired shutter speed. (➔ P26)

4. Press the Measuring Button ⑤ to measure.

The Light Selection Ring ② should be set to L () when taking ambient light measurements.

When measuring flash units, select Range L () or Range H () depending on the brightness of the flash. (➔ P102, ➔ P103)

Measurements are now displayed.

Light Selection Ring ②

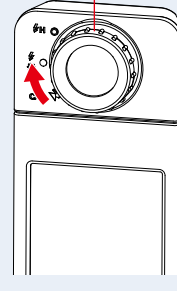

Measuring Button ⑤



NOTE

- Measurements and display will take longer in light levels below 30lx. The LCD illumination will normally switch off during measurements to avoid influence to measurements.

5. Current measurements and color vector graphic are displayed.

Default Display Items are Rf, Rg and Tcp, Δuv .

Color vector graphic is the visual representation of hue and chroma shifts around the hue circle divided by 16.

Color vector graphic shows the current measurement in the red line.

The standard light source is displayed in black slid line, and arrow shows the difference for current measurement.

White circles with radius shows Rg80, 90, 110 and 120.

Numbers from 1 to 16 represent hue-angle bins divided by 16 in 22.5 degree increment, which assign from 1 of red to 16 of reddish purple.

TM-30 Screen



Measurement Value Display

Color Vector Graphic Display

6. Memorize the measurement results.

To record measurements, press Memory Button ⑦. (➔ P108)

4-4-5 Displaying in Spectral Similarity Index [SSI] Mode

Compares the current measurement value and up to 2 reference values (color temperature and Δuv), and displays SSI index with the SSI spectrum graph. Reference light source can be set in three ways from standard illuminant, color temperature input or memory recall. (➔ P205)

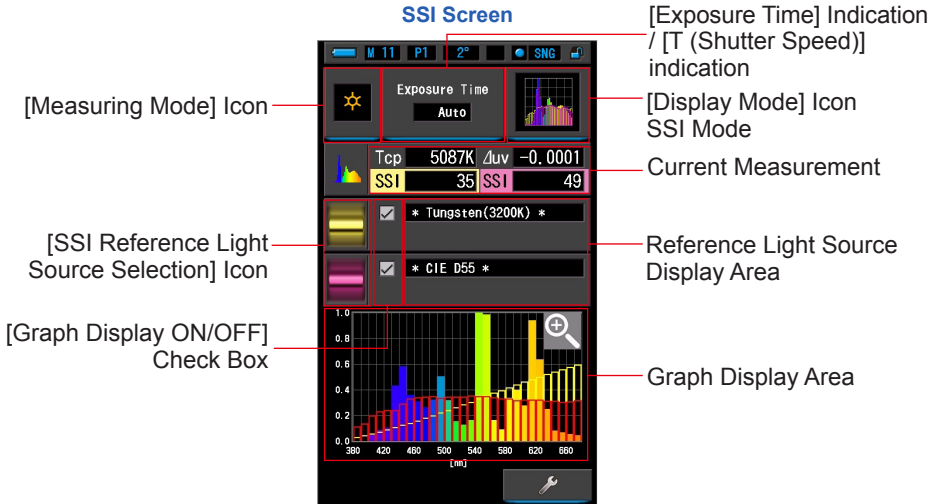

Operation

1. Touch the [SSI] icon on the Display Mode Selection screen.

The SSI screen will be displayed. (➔ P30)

2. Touch the [Measuring Mode] icon.

The Measuring Mode Selection screen will be displayed. Select the desired measuring mode to use. (➔ P23)

3. Touch the [Exposure Time] indication or [T (Shutter Speed)] indication on the Measuring screen.

For ambient light measurement, select the [Auto], [0.1 sec] or [1.0 sec] button. (➔ P25)

For flash light measurement, select the desired shutter speed. (➔ P26)

4. Press the Measuring Button ⑤ to measure.

The Light Selection Ring ② should be set to L (⚡ (☀️)) when taking ambient light measurements.

When measuring flash units, select Range L (⚡ (☀️)) or Range H (⚡H (☀️)) depending on the brightness of the flash. (➡ P102, ➡ P103)

Measurements are now displayed.

Light Selection Ring ②

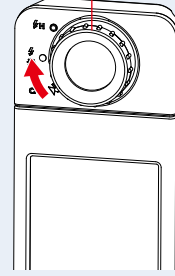

Measuring Button ⑤



NOTE

- Measurements and display will take longer in light levels below 30lx. The LCD illumination will normally switch off during measurements to avoid influence to measurements.

5. The current measurement is displayed in the graph display area.

6. Touch the [Select SSI Reference] icon.

The [Select SSI Reference Light] screen will be displayed.

SSI Screen

[Select SSI Reference] Icon

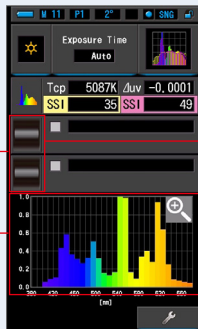

Current Measurement Graph (SSI)

Select SSI Reference Light Screen

Blue bar indicates the item selected.

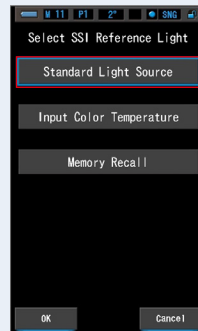

7. There are three ways to select the [Select SSI Reference Light].

Select the item to compare from three options; [Select SSI Standard Light Source], [Input SSI Color Temperature] and [SSI Memory Recall].

Select SSI Standard Light Source Screen

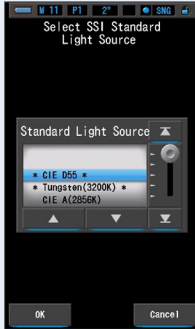

Input SSI Color Temperature Screen



SSI Memory Recall Screen

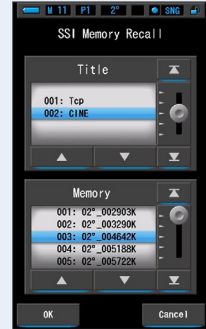

[Standard Light Source Selection]

You can select the reference light source from standard illuminants.

There are [Tungsten 3200K] and supplementary standard illuminant [CIE D55] as the SSI standard light source, [CIE A(2856K)] and [CIE D65] as CIE standard illuminant, and [CIE D50] and [CIE D75] as the CIE supplementary standard illuminant.

1. Touch the [Standard Light Source] indication on the Select SSI Reference Light screen.

The Select SSI Standard Light Source screen will be displayed.

Select SSI Reference Light Screen

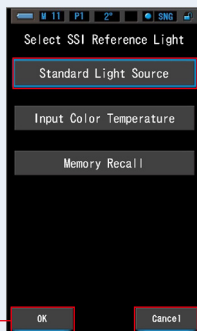

[OK] Button

[Cancel] Button

Select SSI Standard Light Source Screen

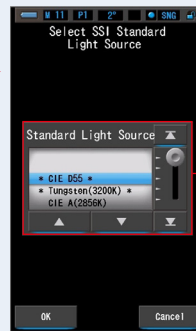

Standard Illuminant Display Area

2. Select the desired standard illuminant to compare.

To select the standard illuminant, match it with the blue background position.

Select SSI Standard Light Source Screen

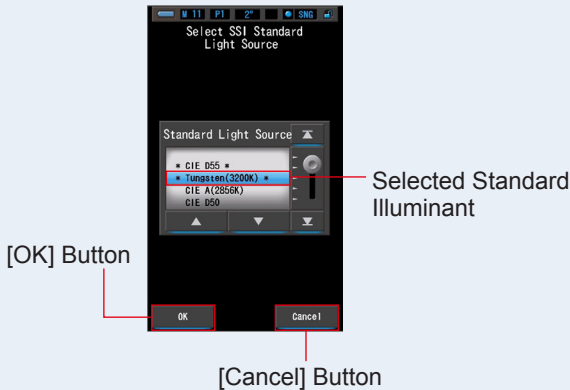

3. Touch the [OK] button.

Confirms the setting and returns to the SSI screen.

To cancel the setting, touch the [Cancel] button.

4. The selected standard illuminant will be displayed in the reference light source display area on the SSI screen.

You can select up to two reference light sources.

Reference Light Source Display Area

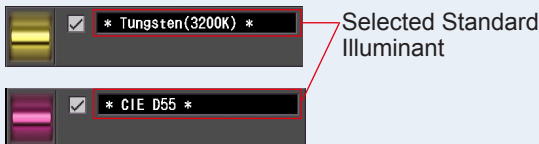

5. SSI value of current measurement to compare with the reference light source will be displayed.

Current Measurement Display Area



6. Yellow and Red line graphs will be displayed in the SSI spectrum graph.

Touch the [Graph Display ON/OFF] check box to hide/show a line graph on the screen.

* shows line. hides line.

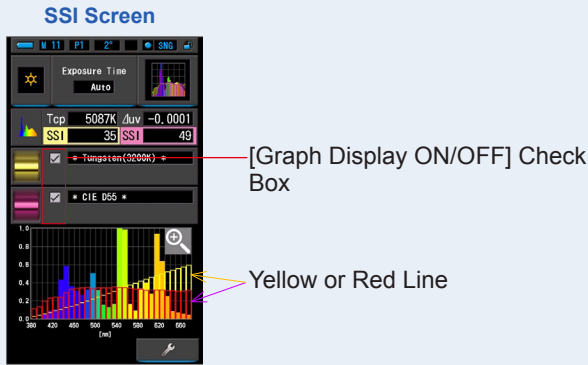

7. Touch the [Magnifying Glass (+)] icon.

The SSI spectrum graph will be enlarged.

The enlarged graph is displayed on the whole screen (landscape).

To return to the SSI screen, touch the [Magnifying Glass (-)] icon on the enlarged SSI spectrum graph.

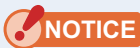
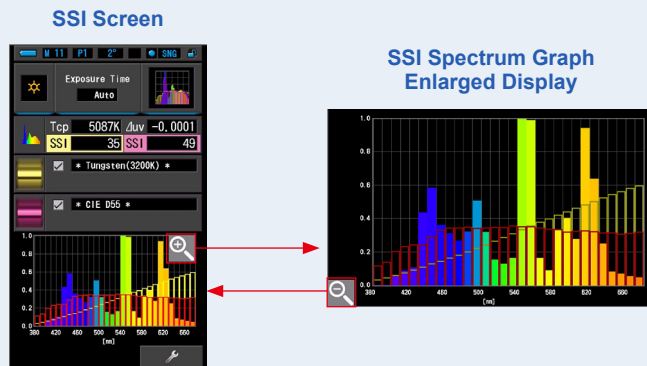

- When the enlarged graph is displayed, measurement cannot be performed.

8. Memorize the measurement results.

To record current measurements, press Memory Button . (→ P108)

[Color Temperature Input]

Input the color temperature in 100K step from 2500K to 7500K.

1. Touch the [Input Color Temperature] indication on the Select SSI Reference Light screen.

The Input SSI Color Temperature screen will be displayed.

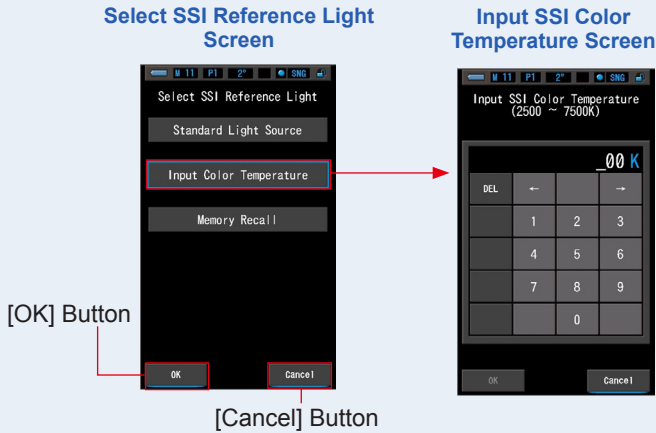

2. Input the desired color temperature to compare.

Input value is displayed in the color temperature display area.

Input SSI Color Temperature Screen

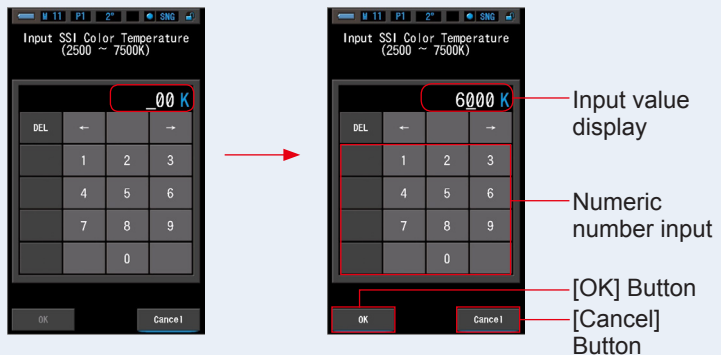

3. Touch the [OK] button.

Confirms the setting and returns to the SSI screen.

To cancel the setting, touch the [Cancel] button.

 **NOTE**

Depending on the input color temperature, calculation of light source is different.
 2,500K to 4,900K is the color temperature based on the black body radiation.
 5,000K to 7,500K is the color temperature based on daylight illuminant.

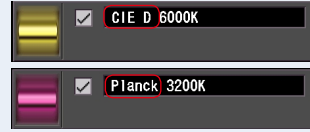
Display Example

4. The input color temperature will be displayed in the reference light source display area on the SSI screen.

You can select up to two reference light sources.

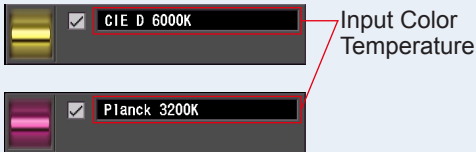
Reference Light Source Display Area

5. SSI value of current measurement to compare with the reference light source will be displayed.

Current Measurement Display Area

6. Yellow and Red line graphs will be displayed in the SSI spectrum graph.

Touch the [Graph Display ON/OFF] check box to hide/show a line graph on the screen.

* shows line. hides line.

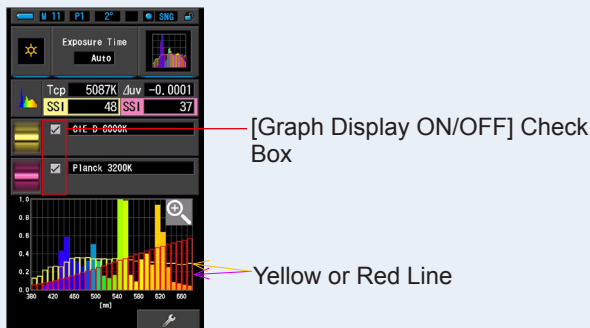
SSI Screen

7. Touch the [Magnifying Glass (+)] icon.

The SSI spectrum graph will be enlarged.

The enlarged graph is displayed on the whole screen (landscape).

To return to the SSI screen, touch the [Magnifying Glass (-)] icon on the enlarged SSI spectrum graph.

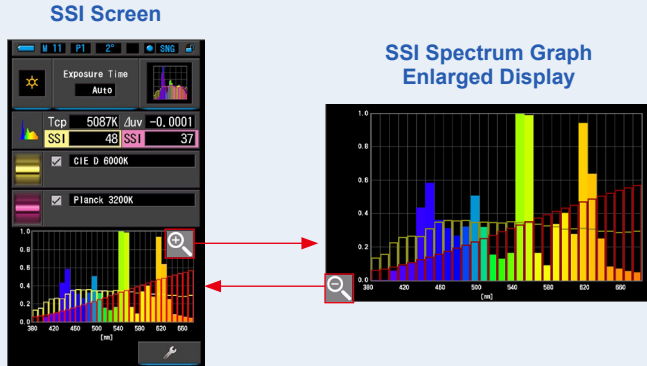

NOTICE

- When the enlarged graph is displayed, measurement cannot be performed.

8. Memorize the measurement results.

To record current measurements, press Memory Button  . (➔ P108)

[Memory Recall Selection]

You can select the reference light source from memory recall.

Memorize the measurements to be used as reference light source in advance, and compare the current measurement with memorized light source to see the difference in quality.

1. Touch the [Memory Recall] indication on the Select SSI Reference Light screen.

The SSI Memory Recall screen will be displayed.

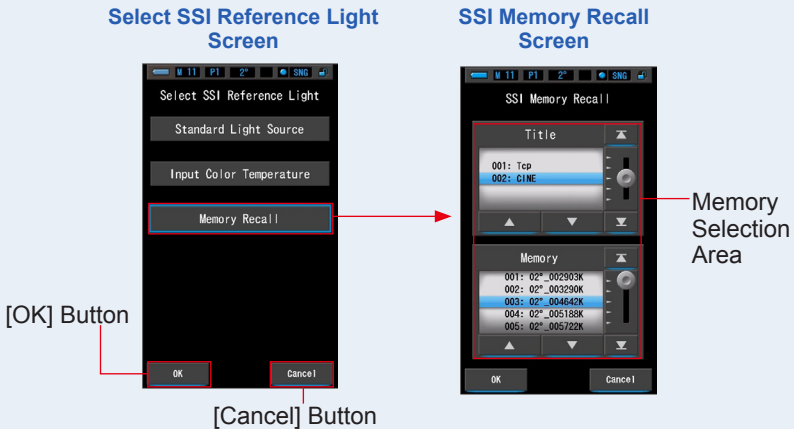

2. Select the desired memory data to compare.

When a title is selected, the memory linked to the title will be displayed.

Select a memorized reading for display and comparison.

To select a title and a memory, match them with the blue background positions.

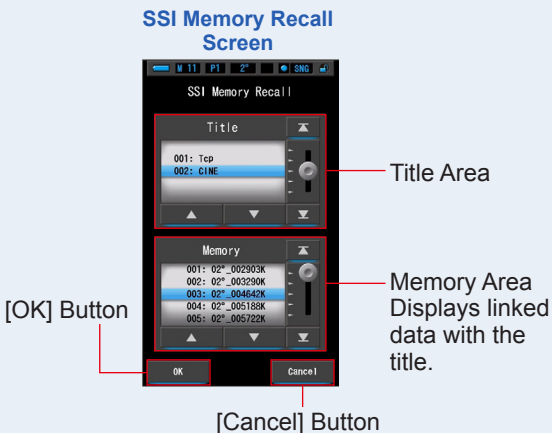

3. Touch the [OK] button.

Confirms the setting and returns to the SSI screen.

To cancel the setting, touch the [Cancel] button.

4. The selected memorized value will be displayed in the reference light source display area on SSI screen.

You can select up to two reference light sources.

Reference Light Source Display Area

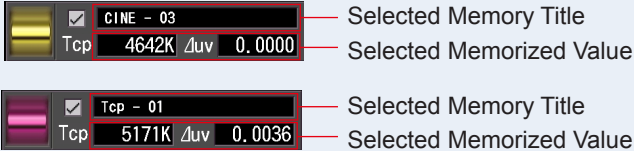

5. SSI value of current measurement to compare with the reference light source will be displayed.

Current Measurement Display Area



6. Yellow and Red line graphs will be displayed in the SSI spectrum graph.

Touch the [Graph Display ON/OFF] check box to hide/show a line graph on the screen.

* shows line. hides line.

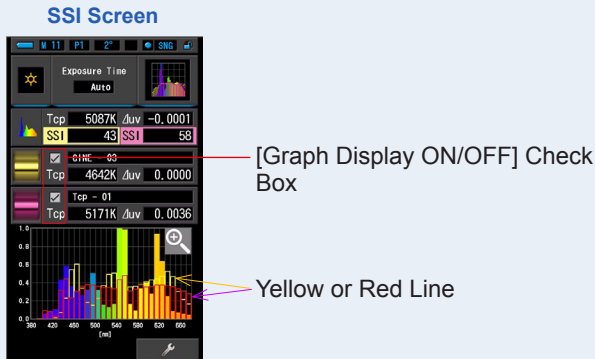

7. Touch the [Magnifying Glass (+)] icon.

The SSI spectrum graph will be enlarged.

The enlarged graph is displayed on the whole screen (landscape).

To return to the SSI screen, touch the [Magnifying Glass (-)] icon on the enlarged SSI spectrum graph.

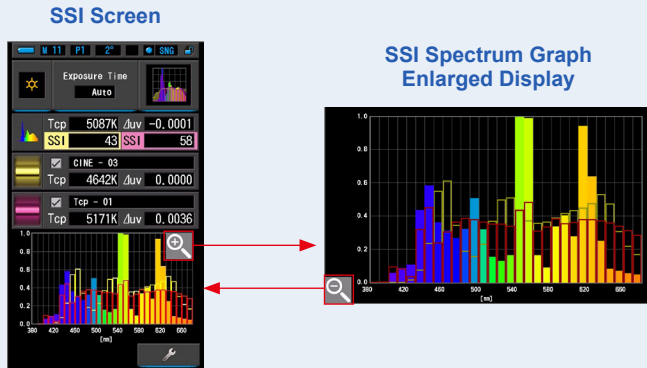

NOTICE

- When the enlarged graph is displayed, measurement cannot be performed.

8. Memorize the measurement results.

To record current measurements, press Memory Button **7** . (⇒ P108)

4-4-6 Displaying in TLCI or TLMF [TLCI/TLMF] Mode

Displays the current measurement values and memorized values (in color temperature and Δuv), TLCI and TLMF with spectrum graph.

TLCI stands for Television Lighting Consistency Index. TLMF stands for Television Luminaire Matching Factor. (➔ P205)

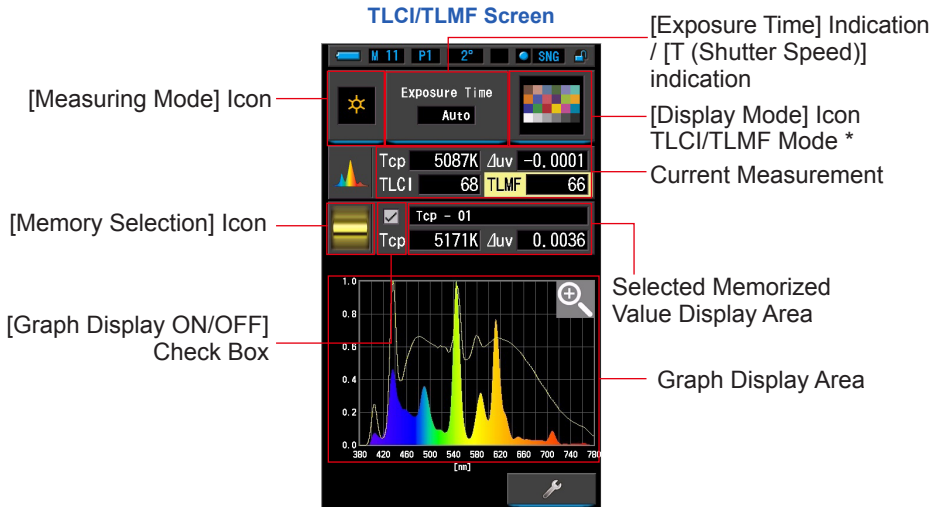

* X-Rite ColorChecker is used for TLCI/TLMF mode icon

Operation

1. Touch the [TLCI/TLMF] icon on the Display Mode Selection screen.

The TLCI/TLMF screen will be displayed. (➔ P30)

2. Touch the [Measuring Mode] icon.

The Measuring Mode Selection screen will be displayed. Select the desired measuring mode to use. (➔ P23)



3. Touch the [Exposure Time] indication or [T (Shutter Speed)] indication on the Measuring screen.

For ambient light measurement, select the [Auto], [0.1 sec] or [1.0 sec] button. (➔ P25)

For flash light measurement, select the desired shutter speed. (➔ P26)

4. Press the Measuring Button ⑤ to measure.

The Light Selection Ring ② should be set to L () when taking ambient light measurements.

When measuring flash units, select Range L () or Range H () depending on the brightness of the flash. (➔ P102, ➔ P103)

Measurements are now displayed.

Light Selection Ring ②

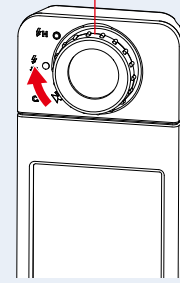

Measuring Button ⑤



- Measurements and display will take longer in light levels below 30lx. The LCD illumination will normally switch off during measurements to avoid influence to measurements.

5. Current measurement appears with the spectrum graph.

6. Touch the [Memory Selection] icon.

The [TLMF Memory Recall] screen will be displayed.

TLCI/TLMF Screen

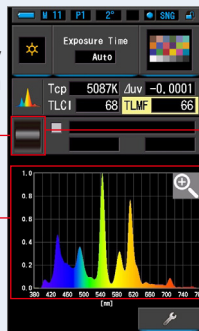

[Memory Selection] Icon

Current measurement in graph

TLMF Memory Recall Screen

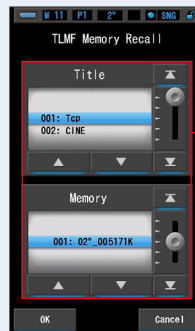

Memory Selection Area

If no measurements have been memorized, the pop-up screen appears to indicate no memorized value.

Memory Selection Pop-up Screen

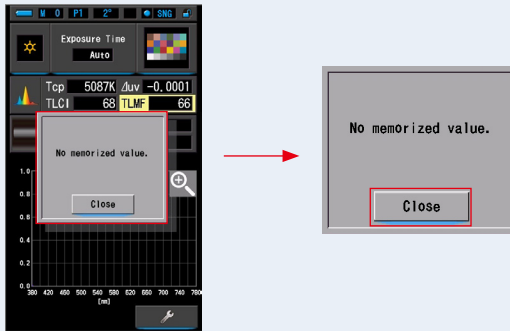

After you confirmed the message "No memorized value.", touch the [Close] button. Returns to the TLCI/TLMF screen.

After memorizing several values, select the memorized value again.

7. Select the desired memorized value to compare.

When a title is selected, the memory linked to the title will be displayed.

Select a memorized reading for display and comparison.

To select a title and a memory, match them with the blue background positions.

Spectrum Comp. Memory Recall Screen

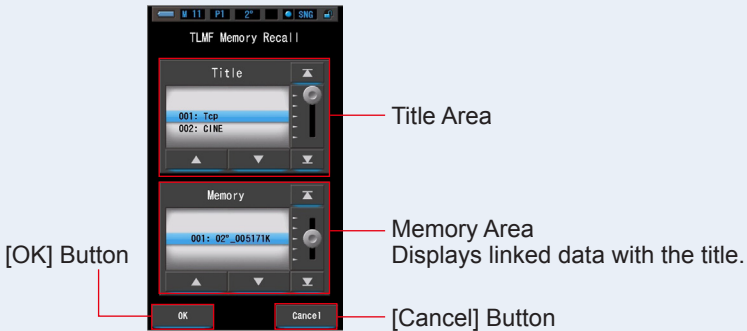

8. Touch the [OK] button.

Confirms the setting and returns to the TLCI/TLMF screen.

To cancel the setting, touch the [Cancel] button.

9. The title of selected memory will be displayed on the TLCI/TLMF screen.

Memory Title Display



10. TLMF index is displayed to compare with the selected memorized value.

Current Measurement Display Area



11. Line graphs will be displayed in the TLCI/TLMF graph.

Touch the [Graph Display ON/OFF] check box to hide/show a line graph on the screen.

* shows line. hides line.

TLCI/TLMF Screen

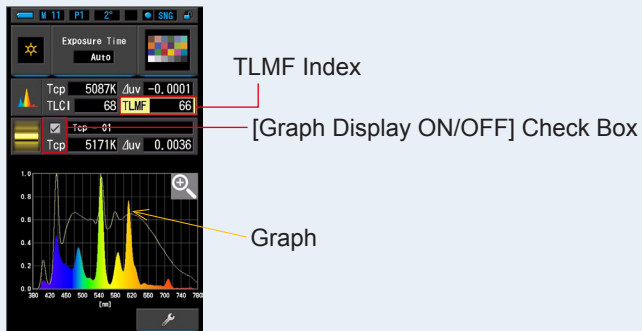

12. Touch the [Magnifying Glass (+)] icon.

The spectrum comparison graph will be enlarged.

The enlarged graph is displayed on the whole screen (landscape).

To return to the TLCI/TLMF screen, touch the [Magnifying Glass (-)] icon on the enlarged spectrum comparison graph.

TLCI/TLMF Screen

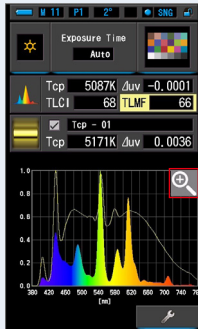

TLCI/TLMF Graph Enlarged Display

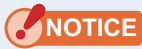
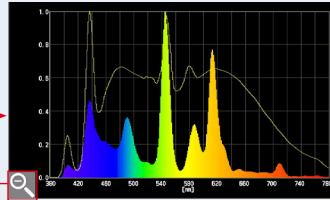

- When the enlarged graph is displayed, measurement cannot be performed.

13. Memorize the measurement results.

To record current measurements, press Memory Button  . (➔ P108)

4-4-7 Displaying in CIE1931 (CIE1964) [CIE1931 (CIE1964)] Mode

Displays the measurement result in text format together with the position on the CIE1931 (or CIE1964) chromaticity diagram.

When 2 degrees of view of angle is selected in Hardware Setting, this mode shows CIE1931.

CIE1964 appears when 10 degrees of view of angle is selected.

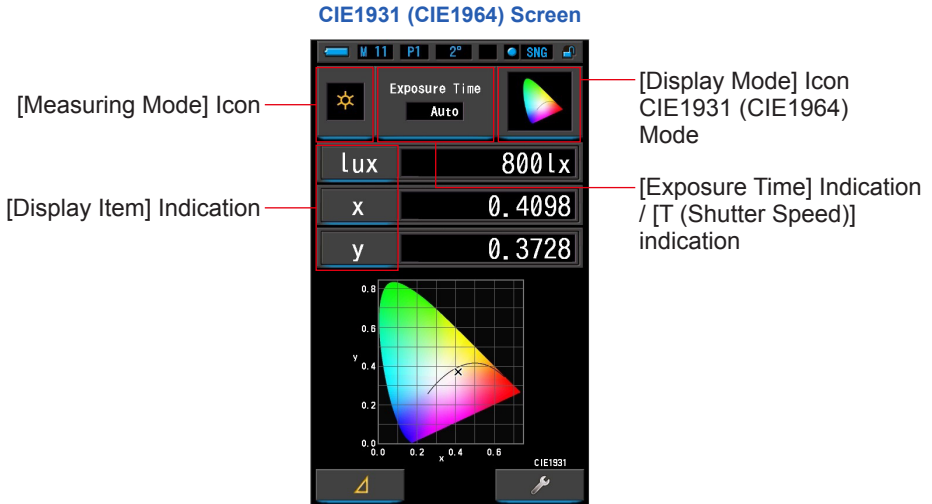

Operation

1. Touch the [CIE1931 (CIE1964)] icon on the Display Mode Selection screen.

The CIE1931 (CIE1964) screen will be displayed. (➔ P30)

2. Touch the [Measuring Mode] icon.

The Measuring Mode Selection screen will be displayed. Select the desired measuring mode to use. (➔ P23)



3. Touch the [Exposure Time] indication or [T (Shutter Speed)] indication on the Measuring screen.

For ambient light measurement, select the [Auto], [0.1 sec] or [1.0 sec] button. (➔ P25)

For flash light measurement, select the desired shutter speed. (➔ P26)

4. Press the Measuring Button 5 to measure.

The Light Selection Ring 2 should be set to L () when taking ambient light measurements.

When measuring flash units, select Range L () or Range H () depending on the brightness of the flash. (➔ P102, ➔ P103)

Measurements are now displayed.

Light Selection Ring 2

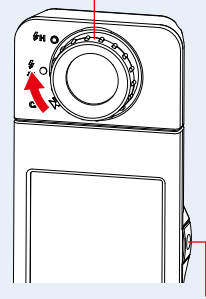

Measuring Button 5

5. The measured value is indicated by a black "x".

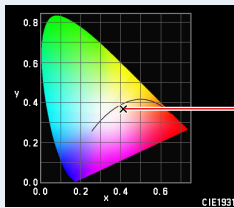

Measured value



NOTE

- Measurement and display will take longer in light levels below 30lx.
The LCD illumination will normally switch off during measurement to avoid influence to measurement.

6. Memorize the measurement results.

To record measurements, press Memory Button 7 . (➔ P108)

4-4-8 Displaying in CIE1976 [CIE1976] Mode

Displays the measurement result in text format together with position on the CIE1976 chromaticity diagram.

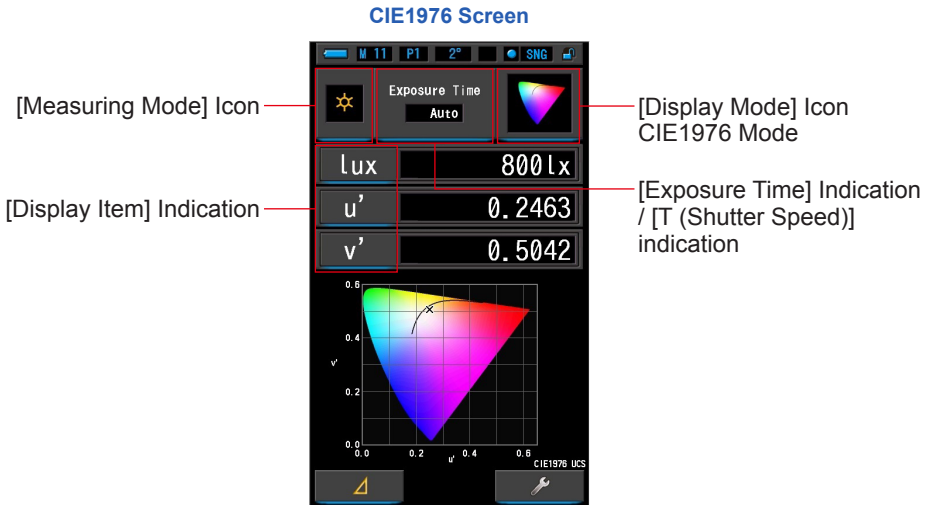

Operation

1. Touch the [CIE1976] icon on the Display Mode Selection screen.

The CIE1976 screen will be displayed. (➔ P30)

2. Touch the [Measuring Mode] icon.

The Measuring Mode Selection screen will be displayed. Select the desired measuring mode to use. (➔ P23)

3. Touch the [Exposure Time] indication or [T (Shutter Speed)] indication on the Measuring screen.

For ambient light measurement, select the [Auto], [0.1 sec] or [1.0 sec] button. (➔ P25)

For flash light measurement, select the desired shutter speed. (➔ P26)

4. Press the Measuring Button 5 to measure.

The Light Selection Ring 2 should be set to L (⚡ (●)) when taking ambient light measurements.

When measuring flash units, select Range L (⚡ (●)) or Range H (⚡⚡ (●)) depending on the brightness of the flash. (➔ P102, ➔ P103)

Measurements are now displayed.

Light Selection Ring 2

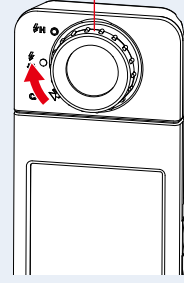

Measuring Button 5

5. The measured value is indicated by a black "x".

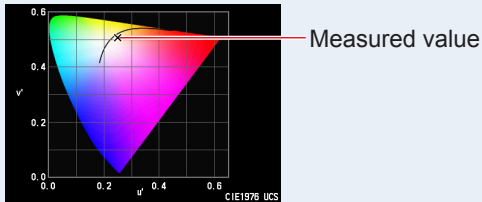

NOTE

- Measurement and display will take longer in light levels below 30lx. The LCD illumination will normally switch off during measurement to avoid influence to measurement.

6. Memorize the measurement results.

To record current measurements, press Memory Button 7. (➔ P108)

4-4-9

Displaying in Spectrum Comparison [Spectrum Comp.] Mode

Compares the current measurement value and up to 2 memorized values as yellow and/or red lines in the spectrum distribution graph.

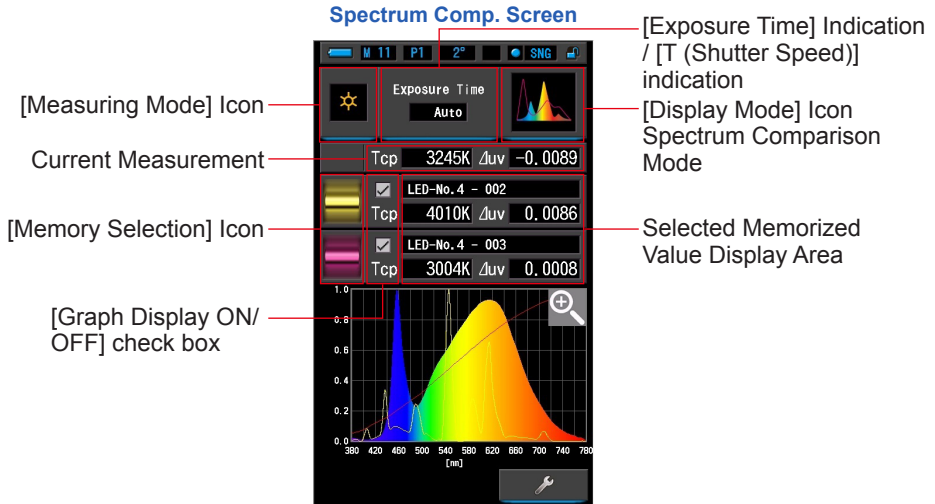

Operation

1. Touch the [Spectrum Comp.] icon on the Display Mode Selection screen.

The Spectrum Comp. screen will be displayed. (➔ P30)

2. Touch the [Measuring Mode] icon.

The Measuring Mode Selection screen will be displayed. Select the desired measuring mode to use. (➔ P23)



3. Touch the [Exposure Time] indication or [T (Shutter Speed)] indication on the Measuring screen.

For ambient light measurement, select the [Auto], [0.1 sec] or [1.0 sec] button. (➔ P25)

For flash light measurement, select the desired shutter speed. (➔ P26)

4. Press the Measuring Button ⑤ to measure.

The Light Selection Ring ② should be set to L () when taking ambient light measurements.

When measuring flash units, select Range L () or Range H () depending on the brightness of the flash. (→ P102, → P103)

Measurements are now displayed.

Light Selection Ring ②

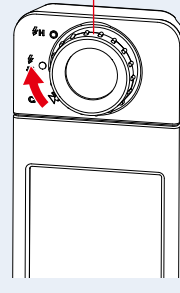

Measuring Button ⑤



NOTE

- Measurement and display will take longer in light levels below 30lx.
The LCD illumination will normally switch off during measurement to avoid influence to measurement.

5. The current measurement is displayed at the top of display area with rainbow colored spectrum graph.

6. Touch the [Memory Selection] icon.

The [Spectrum Comp. Memory Recall] screen will be displayed.

Spectrum Comp.
Screen

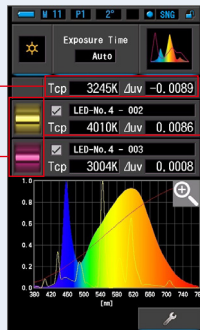

Current Measurement

[Memory Selection] Icon

Spectrum Comp. Memory
Recall Screen

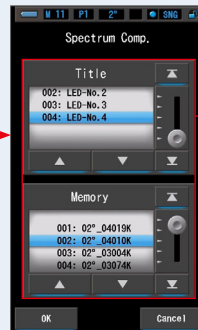

Memory Selection Area

If no measurements have been memorized, the pop-up screen appears to indicate no memorized value.

Memory Selection Pop-up Screen



After you confirmed the message "No memorized value.", touch the [Close] button. Returns to the Spectrum Comp. screen.

After memorizing several values, select the memorized value again.

7. Select the desired memory data to compare the spectrum.

When a title is selected, the memory linked to the title will be displayed.

Select a memorized reading for display and comparison.

To select a title and a memory, match them with the blue background positions.

Spectrum Comp. Memory Recall Screen

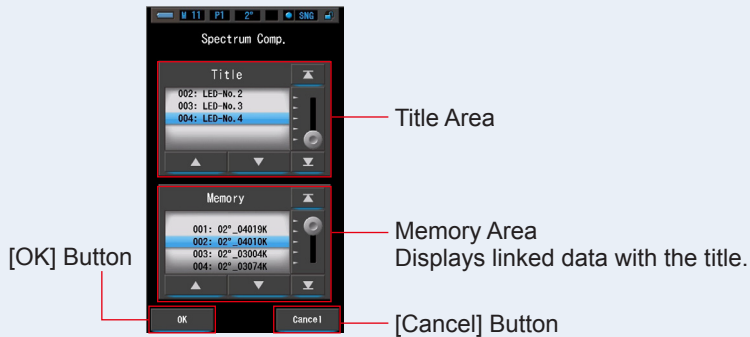

8. Touch the [OK] button.

Confirms the setting and returns to the Spectrum Comp. screen.

To cancel the setting, touch the [Cancel] button.

9. The titles and measurements of the selected memories will be displayed on the Spectrum Comp. screen.

Memory Title Display

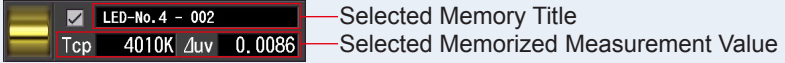

10. Line graphs will be displayed in the spectrum graph.

Touch the [Line Graph Display ON/OFF] check box to hide/show a line graph on the screen.

* shows line. hides line.

Spectrum Comp. Screen

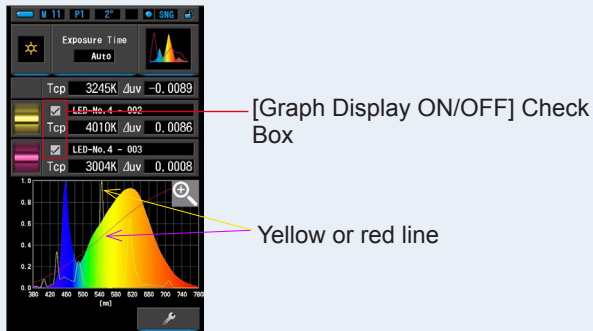

11. Touch the [Magnifying Glass (+)] icon.

The spectrum comparison graph will be enlarged.

The enlarged graph is displayed on the whole screen (landscape).

To return to the Spectrum Comp. screen, touch the [Magnifying Glass (-)] icon on the enlarged spectrum comparison graph.

Spectrum Comp. Screen

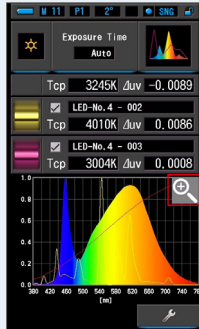

Spectrum Comparison Graph Enlarged Display

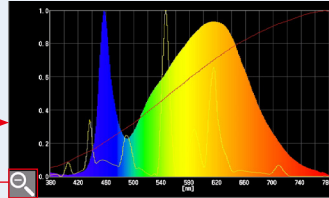

NOTICE

- When the enlarged graph is displayed, measurement cannot be performed.

NOTE

- The maximum display value of the Y-axis can be selected in the [Spectrum Y Axis Scale] in "Customize" on page 1 of Setting screen. (➔ P140)
- During Spectrum Comparison Mode, the Contrast Function is not available and [] button will be hidden.

12. Memorize the measurement results.

To record measurements, press Memory Button  . (➔ P108)

4-4-10

Displaying in Color Rendering Index Comparison [CRI Comp.] Mode

Compares the current measurement value and memorized value to show the color temperature and average CRI (Ra). Also individual CRI (R1 to R15) is displayed in each graph.

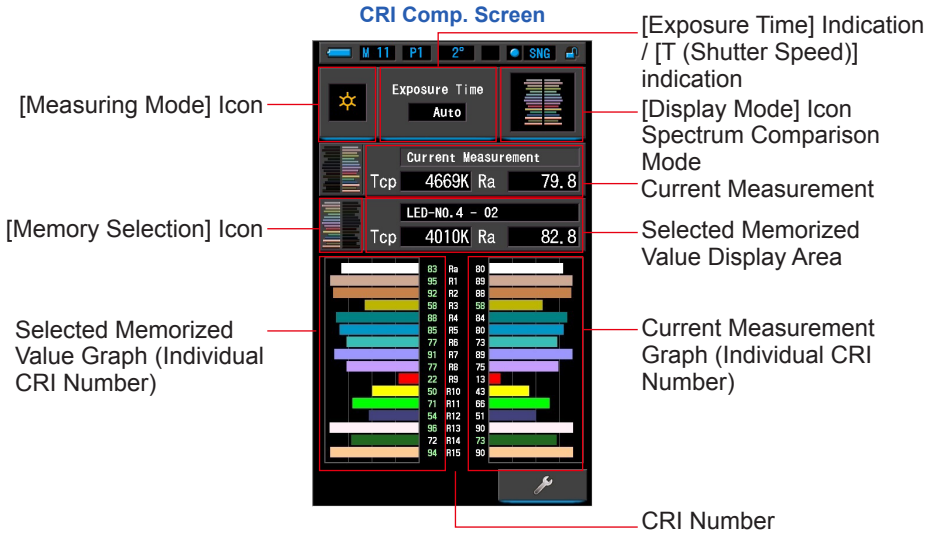

Operation

1. Touch the [CRI Comp.] icon on the Display Mode Selection screen.

The CRI Comp. screen will be displayed. (➔ P30)

2. Touch the [Measuring Mode] icon.

The Measuring Mode Selection screen will be displayed. Select the desired measuring mode to use. (➔ P23)



3. Touch the [Exposure Time] indication or [T (Shutter Speed)] indication on the Measuring screen.

For ambient light measurement, select the [Auto], [0.1 sec] or [1.0 sec] button. (➔ P25)

For flash light measurement, select the desired shutter speed. (➔ P26)

4. Press the Measuring Button ⑤ to measure.

The Light Selection Ring ② should be set to L () when taking ambient light measurements.

When measuring flash units, select Range L () or Range H () depending on the brightness of the flash. (→ P102, → P103)

Measurements are now displayed.

Light Selection Ring ②

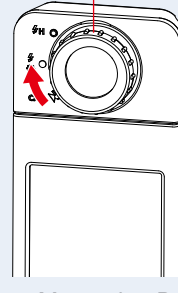

Measuring Button ⑤



NOTE

- Graph display areas Ra, R1 to R15 are always displayed.
- Measurements and display will take longer in light levels below 30lx. The LCD illumination will normally switch off during measurements to avoid influence to measurements.
- Ra is the averaged value from R1 to R8 only. R9 to R15 are not included in the Ra.

5. Current measurement appears with the graph in the right side of display.

6. Touch the [Memory Selection] icon.

The [CRI Comp. Memory Recall] screen will be displayed.

CRI Comp. Screen

CRI Comp. Memory Recall Screen

[Memory Selection] Icon

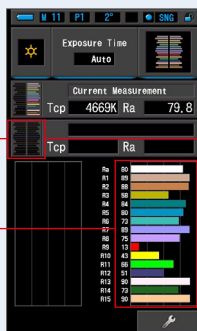

Current Measurement Graph
(Individual CRI Number)

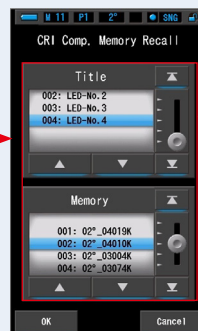

Memory Selection Area

If no measurements have been memorized, the pop-up screen appears to indicate no memorized value.

Memory Selection Pop-up Screen

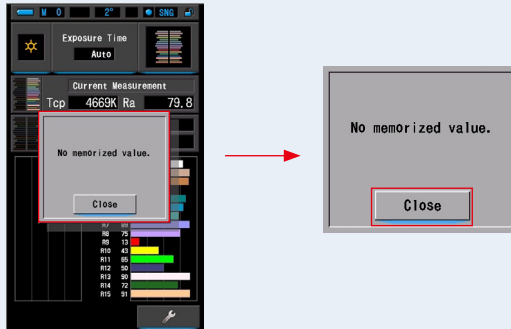

After you confirmed the message "No memorized value.", touch the [Close] button. Returns to the CRI Comp. screen.

After memorizing several values, select the memorized value again.

7. Select the desired memory data to compare the CRI.

When a title is selected, the memory linked to the title will be displayed.

Select a memorized reading for display and comparison.

To select a title and a memory, match them with the blue background positions.

CRI Comp. Memory Recall Screen

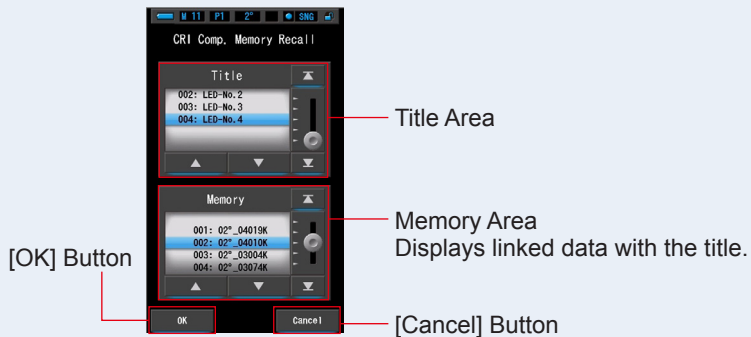

8. Touch the [OK] button.

Confirms the setting and returns to the CRI Comp. screen.

To cancel the setting, touch the [Cancel] button.

9. The titles and measurements of the selected memories will be displayed on the CRI Comp. screen.

Memory Title Display

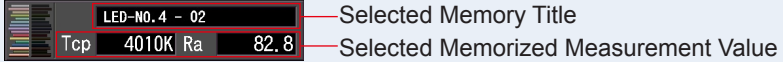

Selected Memory Title

Selected Memorized Measurement Value

10. Selected memorized value and graph are displayed on the CRI Comp. screen

Current measurement appears on the right side of graph, and selected memorized value appears on the left side of graph.

CRI Comp. Screen

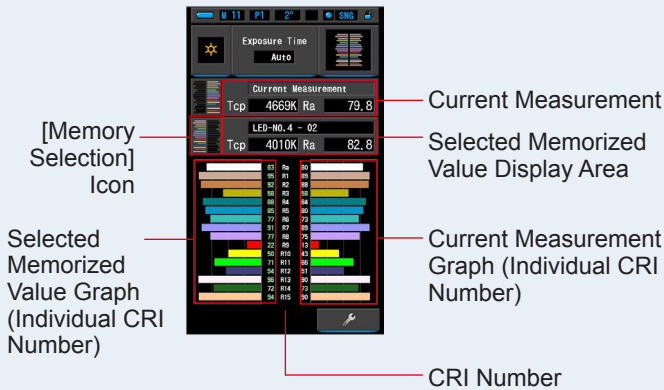

Current Measurement

Selected Memorized Value Display Area

Current Measurement Graph (Individual CRI Number)

CRI Number

[Memory Selection] Icon

Selected Memorized Value Graph (Individual CRI Number)

11. Memorize the measurement results.

To record measurements, press Memory Button  . (→ P108)

4-4-11

Displaying in CIE1931 (CIE1964) Comparison [CIE1931 (CIE1964) Comp.] Mode

Displays the measured result in text format together with the position on the CIE1931 (or CIE1964) chromaticity diagram. The measured result can be compared with up to 2 sets of memorized values.

When 2 degrees of view of angle is selected in Hardware Setting, this mode shows CIE1931.

CIE1964 appears when 10 degrees of view of angle is selected.

CIE1931 (CIE1964) Comp. Screen

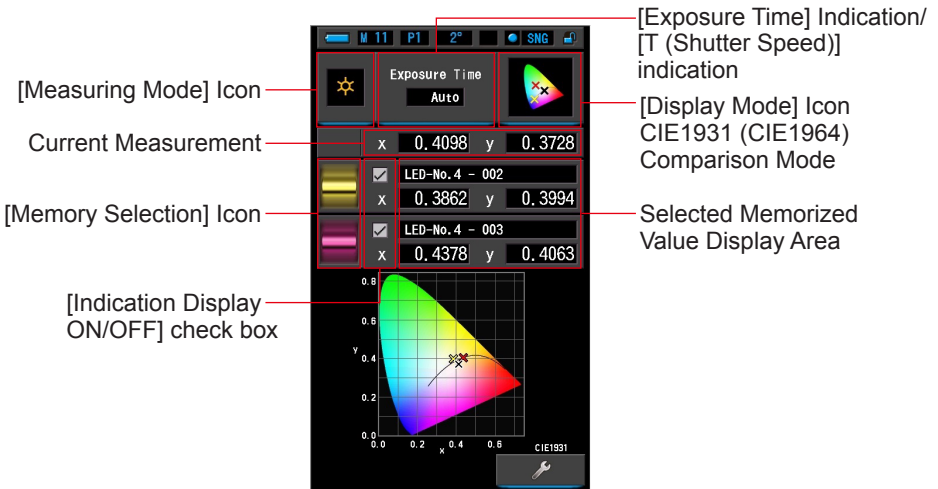

Operation

1. Touch the [CIE1931 (CIE1964) Comp.] icon on the Display Mode Selection screen.

The CIE1931 (CIE1964) Comp. screen will be displayed. (➔ P30)

2. Touch the [Measuring Mode] icon.

The Measuring Mode Selection screen will be displayed. Select the desired measuring mode to use. (➔ P23)



3. Touch the [Exposure Time] indication or [T (Shutter Speed)] indication on the Measuring screen.

For ambient light measurement, select the [Auto], [0.1 sec] or [1.0 sec] button. (➔ P25)

For flash light measurement, select the desired shutter speed. (➔ P26)

4. Press the Measuring Button 5 to measure.

The Light Selection Ring 2 should be set to L  when taking ambient light measurements.

When measuring flash units, select Range L  or Range H  depending on the brightness of the flash. (→ P102, → P103)

Measurements are now displayed.

Light Selection Ring 2

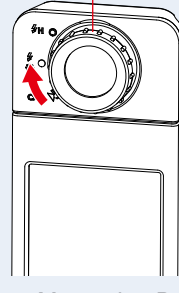

Measuring Button 5



NOTE

- Measurement and display will take longer in light levels below 30lx.
The LCD illumination will normally switch off during measurement to avoid influence to measurement.

5. The current measurement value is indicated by a black "x".

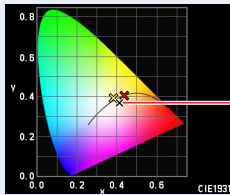

Measured value

6. Touch the [Memory Selection] icon.

The [CIE1931 (CIE1964) Comp.] screen will be displayed.

CIE1931 (CIE1964) Comp. Screen

CIE1931 (CIE1964) Comp. Memory Screen

Current Measurement

[Memory Selection] Icon

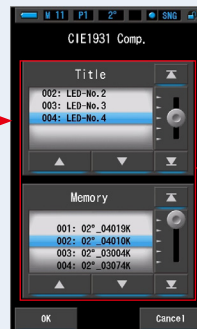
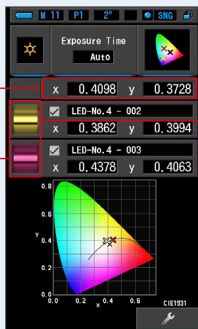

Memory Selection Area

If no measurements have been memorized, the pop-up screen appears to indicate no memorized value.

Memory Selection Pop-up Screen

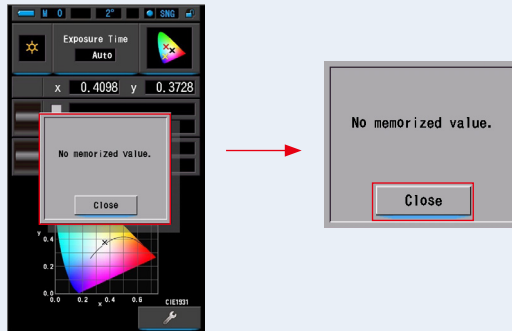

After you confirmed the message "No memorized value.", touch the [Close] button.

Returns to the CIE1931 (1964) Comp. screen.

After memorizing several values, select the memorized value again.

7. Select the desired memory data to compare the CIE1931 (CIE1964).

When a title is selected, the memory linked to the title will be displayed.

Select a memorized reading for display and comparison.

To select a title and a memory, match them with the blue background positions.

CIE1931 (CIE1964) Comparison Title/Memory Screen

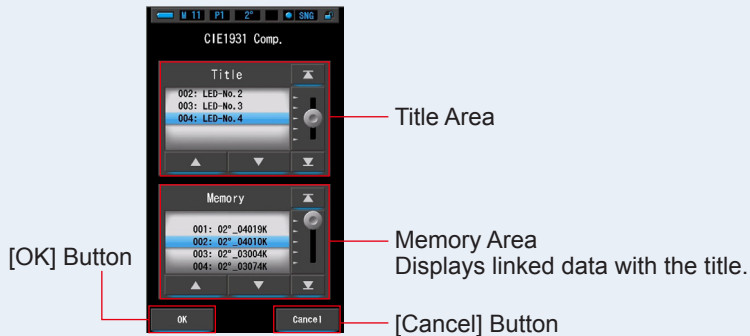

8. Touch the [OK] button.

Confirms the setting and returns to the CIE1931 (CIE1964) Comp. screen.

To cancel the setting, touch the [Cancel] button.

9. The titles and measurements of the selected memory data will be displayed on the CIE1931 (1964) Comp. screen.

Memory Title Display



— Selected Memory Title

— Selected Memorized Measurement Value

10. X mark in yellow or red will be displayed on the CIE1931 (CIE1964) chromaticity diagram.

Touch the [Indication Display ON/OFF] to hide/show a x mark on the screen.

* shows x mark. hides x mark.

CIE1931 (CIE1964) Comp. Screen

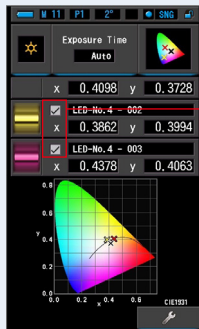

[Indication Display ON/OFF]
Check Box

11. Memorize the measurement results.

To record current measurements, press Memory Button **7** . (→ P108)



NOTE

- During CIE1931 (or CIE1964) comparison, the Comparison Function is not available and  button will be hidden even if a Preset with this function is selected.

4-4-12

Displaying in CIE1976 Comparison [CIE1976 Comp.] Mode

Displays the measurement result in text format together with the position on the CIE1976 chromaticity diagram. The measured result can be compared with up to 2 sets of Memorized Value.

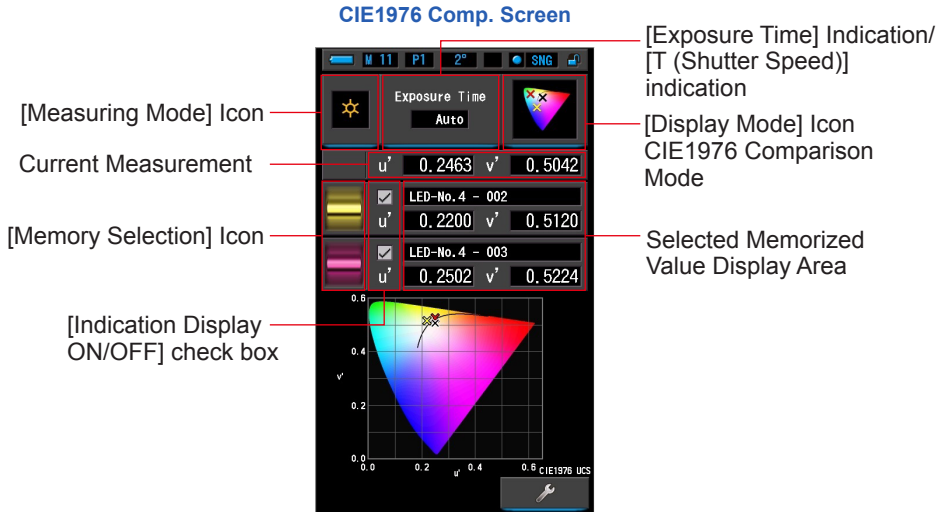

Operation

1. Touch the [CIE1976 Comp.] icon on the Display Mode Selection screen.

The CIE1976 Comp. screen will be displayed. (➔ P30)

2. Touch the [Measuring Mode] icon.

The Measuring Mode Selection screen will be displayed. Select the desired measuring mode to use. (➔ P23)



3. Touch the [Exposure Time] indication or [T (Shutter Speed)] indication on the Measuring screen.

For ambient light measurement, select the [Auto], [0.1 sec] or [1.0 sec] button. (➔ P25)

For flash light measurement, select the desired shutter speed. (➔ P26)

4. Press the Measuring Button 5 to measure.

The Light Selection Ring 2 should be set to L  when taking ambient light measurements.

When measuring flash units, select Range L  or Range H  depending on the brightness of the flash. (→ P102, → P103)

Measurements are now displayed.

Light Selection Ring 2

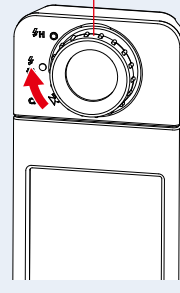

Measuring Button 5



NOTE

- Measurement and display will take longer in light levels below 30lx.
The LCD illumination will normally switch off during measurement to avoid influence to measurement.

5. The current measurement value is indicated by a black "x".

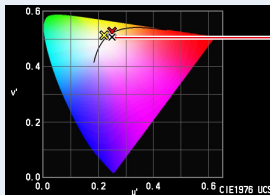

Measured value

6. Touch the [Memory Selection] icon.

The [CIE1976 Comp. Memory Recall] screen will be displayed.

CIE1976 Comp. Screen

CIE1976 Comp. Memory Recall Screen

[Memory Selection] Icon

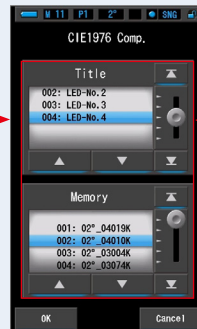
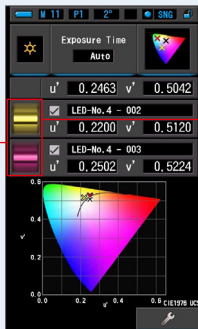

Memory Selection Area

If no measurements have been memorized, the pop-up screen appears to indicate no memorized value.

Memory Selection Pop-up Screen

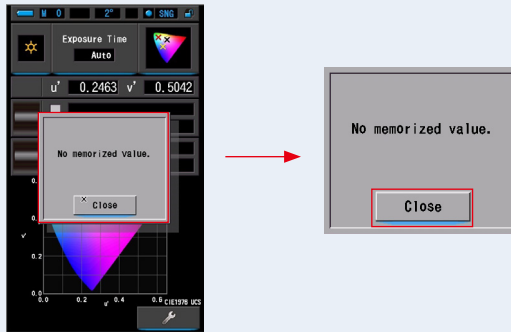

After you confirmed the message "No memorized value.", touch the [Close] button. Returns to the CIE1976 Comp. screen.

After memorizing several values, select the memorized value again.

7. Select the desired memorized value to compare the CIE1976 Comp..

When a title is selected, the memory linked to the title will be displayed. Select a memorized reading for display and comparison.

To select a title and a memory, match them with the blue background positions.

CIE1976 Comp. Memory Recall Screen

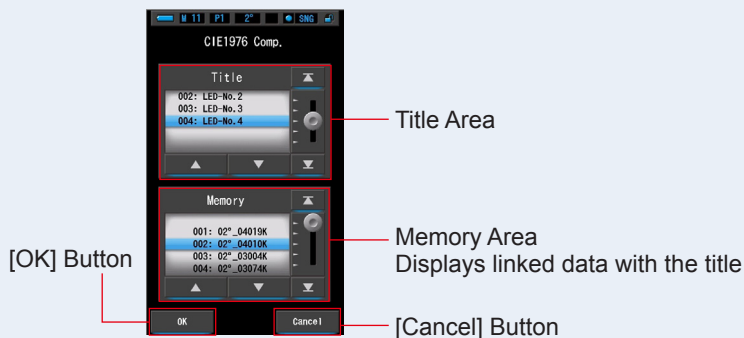

8. Touch the [OK] button.

Confirms the setting and returns to the CIE1976 Comp. screen.

To cancel the setting, touch the [Cancel] button.

9. The titles and measurements of the selected memories will be displayed on the CIE1976 Comp. screen.

Memory Title Display

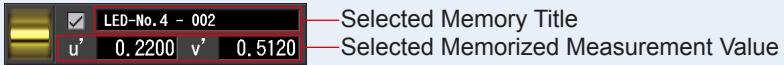

10. X mark in yellow or red will be displayed on the CIE1931 (CIE1964) chromaticity diagram.

Touch the [Indication Display ON/OFF] to hide/show a x mark on the screen.

* shows x mark. hides x mark.

CIE1976 Comp. Screen

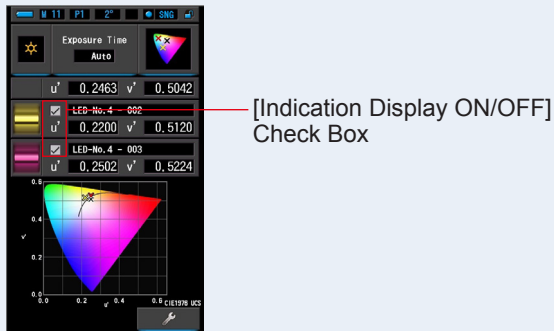

11. Memorize the measurement results.

To record current measurements, press Memory Button  . (→ P108)

NOTE

- During CIE1976 comparison, the Comparison Function is not available and  button will be hidden even if a Preset with this function is selected.

4-4-13 Displaying Setting [Setting] Screen

Displays the settings. The contents can be changed according to usage.

For more information about how to set and the details of specifications, see "7-1-1 Item List". (➔ P135)

Setting Screen
Page 1

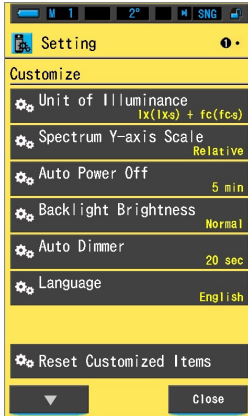

Setting Screen
Page 2



* Models sold in some countries do not display illuminance and exposure in "fc (fc-s)" due to legal restrictions. In this case, "Unit of Illuminance" is not displayed.



- Pressing the Menu Button **6** will exit the settings and return to the Display Mode Selection screen.

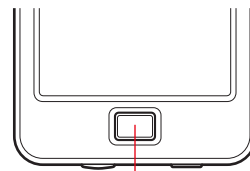

Menu Button **6**

Operation

1. Touch the [Setting] icon on page 2 of Display Mode Selection screen.

The Setting screen will be displayed.

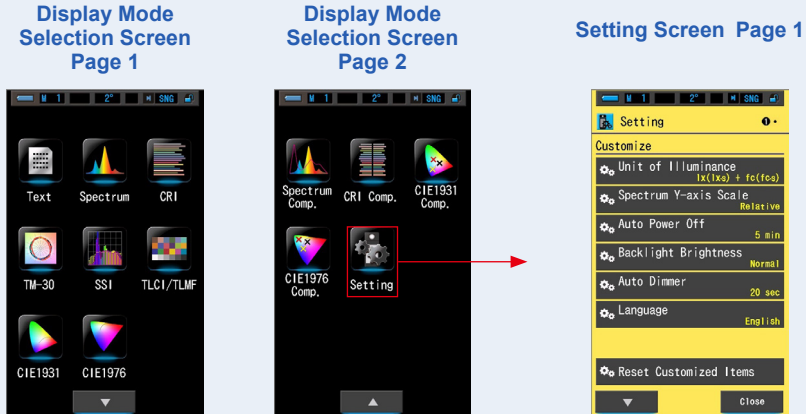

2. Settings show items in white letters and set values in yellow letters.

Touch each item to change the setting.

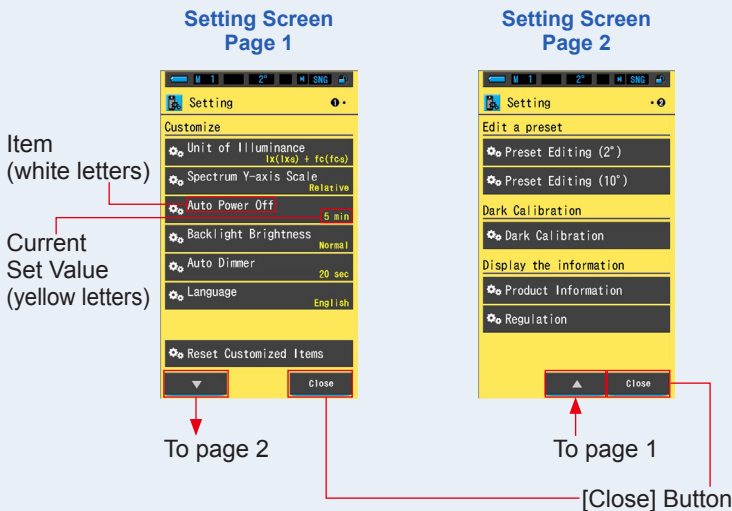

When the [Close] button is touched, the display returns to the Display Mode Selection screen. For more information about how to set and the details of specifications, see "Item List". (▶ P135)

5. Measuring Light Sources [Measurement Screen]

5-1 Measurement Method

Take a measurement by facing the Light Receptor ① towards the light source to correctly measure the color temperature of the light source.

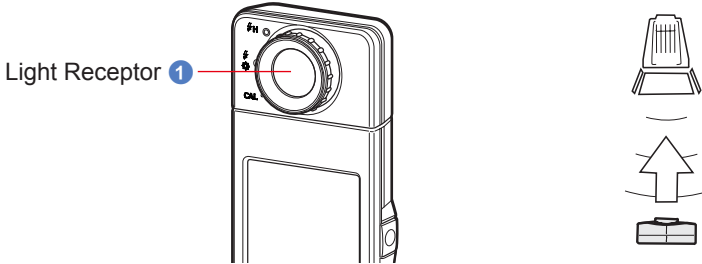

NOTICE

- When taking measurements, the C-7000 should be located at a distance that is approximately 10 times (10X) the diameter of the light source being measured.
- To get accurate color from a light source, make sure not to get bounced or reflected light from a colored surface, or another light.
- Damage and dirt on the Light Receptor ① can affect the precision of the measurement. If the Light Receptor ① becomes dirty, wipe it with a dry, soft cloth. Never use organic solvents such as thinner or benzene.
- Be courteous to those around you that may be sensitive to flash, or bright light, please give them notice before taking a measurement.

5-2

Measurement in Ambient Light Mode

Select Ambient Light Mode when taking measurements of natural light (sunlight), and continuous light sources such as LED, tungsten lamps and fluorescent lights.

WARNING

Do not look directly into sunlight or other strong light when measuring. It may cause severe eye damage or even loss of vision.

Operation

1. On the Measuring screen, touch the [Measuring Mode] icon and select the [Ambient Mode] icon on the Measuring Mode Selection screen. (→ P23)

Select the measuring mode.

Measuring Screen



Measuring Mode Selection Screen

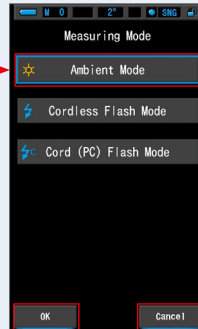

[OK] Button [Cancel] Button

2. Touch the [OK] button.

Confirms and returns to the Measuring screen.

To return to the Measuring screen without confirming, touch the [Cancel] button.

3. Touch the [Exposure Time] indication on the Measuring screen.

Exposure Time Screen appears. (→ P25)

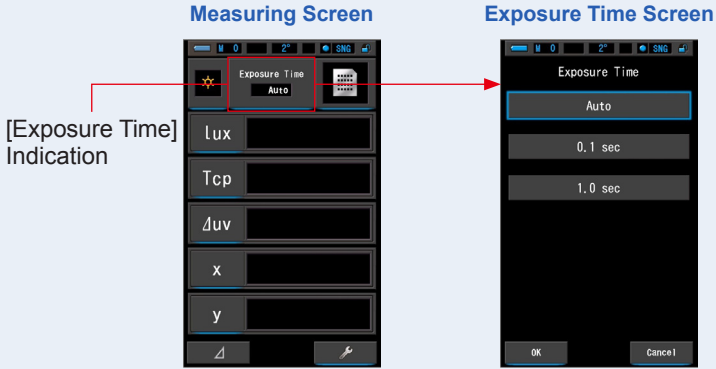

4. Select the exposure time.

Touch the [Auto], [0.1 sec] or [1.0 sec] button.

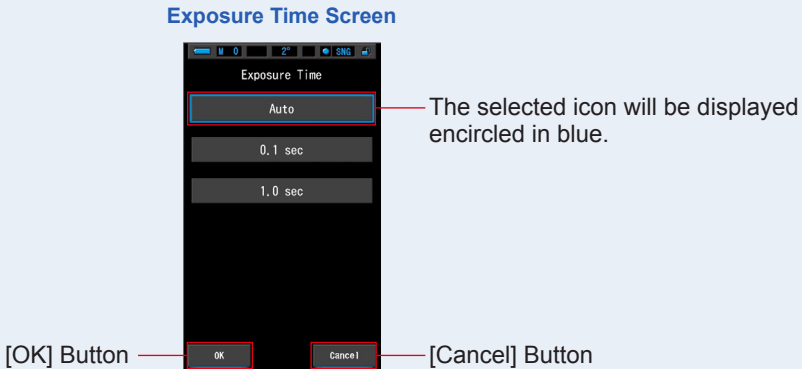

5. Touch the [OK] button.

Confirms and returns to the Measuring screen.

To return to the Measuring screen without confirming, touch the [Cancel] button.

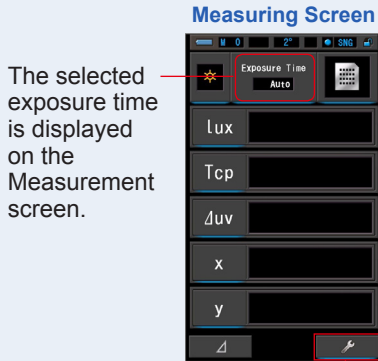

The selected exposure time is displayed on the Measurement screen.

Tool Box Screen

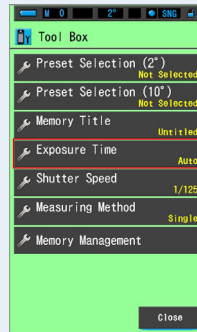

[Tool Box] Button



NOTE

- Exposure Time can also be set in the Tool Box. (→ P126)

6. Confirm the light measuring range.

When you return to the Measurement screen, make sure to select Range L ().

7. Press the Measuring Button 5.

Measurements are now displayed.

While the button is held, the meter measures continuously.

When the button is released, the measurements will stop and the light source value at the time of release will be displayed.

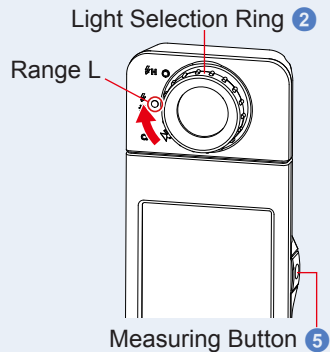

NOTE

- The default measuring method is single measurement. You can select continuous measurement in Tool Box. (→ P130)
- [Over] or [Under] will be displayed if the light source illumination is too bright or not bright enough, or if the color temperature is out of the measurement range, when the Measuring Button is pressed. (→ P102)
In this case, adjust the brightness or color temperature of light source.
- Measurement and display will take longer in light levels below 30lx. The LCD illumination will normally switch off during measurement to avoid influence to measurement.

Measurement in Ambient Light Mode is complete.

 **NOTE**

- You can select a previously created Preset value from Preset Selection in the Tool Box. (→ P152)

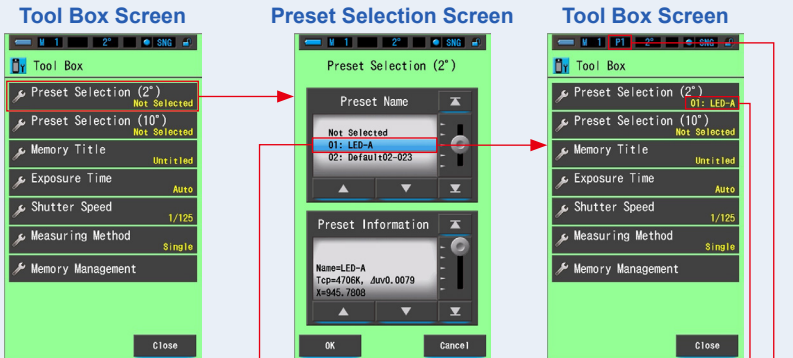

Tool Box Screen **Preset Selection Screen** **Tool Box Screen**

Blue bar indicates the item selected.

The set content is displayed
The selected Preset No. is displayed

If no presets have been created, the Preset Selection will be grayed out and touching the button will not display the Preset Selection Display.

 **NOTICE**

- A Preset value must be created and saved in the Preset Editing under the "Setting Mode" icon before use.
Preset Selection buttons will be grayed out until settings are created.

5-3 Measurement in Cordless Flash Mode

Cordless Flash Mode is preferable when wireless measuring is desired. In this measuring mode, the meter will go into measurement standby mode (for 90 seconds) to wait for a burst of flash to measure.

Operation

1. On the Measuring screen, touch the [Measuring Mode] icon and select the [Cordless Flash Mode] icon on the Measuring Mode Selection screen.

Select the measuring mode. (→ P23)

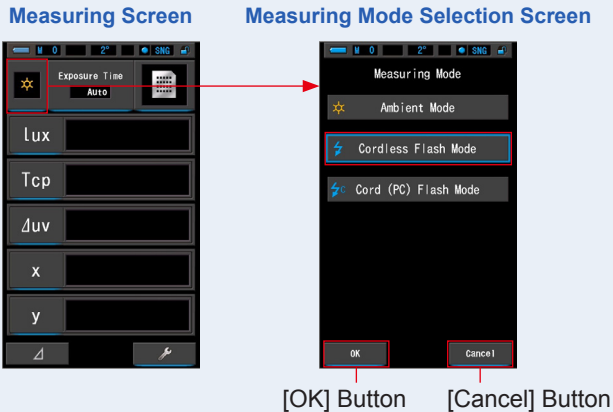

2. Touch the [OK] button.

Confirms and returns to the Measuring screen.

To return to the Measuring screen without confirming, touch the [Cancel] button.

3. Touch the [Shutter Speed] indication on the Measuring screen.

Set the shutter speed used for measurements. (► P26)

Match the blue background with the desired shutter speed.

Measuring Screen

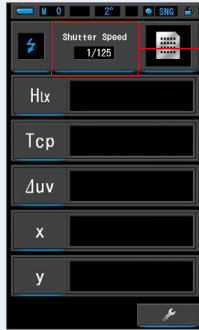

Shutter Speed Screen

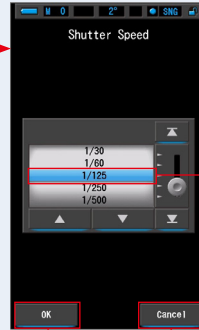

The selected value is indicated by the blue background.

[OK] Button [Cancel] Button

NOTICE



- If you are using this measurement to judge color for photographic reproduction by adjustable camera, be sure to use a shutter speed that synchronize with the camera and flash system.

NOTE

- Shutter speed can also be set in the Tool Box. (► P128)



4. Confirm the light measuring range.

When you return to the Measurement screen,

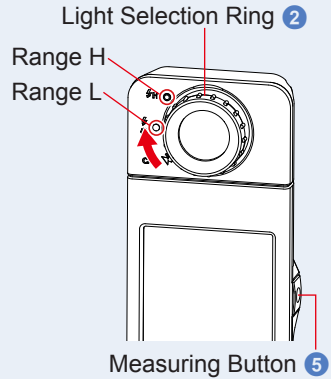
select Range L  or Range H  depending on the brightness of the flash.



NOTE

- Range L : Select when measuring small and low power flash units (lower than 640lx-s), [Over] will appear if flash power is too high. Select Range H.
- Range H : Select when measuring powerful flash units (brighter than 580lx-s) [Under] will appear if flash power is too low. Select Range L.

5. Press the Measuring Button .

The meter will enter measurement standby mode.

While the icon is blinking, manually trigger the flash.

The [Measuring Mode] icon will blink for 90 seconds when measuring.

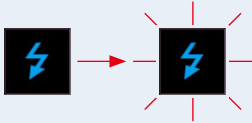

The display panel illumination will dim when the Measuring Button is pressed as the display illumination can affect the reading. This is normal.

When the flash light is fired, the measured value will be displayed for 3 seconds, and the display will return to measurement standby mode.

To cancel standby mode, touch the screen or press the Menu Button .



NOTE

- When the icon stops blinking before triggering the flash, or when you want to restart the 90-second delay cycle again, press Measuring Button  again.

Measurement in Cordless Flash Mode is complete.



CAUTION

- Do not trigger flash while skin or other objects are in contact with the flash tube. Do not touch the flash tube after repeated flashes. (It may cause burns.)
- Do not trigger flash while near the eyes of people or animals. (It may temporarily affect vision.)
- The flash may be triggered suddenly. Because there is the possibility of burns or negative effects on vision, please handle with care.



NOTICE

- When using Cordless Flash Mode, the LCD screen backlight dims during measurement, and the LCD backlight is illuminated for only 3 seconds after measurement. To cancel standby mode, touch the screen or press the Menu Button **6** .
- In case of the following, please follow "5-4 Measurement in Cord (PC) Flash Mode" (➔ P94)
 - If the flash output power is too weak compared to the surrounding light, the meter may not detect the flash output.
 - Pulsed light sources such as fluorescent lights or special lighting could cause the meter to take cordless flash measurements in rare cases.
 - If the Light Receptor **1** detects a sudden and bright change in lighting intensity, the meter may mistakenly take a measurement.
 - Because the light radiated from a flash bulb gradually builds, the meter will not detect the light when used in Cordless Flash Mode.



NOTE

- When using the meter in Cordless Flash Mode, it is possible to mount the meter to a light stand, tripod or similar support using the Tripod Socket **10**.
- [Over] or [Under] will be displayed if the light source illumination is too bright or not bright enough, or if the color temperature is out of the measurement range, when the Measuring Button is pressed. (➔ P102)
In this case, adjust the brightness or color temperature of light source, or switch the light range. (➔ P103)

5-4

Measurement in Cord (PC) Flash Mode

Cord (PC) Flash Mode is preferable when lighting conditions prevent the use of cordless measurements or when certain types of equipment require a physical sync connection.

In Cord (PC) Flash Mode, the meter and flash unit are connected with a Sync Cord (sold separately).

**CAUTION**

- Do not handle this product with wet hands, or leave it in the rain or in a location where it may be splashed with water, submerged, or come into contact with moisture. There is a danger of electric shock in Cord (PC) Flash Mode. This may also result in damage to the product.
- When using flash with high voltage, there is a danger of electric shock if you touch the Sync Terminal 12. Handle the flash with care when using for measurement.

Operation

1. On the Measuring screen, touch the [Measuring Mode] icon and select the [Cord (PC) Flash Mode] icon on the Measuring Mode Selection screen.

Select the measuring mode. (→ P23)

Measuring Screen



Measuring Mode Selection Screen

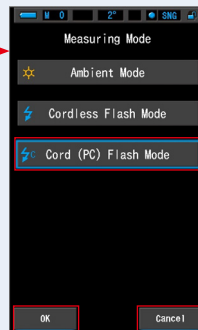

[OK] Button

[Cancel] Button

2. Touch the [OK] button.

Confirms and returns to the Measurement screen.

To return to the Measurement screen without confirming, touch the [Cancel] button.

3. Touch the [T (Shutter Speed)] indication on the Measuring screen.

Set the shutter speed used for measurements. (➔ P26)

Match the blue background with the desired shutter speed.

Measuring Screen



Shutter Speed Screen

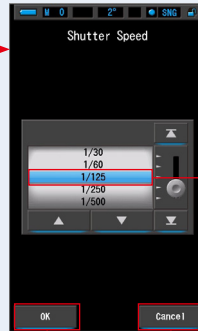

The selected value is indicated by the blue background.

[OK] Button [Cancel] Button

NOTICE

- If you are using this measurement to judge color for photographic reproduction by adjustable camera, be sure to use a shutter speed that synchronize with the camera and flash system.

NOTE

- Shutter speed can also be set in the Tool Box. (➔ P128)

4. Connect the sync cord (sold separately) to the Sync Terminal 12 of the meter.

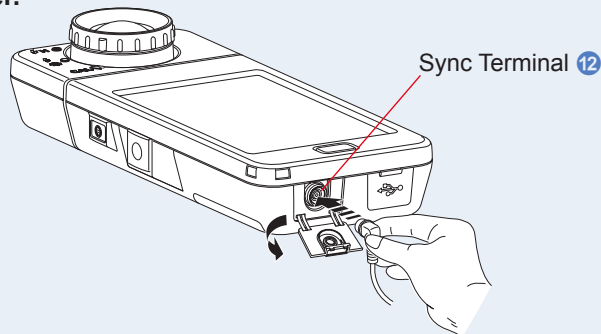

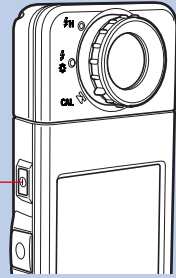

CAUTION

- Depending on the flash equipment used, the flash may be triggered when the sync cord is connected to the Sync Terminal **12** or when operating the Power Button **3**. Because there is the possibility of burns or negative effects on vision, please handle with care.

Power Button **3**



5. Confirm the light measuring range.

When you return to the Measurement screen, select Range L  or Range H  depending on the brightness of the flash.

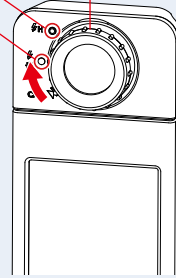
Light Selection Ring **2**
Range H
Range L

Measuring Button **5**

NOTE

- Range L : Select this when measuring small and low power flash units (lower than 640lx·s), [Over] will appear if flash power is too high. Select Range H.
- Range H : Select when measuring powerful flash units (brighter than 580lx·s) [Under] will appear if flash power is too low. Select Range L.

6. Press the Measuring Button **5**.

Measurement will be taken with flash, and the light source values will be displayed.

Because it affects measurement while measuring, the LCD backlight will dim. It is not a defect.

Measurement in Cord (PC) Flash Mode is complete.



CAUTION

- Depending on the flash equipment used, the flash may be triggered when the sync cord is connected to the Sync Terminal ⑫ or when operating the Power Button ③. Because there is the possibility of burns or negative effects on vision, please handle with care.
- Do not trigger flash while skin or other objects are in contact with the flash tube. Do not touch the flash tube after continuous flashes. (It may cause burns.)
- Do not trigger flash while near the eyes of people or animals. (It may temporarily affect vision.)
- The flash may be triggered suddenly. Because there is the possibility of burns or negative effects on vision, please handle with care.



NOTICE

- If the triggering voltage of the flash used is extremely low, the flash may not trigger. In this case, use "5-3 Measurement in Cordless Flash Mode". (➔ P90)
- In the Cordless Flash mode, the measured color temperature may change depending on the shutter speed set for flash measurement and the amount of ambient light present when the measurement is made.





NOTE

- [Over] or [Under] will be displayed if the light source illumination is too bright or not bright enough, or if the color temperature is out of the measurement range, when the Measuring Button is pressed. (➔ P102)
In this case, adjust the brightness or color temperature of light source, or switch the light range. (➔ P103)

5-5

Comparison Function (in Ambient Light Mode only)

In all Display Modes (except Spectrum Comp., CIE1931/1964 Comp. and CIE1976 Comp. modes), when you touch the Delta icon () in the Display mode, it changes to ()

While this mode, the difference between preset reference value and currently being measured value is displayed as long as the Measuring Button  is released.

When the Measuring Button  is released, the preset reference value is displayed in the yellow letter.

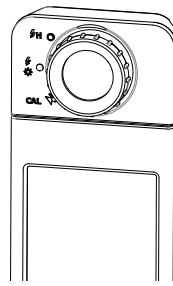
Measuring Button 

Operation

1. Touch the [Preset Selection (2°) (Preset Selection (10°))] button in the Tool Box.

The Preset Selection screen will be displayed.

Tool Box Screen

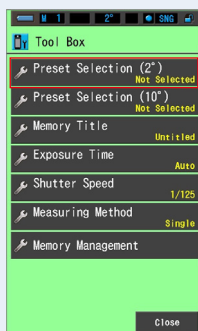

Preset Selection (2°) Screen

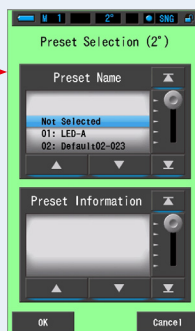

 **NOTICE**

- A Preset value must be created and saved in the Preset Editing function under the "Setting Mode" icon before use. Preset Selection buttons will be grayed out until settings are created.

2. Select desired preset no. (1 ~ 5).

Match the blue background with the desired shutter speed.

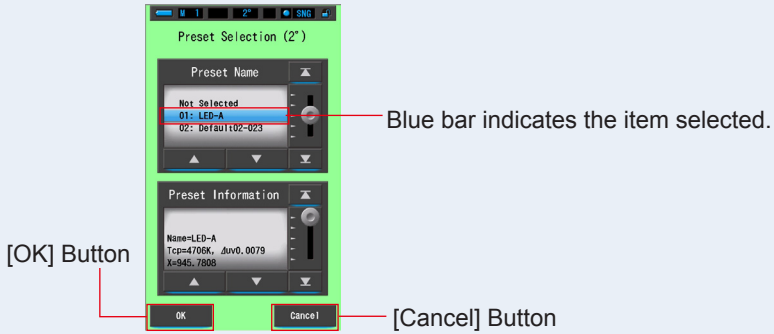
Preset Selection Screen



- Be sure to set Preset Selection to "Not Selected" when no correction is desired.

3. Touch the [OK] button.

Confirm and return to the Measurement screen.

To return to the Measurement screen without confirming, touch the [Cancel] button.

Tool Box Screen

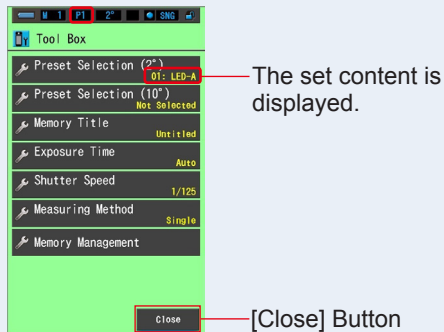

4. Touch the [Close] button.

The preset is set.

Returns to the Measurement screen.

The selected status will be displayed on the status bar.



5. Touch the [Delta] icon ().

The [Delta] icon will change to ().

Measuring Screen





Measuring Screen



[Delta] Icon

6. Hold the Measuring Button .

While the [Delta] icon is activated (), the difference with the preset reference value is displayed as long as the Measuring Button  is pressed.

Measuring Screen



7. Comparison Function is complete.



When the Measuring Button **5** is released, the preset reference value is displayed.

8. Touch the [Delta] icon ().

The last measured values are displayed, and the [Delta] icon () will be deactivated.



NOTE

- If Preset is not selected, the Comparison Function does not start even when you touch the Delta icon ().
- The [Delta] icon () is deactivated when the power is turned OFF.
- When the [Delta] icon is displayed, the Memory Button **7** is disabled.

5-6

When [Over] or [Under] is Displayed

When [Over] or [Under] is displayed, the light source is out of measuring range.



5-6-1

Display of [Over] or [Under]

When [Over] is displayed:

If the indicated values are higher than the maximum measuring range, [Over] is displayed.



When measuring ambient light, decrease the brightness of the illumination.

When measuring flash light, turn the Light Selection Ring ②, and change the range from L ⚡ () to H ⚡H (), or lower the flash output power. ⚙️

When [Under] is displayed:

If the indicated values are lower than the minimum measuring range, [Under] is displayed.

When measuring ambient light, increase the brightness of the illumination.

When measuring flash light, turn the Light Selection Ring ②, and change the range from H ⚡H () to L ⚡ (), or raise the flash output power. ⚙️

Light Selection Ring ②

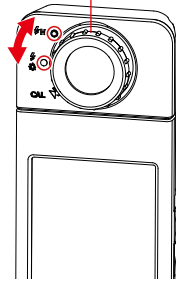





Measuring Button ⑤

**NOTE**

- Measurement and display will take longer in light levels below 30lx. The LCD illumination will normally switch off during measurements to avoid influence to measurements.

5-6-2 Changing the Light Range

Change and use the light range depending on the brightness of the flash.

Light Selection Ring (Status Bar Display)			Content
Dark Calibration Position		CAL	Select for dark calibration only. Measurement cannot be made in this position.
Range L			Select for ALL ambient light measurement, and low power flash units (lower than 640lx·s/59.5fc·s)
Range H			Select for powerful flash units (brighter than 580lx·s/53.9fc·s) only.

Turn the Light Selection Ring ② and select the desired range.
The set range will be displayed on the LCD screen's status bar.

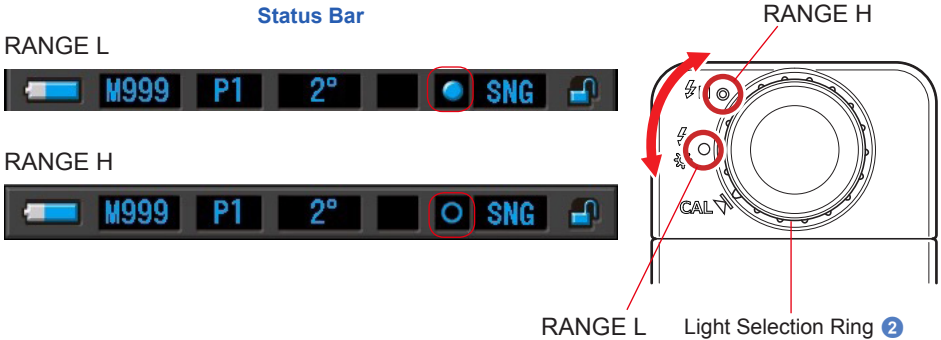

6. Measurement Tool [Tool Box] Screen

Selecting Screens from the Tool Box

Touch the [Tool Box ()] icon in the Measuring screen to display the Tool Box screen. (→ P16) You can select screens from the Tool Box as follows.

Exposure Time (→ P126)



Shutter Speed (→ P128)

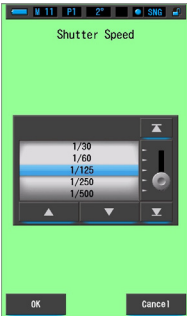

Measuring Method (→ P130)

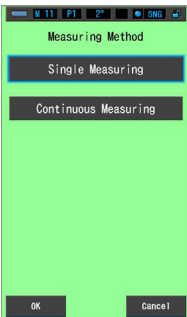

Tool Box

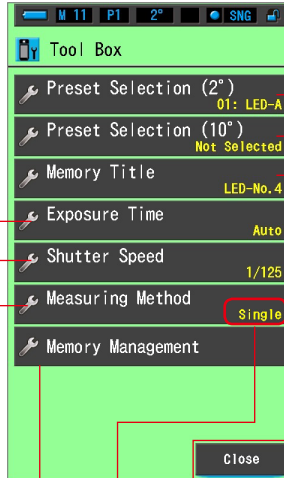

The set content is displayed in yellow letter at the lower right hand corner of the button.

Return to the [Measuring screen] by touching the [Close] button.

Memory Management (→ P113)



Preset Selection (2°) (→ P105)

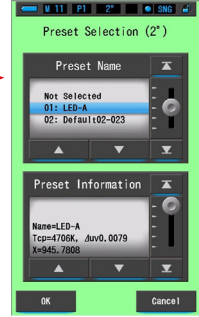

Preset Selection (10°) (→ P105)



Memory Title (→ P109)



6-1 Setting Preset Contents [Preset Selection] Screen

You can select a previously created Preset value from Preset Selection in the Tool Box.

Select a preset item of Preset Selection (2°) or Preset Selection (10°).

If the "Preset Selection List" is set to be displayed in the "Preset Editing" function of "Setting", only these preset items are displayed on the drum.

Preset Selection (2°) Screen

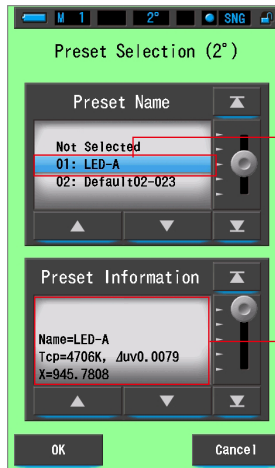

Presets which are set to "Displayed" in the "Preset Editing" in "Setting" screen appear here.

Contents of selected Preset is displayed.

Operation

1. Touch the [Preset Selection (2°) (Preset Selection (10°))] button in the Tool Box.

The Preset Selection screen will be displayed.

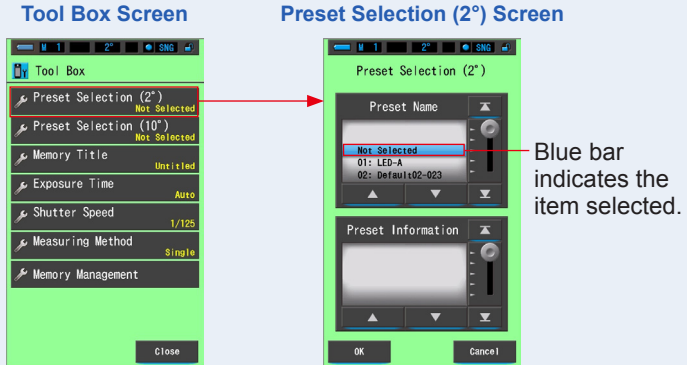

NOTICE

- A Preset value must be created and set to “Displayed” in the Preset Editing function under the “Setting Mode” icon before it can be used. Preset Selection buttons will be grayed out until settings are created and set to “Displayed”. (➔ P158)

2. Select desired preset no. (01 ~ 05).

Touch Up/Down buttons or move slide to position the desired Preset under the blue bar.

Preset Selection (2°) Screen

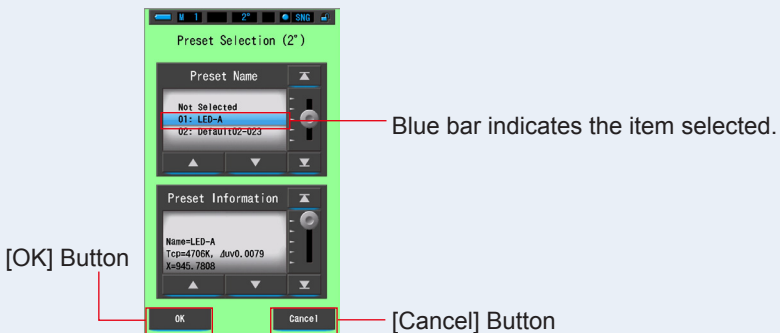

NOTICE

- Be sure to set Preset Selection to "Not Selected" when no correction is desired.

3. Touch the [OK] button.

Confirm and return to the Measuring screen.

To return to the Measurement screen without confirming, touch the [Cancel] button.

Tool Box Screen

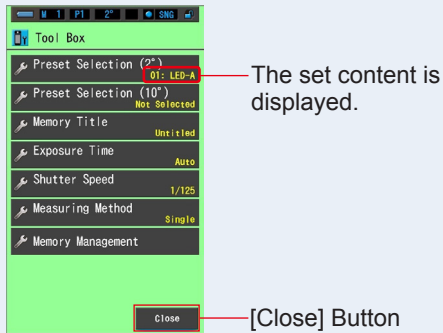

4. Touch the [Close] button.

Returns to the Measuring screen.

The selected status will be displayed on the status bar.



The preset is set.

6-2 Using the Memory Function

The memory function enables storing light source data for single sources and groups of sources for recall at any time. Up to 999 measurements can be stored. Memory function also enables naming or renaming the title of memory and clearing the stored value.

Memory Management Screen



Tool Box Screen



Memory Title Screen

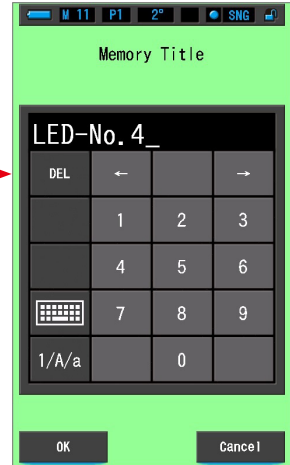

Memory Recall Screen



Memory Edit Screen



Renaming Memory Title

Clearing Memorized Value

6-2-1

Naming Measurement Values Being Memorized [Memory Title] Screen

You can create special titles for memorized values to make them easier to select, view and use data later.

To use this function the order of operation:

- * Create memory title
- * Measure light source
- * Press Memory button **7** to memorize

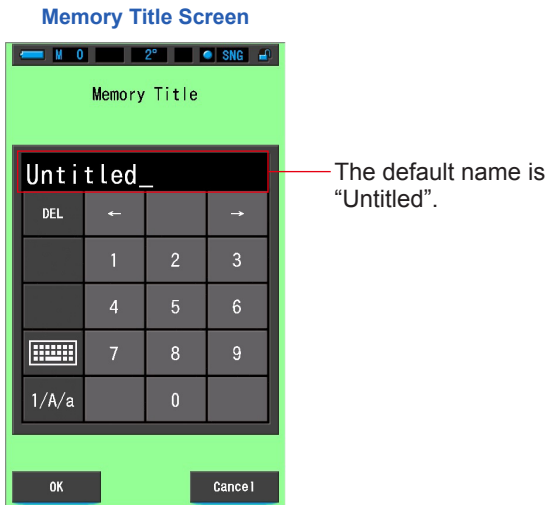

NOTE

- A title can be a maximum of 16 alphanumeric characters.
- More than one measurement can be stored under one title.
- Up to 999 titles can be created.

Operation

1. Touch and select the [Memory Title] button in the Tool Box.
The Memory Title screen will be displayed.



2. Enter the memory title. (→ P18)

Use the keyboard to create a name for the measured light.

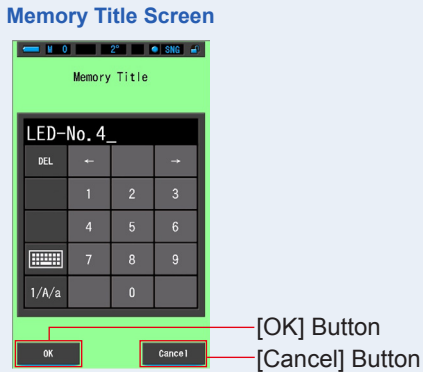

3. Touch the [OK] button.

Confirms and returns to the Tool Box screen.

To return to the Tool Box screen without confirming, touch the [Cancel] button.

4. Touch the [Close] button.

Returns to the Measuring screen.

Tool Box Screen

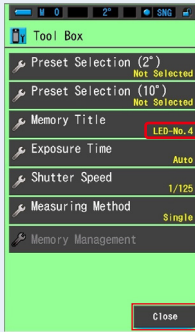

[Close] Button

The memory title is entered.



NOTICE

- The memory title needs to be entered before memorizing.
- The memory title can be changed after memorizing in Memory Management function. (➔ P118)

5. Measure light.

Press Measuring Button ⑤ to take a measurement.

The Light Selection Ring ② should be set to L () when taking ambient light measurements.

When measuring flash units, select Range L () or Range H () depending on the brightness of the flash. (➔ P102, ➔ P103)

Light Selection Ring ②

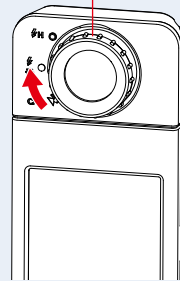

Measuring Button ⑤

Measuring Screen

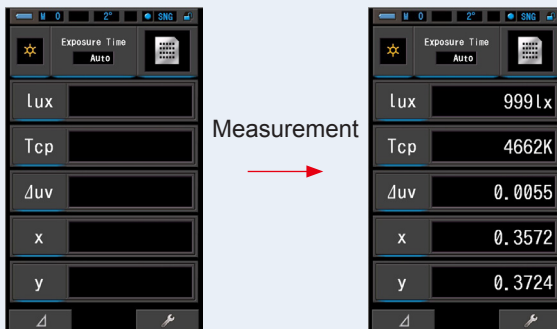

6. Press Memory Button 7 to memorize light source values and link the reading to the created title name.

The Memory reflected on the status bar.

Status Bar

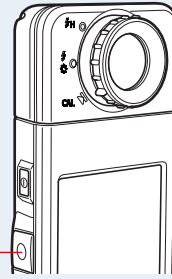
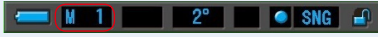

Memory Button 7

6-2-2 Recalling Measurement Results [Memory Recall] Screen

The Memory Recall screen enables selecting a specific Title and Memory number to view and inspect values stored in the memory under any Display Mode.

Ex.) Memory Recall Spectrum Mode Screen

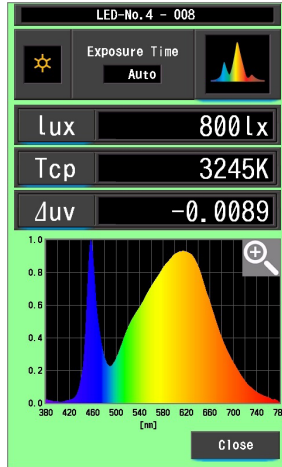

Operation

1. Touch the [Memory Management] button in the Tool Box.
Memory Management screen will be displayed.
2. Select the "Title" and "Memory" to recall with the blue background position.

Tool Box Screen

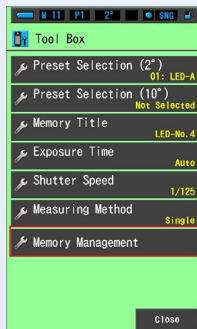

Memory Management Screen

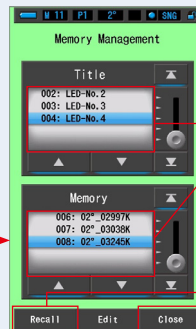

Move Title and then Memory number into the blue background to make a selection.

[Recall] Button
[Close] Button

3. Touch the [Recall] button.

The meter will display the Display Mode viewed at the time the light source was measured.

To return to the Tool Box screen without confirming, touch the [Close] button.

4. Confirm the memory contents.

Display Mode at the time when measured appears.

In Memory Recall Mode, the background color becomes green.

Memory Title of recalled value appears every two seconds on the status bar.

Ex.)

Memory Recall Spectrum Mode Screen

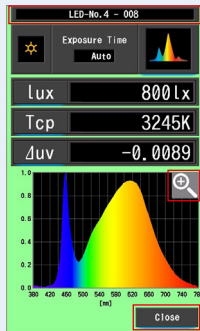

Spectrum Distribution Graph Enlarged Display

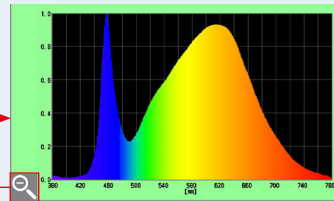

[Close] Button

NOTICE

- If the Memory Button is pressed while in Spectrum Comparison mode, recalled data will be displayed on the Spectrum Display screen.
- In Memory Recall Mode, measurement cannot be made.

5. Touch the [Close] button.

Returns to the Memory Management screen.

Changing Memory Recall Mode Display

Touch one of the [Display Mode] icons in Memory Recall Mode, and the specified display with memorized data for that Memory Recall Mode will appear. In Memory Recall Mode, Memory Title of recalled value appears every two seconds on the status bar.

**Memory Recall Mode
Display Mode Selection Screen (2°)**

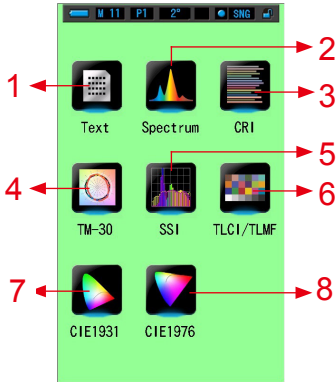

**Memory Recall Mode
Display Mode Selection Screen (10°)**

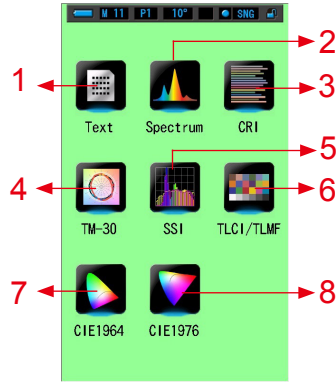

**1 Memory Recall Mode
Text Mode**



**2 Memory Recall Mode
Spectrum Mode**

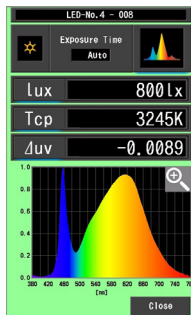

**3 Memory Recall Mode
CRI Mode**

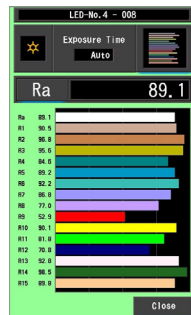

**4 Memory Recall Mode
TM-30 Mode**

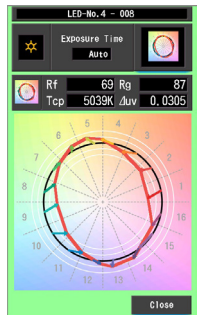

**5 Memory Recall Mode
SSI Mode**

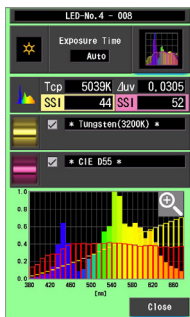

**6 Memory Recall Mode
TLCI/TLMF Mode**





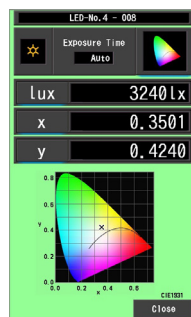



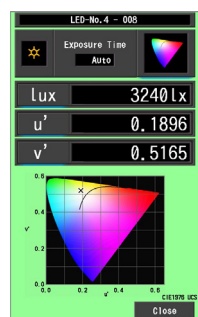

**7 Memory Recall Mode
CIE1931 (CIE1964) Mode**



**8 Memory Recall Mode
CIE1976 Mode**



No.	Display Mode Icon	Part Name	Description	
1	 Text	Memory Recall Mode [Text] Icon	Displays user-selected 5 items in numeric values. (➔ P35)	
2	 Spectrum	Memory Recall Mode [Spectrum] Icon	Displays 3 user-selected values and spectrum distribution graph. (➔ P38)	
3	 CRI	Memory Recall Mode [CRI] Icon	Displays the selected average CRI (RA) or individual CRI (R1 ~ R15). Each CRI is displayed in a bar graph. (➔ P41)	
4	 TM-30	Memory Recall Mode [TM-30] Icon	Displays four current measurement values (Rf, Rg, Tcp, Δuv) and color vector graphic. (➔ P44)	
5	 SSI	Memory Recall Mode [SSI] Icon	Compares the current measurement value and up to 2 reference values (color temperature and Δuv), and displays SSI index with the SSI spectrum graph. (➔ P46)	
6	 TLCI/TLMF	Memory Recall Mode [TLCI/TLMF] Icon	Displays the current measurement values and memorized values (in color temperature and Δuv), TLCI and TLMF with spectrum graph. (➔ P57)	
7	 CIE1931	 CIE1964	Memory Recall Mode [CIE1931 (CIE1964)] Icon	Displays the measured result of the selected memory on the CIE1931 chromaticity diagram for a 2° viewing angle (or CIE1964 chromaticity diagram for a 10° viewing angle). (➔ P62)
8	 CIE1976	Memory Recall Mode [CIE1976] Icon	Displays the measured result of the selected memory on the CIE1976 chromaticity diagram. (➔ P64)	



NOTE

- The contents of Memory Recall Mode display the selected display items in the current Display Modes instead of display items at the time when memorized.

Operation

1. Touch the [Display Mode] icon on the Memory Recall Mode.

Display modes of Memory Recall Mode will be displayed. Memory Title of recalled value appears every two seconds on the status bar.

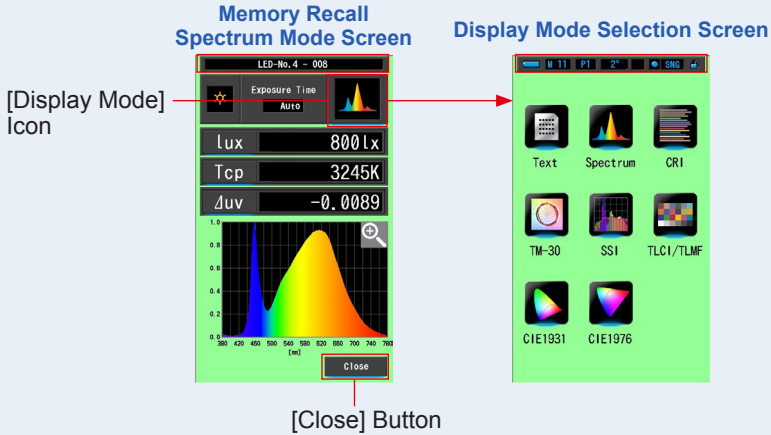

2. Touch the desired [Display Mode] icon to select display. Switches to each display mode screen.

Memory Recall Text Mode Screen



3. Touch the [Close] button.

Returns to the Memory Management screen.

6-2-3

Renaming Memory Title [Memory Rename] Screen

The title of measurements of the memory can be changed.

Memory Rename Screen

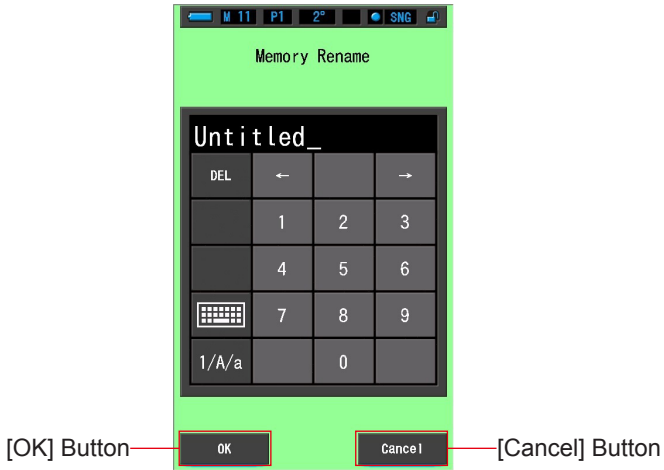

Operation

1. Touch the [Memory Management] button in the Tool Box. Memory Management screen will be displayed.

Tool Box Screen

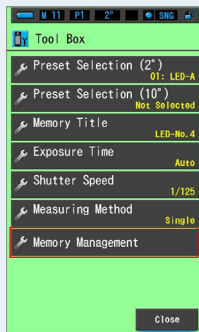

Memory Management Screen

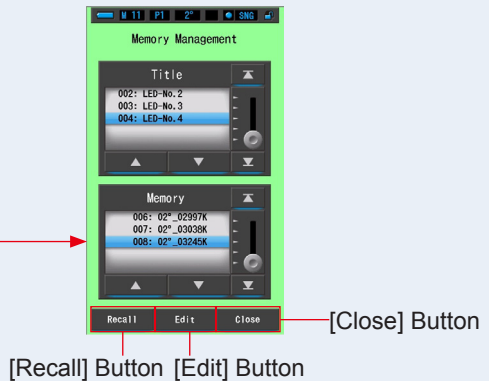

2. Touch the [Edit] button.

Memory Edit screen will be displayed.

Memory Management Screen



[Edit]
Button

Memory Edit Screen

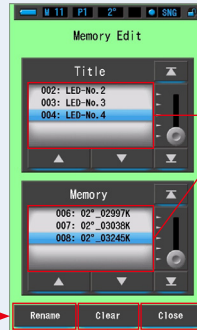

Move Title and then Memory number into the blue background to make a selection.

[Close] Button

[Rename] Button [Clear] Button

3. Select the "Title" and "Memory" to rename with the blue background positions.

4. Touch the [Rename] button.

Memory Rename screen will be displayed.

Memory Edit Screen



[Rename]
Button

Memory Rename Screen



5. Enter the Memory Title to rename. (→ P18)

Use the keyboard to create a name for the memorized value.

Memory Rename Screen

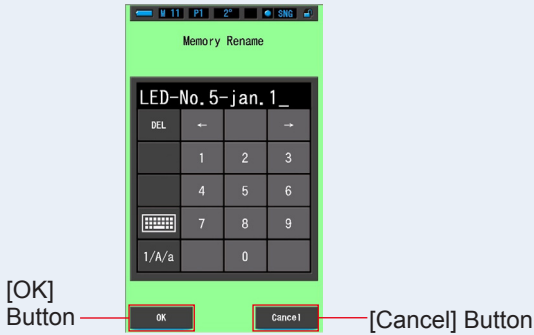

6. Touch the [OK] button.

Confirm and return to the Memory Edit screen.

To return to the Memory Edit screen without confirming, touch the [Cancel] button.

The memory title is entered.

7. Touch the [Close] button.

Close and return to the Memory Management screen. Touch the [Close] button to return to Measuring screen.

Memory Edit Screen

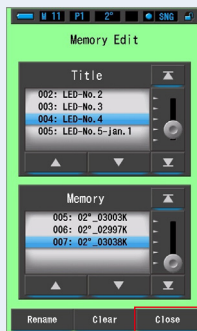

Memory Management Screen

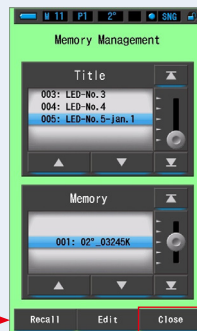

[Close] Button

[Close] Button

6-2-4

Deleting Saved Measurement Results [Memory Clear] Screen

You can delete memorized measurement values individually or every Memory Title at once.

In Memory Clear, titles and memory contents (memory numbers and measurement values) are displayed in the registered order.

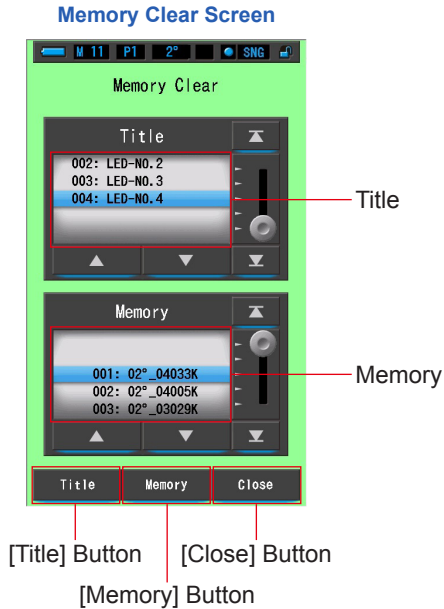

Operation

1. Touch and select the [Memory Management] button in the Tool Box.
The Memory Management screen will be displayed.

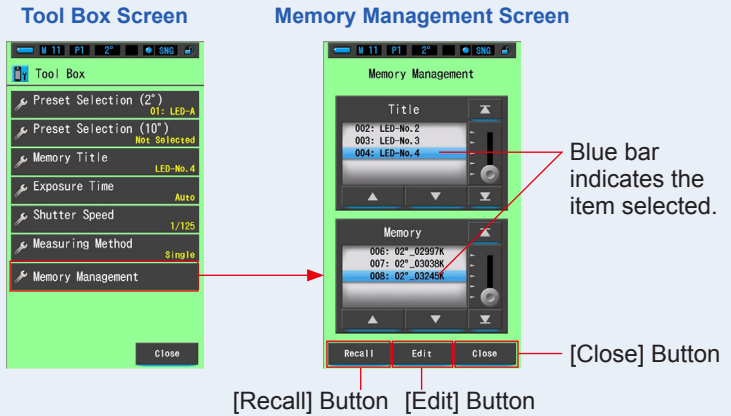

2. Touch the [Edit] button.
Memory Edit screen will be displayed.

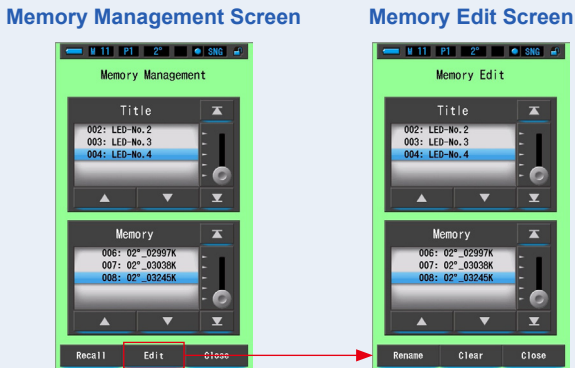

3. Select the "Title" and "Memory" to clear with the blue background positions.

4. Touch the [Clear] button.

Memory Clear screen will be displayed.

Memory Edit Screen



[Clear] Button

Memory Clear Screen

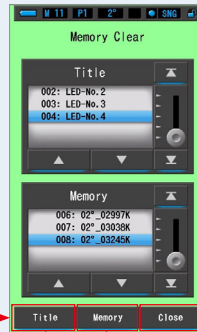

[Close] Button

[Title] Button [Memory] Button

[Erasing Individual Values]

1. Select the Title to display the memorized value you want to delete. Then select the specific light source value under that title, if more than one value has been memorized.

2. Touch the [Memory] button.

This will display the Memory Clear Confirmation screen. "Remove the selected memory data. Are you sure?" will be displayed.

Memory Clear Screen

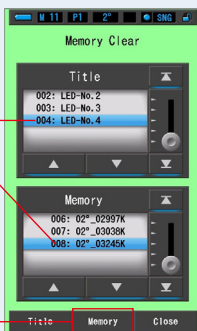

Select Title then the Memory that you want to clear.

[Memory] Button

Memory Clear Confirmation Screen

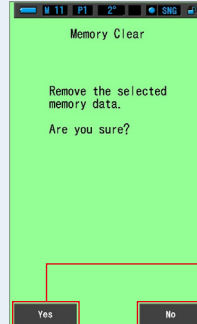

[Yes] Button

[No] Button

3. Touch the [Yes] button.

“Deleting Memory. Please wait.” will appear while the memory is being deleted. After the memory is cleared, the meter will return to the Memory Clear Screen.

While the progress bar is running, the deletion is in progress. The process may require time depending on the number of memories to be deleted. Do not perform other work. You can clear (delete) additional memories by repeating steps 1-3.

If you decide not to delete a memory, touch the [No] button to return to the Memory Clear Screen.

Memory Clear Processing Screen

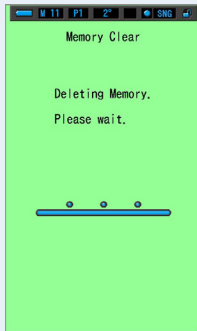

Memory Clear Screen

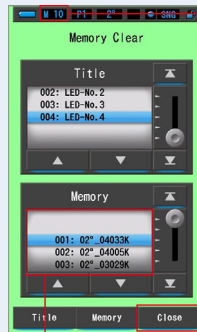

The number of memories will change.

[Close] Button

The selected memory will be deleted, and the numbers after the selected number will decrease by one.

4. Touch the [Close] button.

Returns to the Memory Edit screen.

Touch the [Close] button until returning to Measuring screen.

[Erasing the Memory Title]

1. Match the "Title" to be deleted with the blue background positions.

Select the "Title" to be deleted.

2. Touch the [Title] button.

This will delete the title. All the memory data linked to the title will be deleted.

This will display the Memory Clear Confirmation screen. "Remove the selected memory title. Are you sure?" will be displayed.

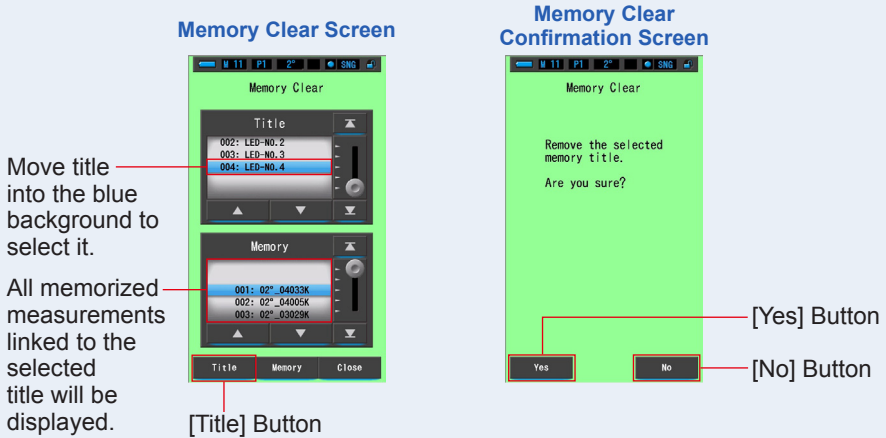

3. Touch the [Yes] button.

"Deleting Memory. Please wait." will be displayed. Returns to the Memory Clear screen after deletion.

While the progress bar is running, the deletion is in progress. The process may require time depending on the number of memories to be deleted. Do not perform other work.

If you do not want to delete the memorized values, touch the [No] button. Returns to the Memory Clear screen.

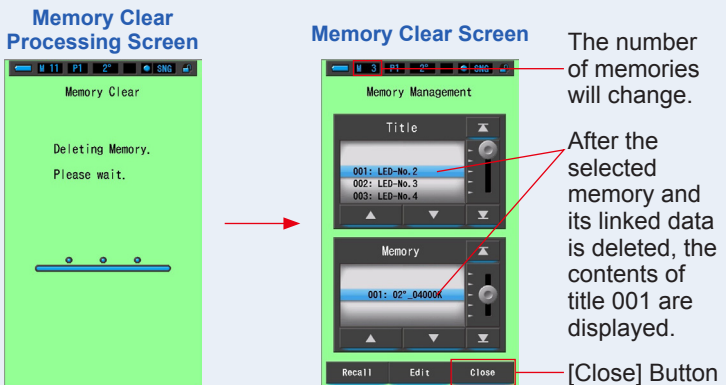

4. Touch the [Close] button.

Returns to the Memory Edit screen. Touch the [Close] button until returning to Measuring screen.

6-3

Selecting Exposure Time [Exposure Time] Screen

Set a Exposure Time for ambient measurement.

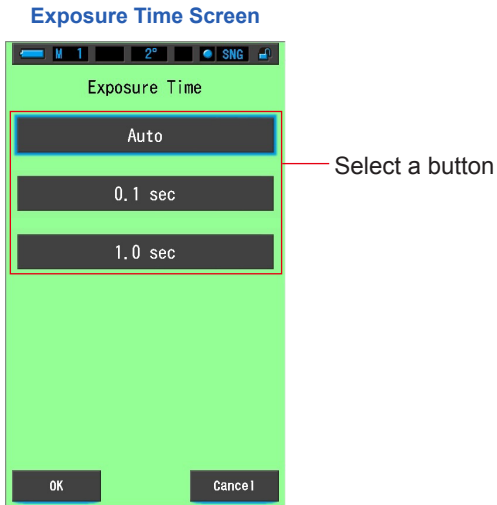

Operation

1. Touch the [Exposure Time] button in the Tool Box.
The Exposure Time screen will be displayed.

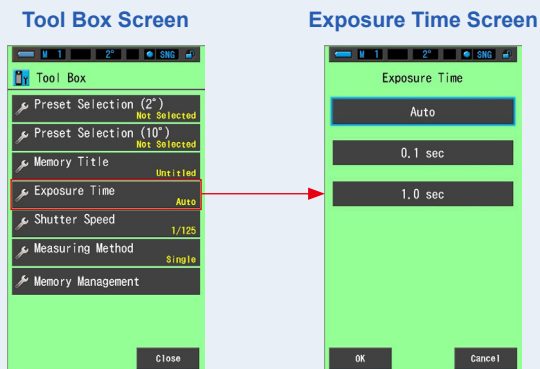

2. Set a Exposure Time for ambient measurement.

Select Auto, 0.1 sec or 1.0 sec.

Exposure Time Screen

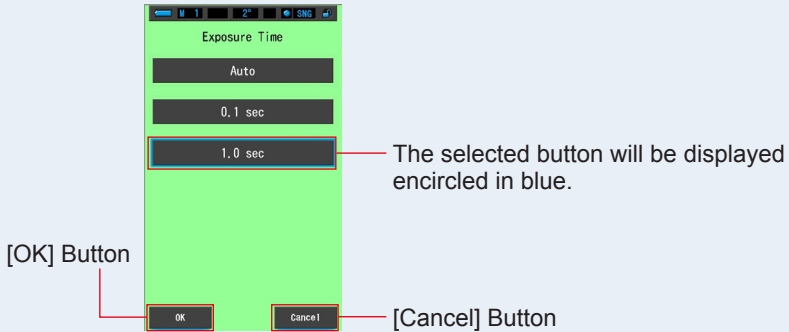

3. Touch the [OK] button.

Confirms and returns to the Tool Box screen.

To return to the Tool Box screen without setting, touch the [Cancel] button.

The selected status will be displayed on the Tool Box.

Tool Box Screen

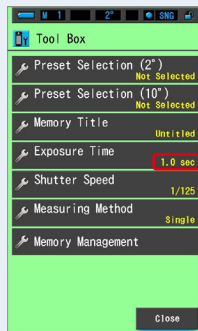

The selected exposure time is displayed on the Measuring screen.

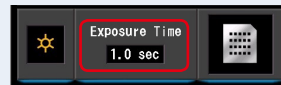

The selected exposure time is displayed.

The Exposure Time has been set for a fixed 1.0 second measurement.

NOTE

- In Auto mode, the C-7000 automatically selects among 15 measuring times, determined by the illumination available, to achieve a proper result in a convenient way.
Two fixed reading times are available to enable exact comparison of multiple measurements.
When measuring high illuminance levels, set the Exposure Time to 0.1 sec.
When taking measurements in low illuminance, set the Exposure time for 1.0 sec.

6-4

Setting the Shutter Speed [Shutter Speed] Screen

Set a shutter speed that is appropriate for the intended flash-ambient measurement.

Shutter Speed Screen

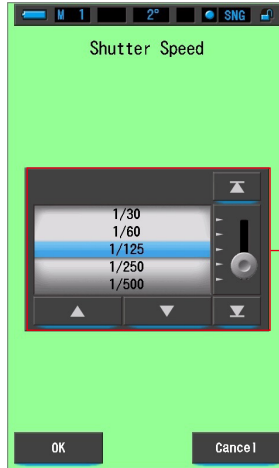

Select a shutter speed in the list.

Operation

1. Touch the [shutter Speed] button in the Tool Box
The Shutter Speed screen will be displayed.

Tool Box Screen

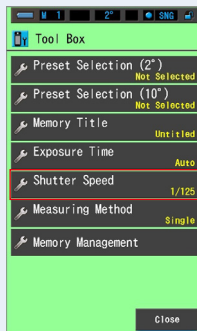

Shutter Speed Screen

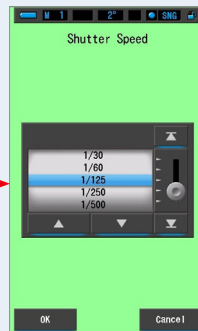

2. Select the desired shutter speed.

Shutter Speed Options (➔ P26)

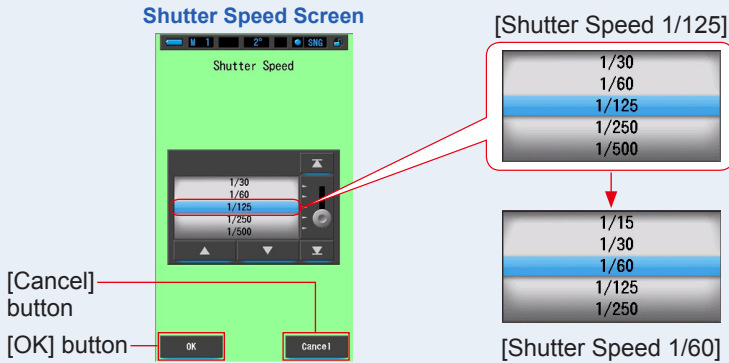

3. Touch the [OK] button.

Confirms the settings, and returns to the previous Measuring screen.

Touch [Cancel] to return to the previous measuring screen without setting.

The shutter speed is set.

Tool Box Screen

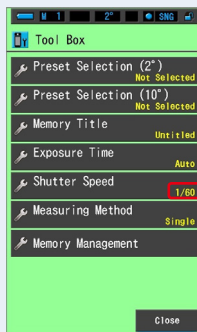

The selected shutter is displayed on the Measuring screen



The selected shutter speed is displayed.

6-5

Selecting Measuring Method [Measuring Method] Screen

Set a measuring Method from single measurement or continuous measurement. Single measurement enables to measure at the time when the Measuring button ⑤ is pressed.

Continuous measurement can be made by pressing the Measuring button ⑤ to start measuring, and pressing the Measuring button ⑤ again to complete measuring to display the measured value continuously during this duration.

Measuring Method Screen

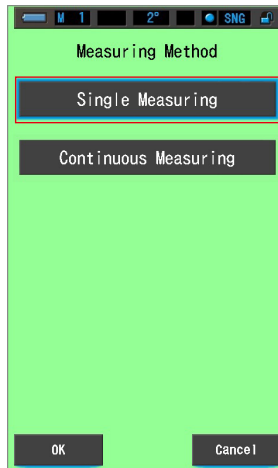

Select the measurement method in the list.

Operation

1. Touch the [Measuring Method] button in the Tool Box

The Measuring Method screen will be displayed.

Tool Box Screen

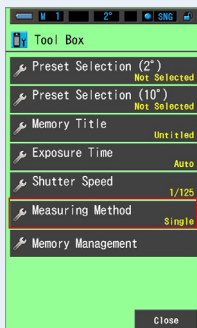

Measuring Method Screen

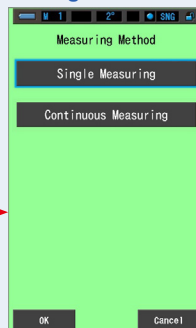

2. Select the desired measuring method.

Select **Single Measurement (SNG)** or **Continuous Measurement (CNT)**.

Measuring Method Screen

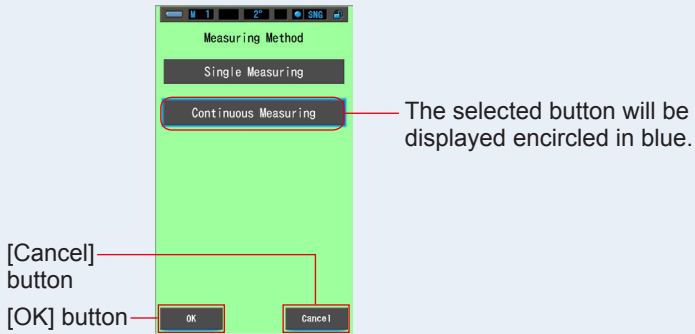

3. Touch the [OK] button.

Confirms the settings, and returns to the previous Measuring screen.

Touch [Cancel] to return to the previous measuring screen without setting.

Measurement method has been set.

Tool Box Screen

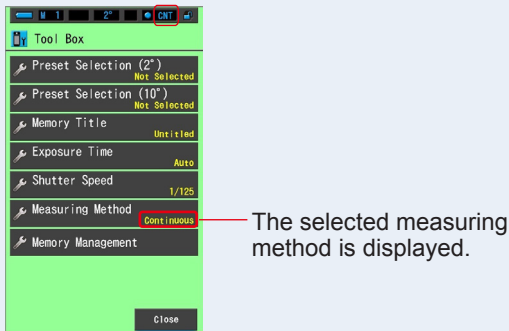

NOTE

[Single Measurement]

- Measured value at the time when the Measuring button **5** is pressed is displayed.
- It is useful to measure multiple light sources and memorize them.

[Continuous Measurement]

- Press the Measuring button **5** to start measuring, and press the Measuring button **5** again to complete measuring to display the last measured value.
- It is useful to measure one light source to check the variation or evenness of light source.

[Single Measurement (SNG)]

1. When the single measurement is selected, [SNG] appears on the status bar.

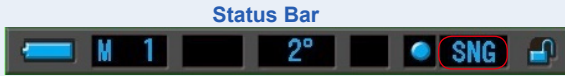

2. Single measurement displays the measure value at the time when the Measuring button ⑤ is pressed.

NOTE

- [Over] or [Under] will be displayed if the light source illumination is too bright or not bright enough, or if the color temperature is out of the measurement range, when the Measuring Button is pressed. (➔ P102)
In this case, adjust the brightness or color temperature of light source, or switch the light range. (➔ P103)

[Continuous Measurement (CNT)]

1. When the continuous measurement is selected, [CNT] appears on the status bar.



2. Continuous measurement can be made by pressing the Measuring button ⑤ to start measuring, and pressing the Measuring button ⑤ again to complete measuring to display the measured value continuously during this duration.

NOTICE

- To get accurate color from a light source, make sure not to get bounced or reflected light from a colored surface, or another light to the Light Receptor ①
- Take a measurement by facing the Light Receptor towards the light source.
- During the continuous measurement, auto power off function is disable.

NOTE

- [Over] or [Under] will be displayed if the light source illumination is too bright or not bright enough, or if the color temperature is out of the measurement range, when the Measuring Button is pressed. (➔ P102)
In this case, adjust the brightness or color temperature of light source, or switch the light range. (➔ P103)

7. Meter Settings [Setting] Screen

7-1 Setting Items

Here you can customize your meter for your preference in advance.

Display Mode Selection Screen (2°) Page 1 Display Mode Selection Screen (2°) Page 2

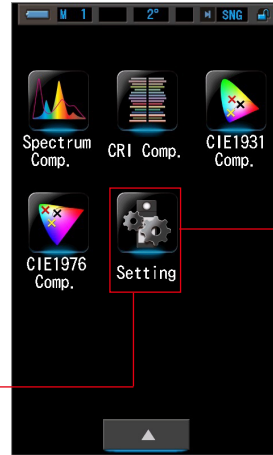
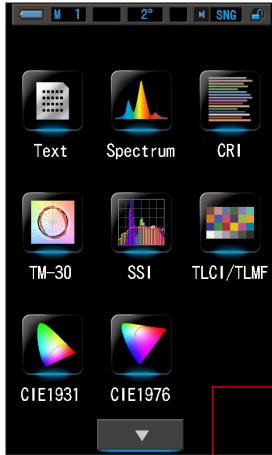

[Setting] Icon

Setting
Page 1 Screen



To page 2

Setting
Page 2 Screen



To page 1

[Close] Button

* Models sold in some countries do not display illuminance and exposure in "fc (fc-s)" due to legal restrictions. In this case, Unit of Illuminance is not displayed.

Operation

1. Touch the [Setting] icon on the Display Mode Selection screen.
Setting will be displayed.
2. Touch the one step icons [▲][▼] to display the desired page.
3. Touch the desired setting name.

That setting screen will be displayed.

When the [Close] button is touched, the display returns to the Display Mode Selection screen.



NOTE

- Pressing the Menu Button ⑥ will exit the settings and return to the Display Mode Selection screen.

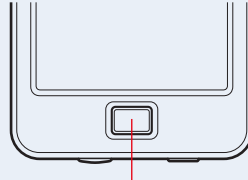

Menu Button ⑥

7-1-1 Item List

The Setting screen items are as follows.

Item Name	Description
Customize	
Unit of Illuminance	Select the unit from lx(lx·s), fc(fc·s) or both when measuring illuminance. (➡ P138)
Spectrum Y-axis Scale	Select relative, auto, or spectral irradiance. (➡ P140)
Auto Power Off	Select the time before the power automatically turns off after last use (5min, 10min, 20min, No Auto Power Off). When No Auto Power Off is set, the automatic power OFF function is not activated. (➡ P143)
Backlight Brightness	Select the LCD backlight brightness from dark, normal, or bright. (➡ P145)
Auto Dimmer	Select the time before the backlight dims after last use to save power or adjust the visibility under the surrounding light condition. (5sec, 10sec, 20sec, 40sec, 60sec, No Dimmer) (➡ P147)
Language	Select the language displayed on the touch panel from English, Japanese or Chinese. (➡ P149)
Reset Customized Items	Initialize (reset) only contents of "Customize" in Setting to the factory default (6 items for C-7000). (➡ P151)
Edit a preset	
Preset Editing	Edit a preset for 2° or 10° separately. (➡ P152)
Dark Calibration	
Dark Calibration	Perform dark calibration. (➡ P186)
Display the information	
Product Information	Display the product Information. (➡ P189)
Regulation	Display the compliant regulation. (➡ P191)

* Models sold in some countries do not display illuminance and exposure in "fc (fc·s)" due to legal restrictions.

7-2

Customize

You can set the display contents of 6 items in Customize Setting to customize your meter for your preference.

The current setting for each item is displayed in yellow letters.

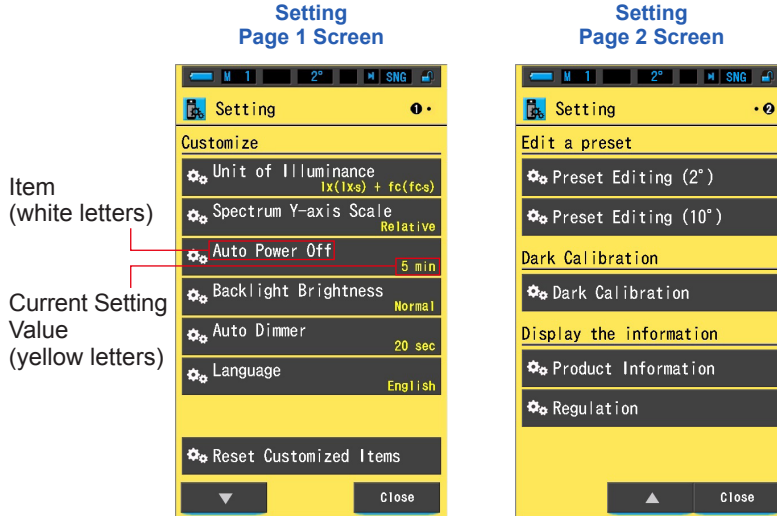

Operation

1. Touch the [Setting] icon on the Display Mode Selection screen.
Setting will be displayed.
2. Touch the one step icons [▲][▼] to display the desired page.
3. Touch the desired item.

The item screen will be displayed.

When the [Close] button is touched, the display returns to the Display Mode Selection screen.

7-2-1 Item Specifications

The specifications of each "Customize" item is as follows.

No.	Setting Name	Item						(Default)
1	Unit of Illuminance*	lx(lx·s)+ fc(fc·s)	lx(lx·s)	fc(fc·s)	-	-	-	lx(lx·s)+ fc(fc·s)
2	Spectrum Y-axis Scale	Relative	Auto	Spectral Radiant Intensity 1.0μW to 100W·m ⁻² ·nm ⁻¹				Relative
3	Auto Power Off	5min	10min	20min	No Auto Power Off	-	-	5min
4	Backlight Brightness	Dark	Normal	Bright	-	-	-	Normal
5	Auto Dimmer	5sec	10sec	20sec	40sec	60sec	No Dimmer	20sec
6	Language	English	Japanese	Chinese	-	-	-	Selected by default
7	Reset Customized Items	When you touch the [OK] button, the Setting contents will be reset to factory default.						-

* Models sold in some countries do not display illuminance and exposure in "fc (fc·s)" due to legal restrictions.

7-2-2

Selecting the Unit of Illuminance

Select the unit when measuring illuminance.

* Models sold in some countries do not display illuminance and exposure in "fc (fc·s)" due to legal restrictions. In this case, "Unit of Illuminance" button will not appear in Setting screen.

Unit of Illuminance Screen

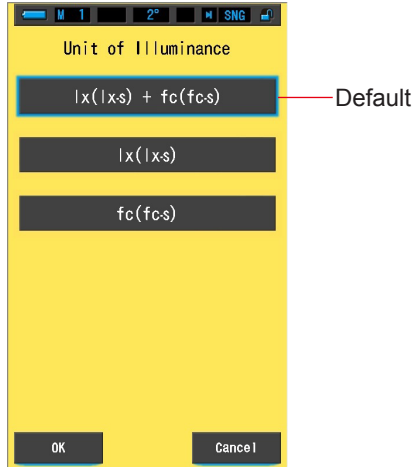

Operation

1. Touch the item [Unit of Illuminance] button on page 1 of Setting screen.

The unit of illuminance will be displayed.

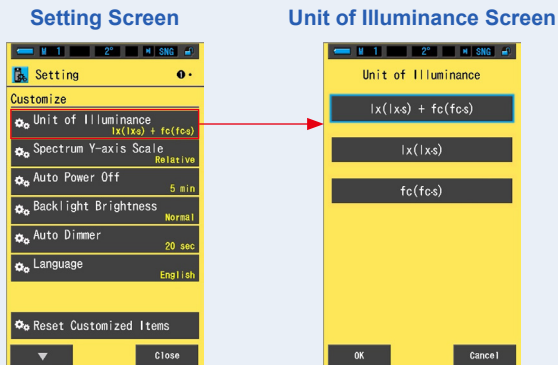

2. Touch the [Unit of Illuminance] button.

Select the unit of illuminance.

Unit of Illuminance Screen

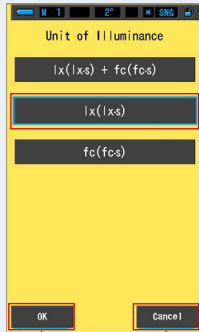

The selected button will be displayed encircled in blue.

[OK] Button

[Cancel] Button

3. Touch the [OK] button.

Confirms the settings, and returns to Setting screen.

To return to the Setting screen without confirming, touch the [Cancel] button.

Setting Screen

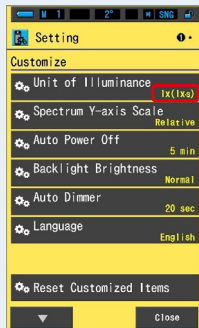

The set content is displayed.

The unit of illuminance is set.

7-2-3

Selecting the Spectrum Y-axis Scale

Select Relative, Auto, or any specific number of spectral irradiance as the maximum display value for the spectrum Y-axis.

Spectrum Y-axis Scale Screen

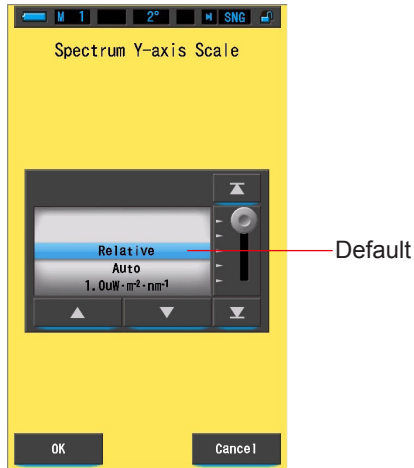

Operation

1. Touch the item [Spectrum Y-axis Scale] button on page 1 of Setting screen.

The maximum display value of the spectrum Y-axis scale will be displayed.

Setting Screen

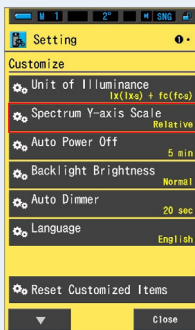

Spectrum Y-axis Scale Screen



2. Select the desired spectrum Y-axis scale.

Select from Relative, Auto, or any specific number of spectral irradiance.

Spectrum Y-axis Scale Screen

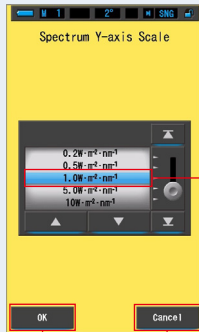

Blue bar indicates the value selected.

[OK] Button

[Cancel] Button

3. Touch the [OK] button.

Confirms the setting, and returns to Setting screen.

To return to the Setting screen without confirming, touch the [Cancel] button.

Setting Screen

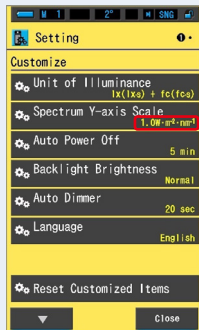

The set content is displayed.

The spectrum Y-axis scale is set.



- Relative.....Regardless of brightness of light source, the peak of brightness in each measurement and memorized values is regarded as 1.0 to compare the light sources in shape of spectrum graph.
- AutoThe appropriate Y-axis value is automatically selected and spectral irradiance can be compared.
- Spectral IrradianceSpecific value can be selected from 1.0u to 100 W·m⁻²·nm⁻¹.

Relative

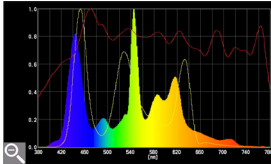

Auto

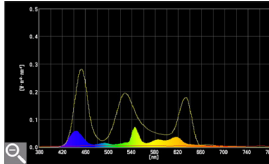

Spectral Irradiance

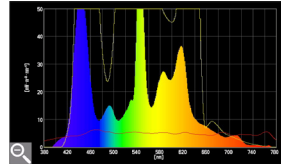

7-2-4

Selecting the Auto Power Off Time

Select the time delay before the power automatically turns off after last use (5min, 10min, 20min, No Auto Power Off). When No Auto Power Off is set, the automatic power OFF function is not activated.

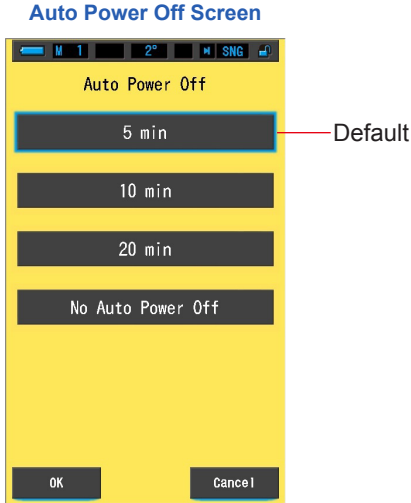

Operation

1. Touch the item [Auto Power Off] button on page 1 of Setting screen.

The auto power off time will be displayed.

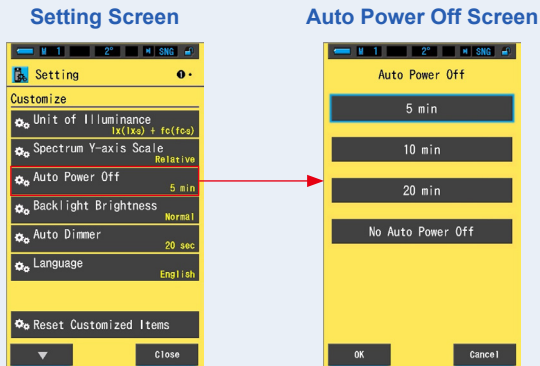

2. Touch the desired time delay button on the Auto Power Off screen.

Select 5min, 10min, 20min, or No Auto Power Off.

Auto Power Off Screen

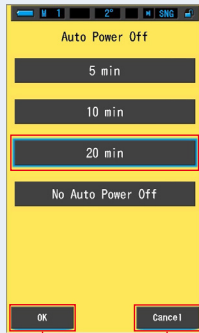

The selected button will be displayed encircled in blue.

[OK] Button

[Cancel] Button

3. Touch the [OK] button.

Confirms the settings, and returns to Setting screen.

To return to the Setting screen without confirming, touch the [Cancel] button.

Setting Screen

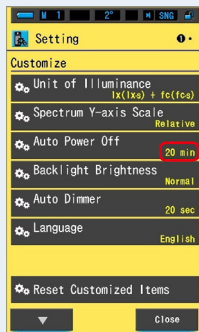

The set content is displayed.

The auto power off time delay is set.

7-2-5

Selecting the Backlight Brightness

Select the LCD backlight brightness from Dark, Normal or Bright to save extra power or adjust the visibility under the surrounding light condition.

Backlight Brightness Screen

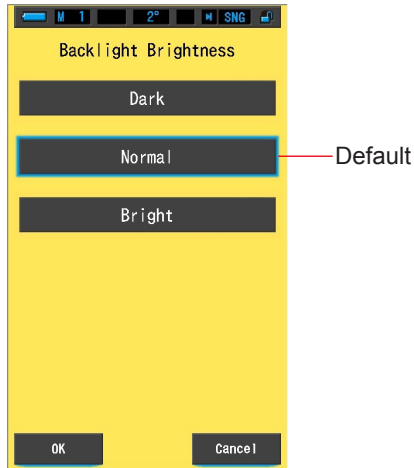

Operation

1. Touch the item [Backlight Brightness] button on page 1 of Setting screen.

The Backlight Brightness screen will be displayed.

Setting Screen

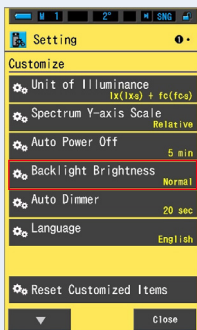

Backlight Brightness Screen

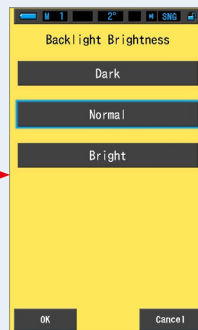

2. Touch the desired brightness button on the Backlight Brightness screen.

Select Dark, Normal or Bright.

Backlight Brightness Screen

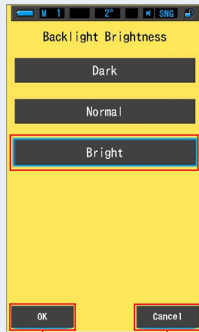

The selected button will be displayed encircled in blue.

[OK] Button

[Cancel] Button

3. Touch the [OK] button.

Confirms the settings, and returns to Setting screen.

To return to the Setting screen without confirming, touch the [Cancel] button.

Setting Screen

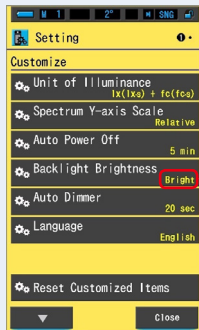

The set content is displayed.

The backlight brightness is set.

7-2-6

Selecting the Auto Dimmer Time

Select the time before the backlight dims after last use to save extra power.
(5sec, 10sec, 20sec, 40sec, 60sec, No Dimmer)

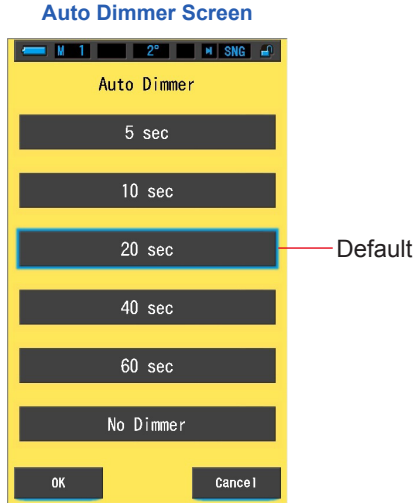

Operation

1. Touch the [Auto Dimmer] button on page 1 of Setting screen
The auto dimmer time delays will be displayed.

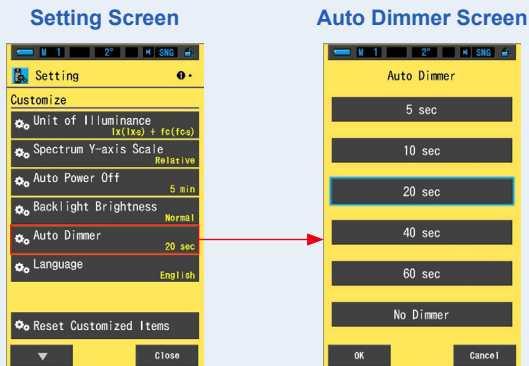

2. Touch the desired time delay button on the Auto Dimmer screen.

Select 5sec, 10sec, 20sec, 40sec, 60sec, or No Dimmer.

Auto Dimmer Screen

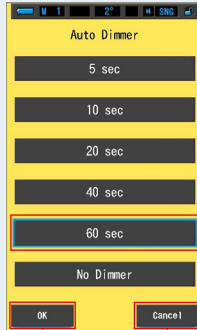

The selected button will be displayed encircled in blue.

[OK] Button [Cancel] Button

3. Touch the [OK] button.

Confirms the settings, and returns to Setting screen.

To return to the Setting screen without confirming, touch the [Cancel] button.

Setting Screen

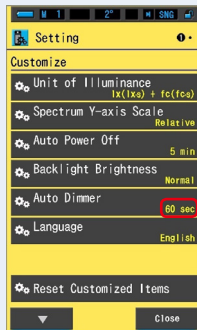

The set content is displayed.

The auto dimmer time is set.

7-2-7

Selecting the Language

Select the language displayed in the meter from English, Japanese or Chinese.



Operation

1. Touch the [Language] button on page 1 of Setting screen
The language will be displayed.

* You can change the language set when power is turned on for the first time.

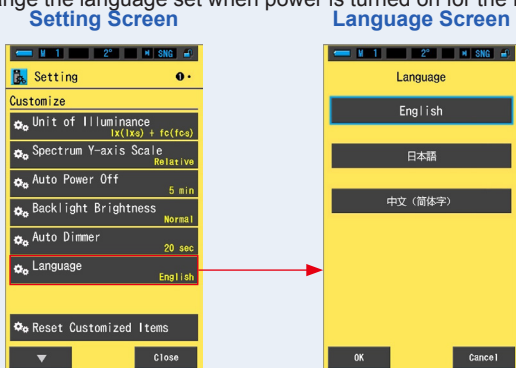

2. Touch the desired language to use.

Select English, Japanese or Chinese.

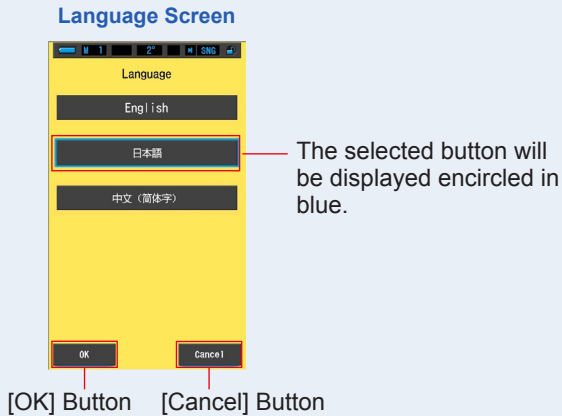

3. Touch the [OK] button.

Confirms the settings, and returns to Setting screen.

To return to the Setting screen without confirming, touch the [Cancel] button.



The language is set.

7-2-8 Reset Customized Items

Initialize (reset) only contents of “Customize” in Setting to the factory default.

Reset Customized Items Screen

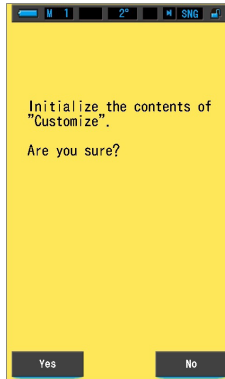

Operation

1. Touch the item [Reset Customized Items] button on page 1 of Setting screen.

"Initialize the contents of "Customize". Are you sure?" is displayed.

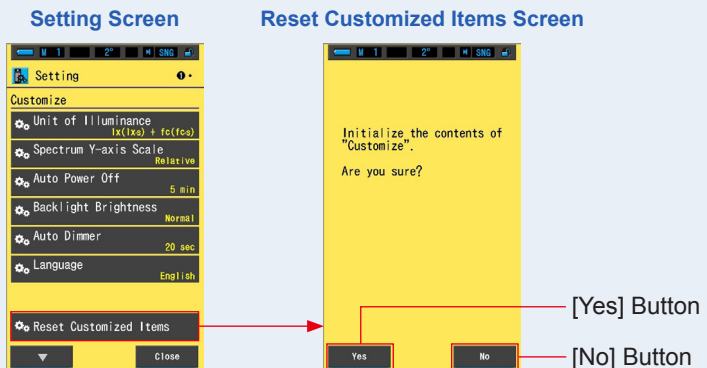

2. Touch the [Yes] button.

Custom settings are reset. After finishing initialization, returns to Setting screen.

To return to the Setting screen without initializing, touch the [No] button.

7-3 Preset Editing

Select [Preset Editing (2°)] button or [Preset Editing (10°)] button.

Preset value is used for the reference value in Monitor Function.

This preset reference value can be input manually or set from memorized value if there is data in meter's memory.

Refer to page 199 for details on Field of View (2 degrees and 10 degrees).

Preset Editing Screen
(Page 1)

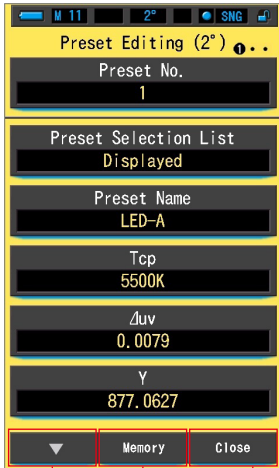

To page 2

[Memory] Button

Preset Editing Screen
(Page 2)

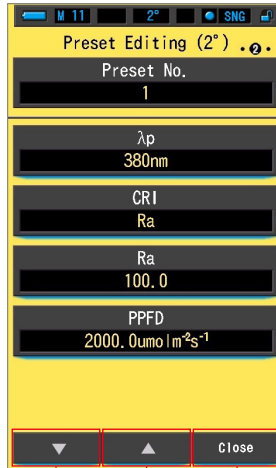

To page 3

To page 1

[Close] Button

Preset Editing Screen
(Page 3)

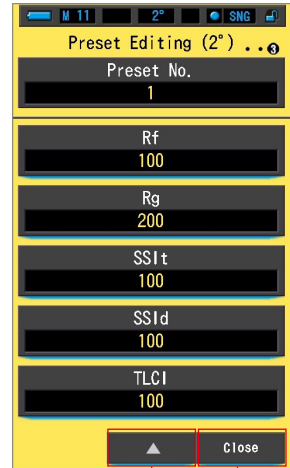

To page 2

* If no value is stored in memory, the [Memory] button is not activated.



NOTE

- Up to 5 presets can be registered for each of viewing angle 2° and 10°.

Operation

1. Touch the item [Preset Editing (2°)] or [Preset Editing (10°)] button on page 2 of Setting screen.

The Preset Editing screen of Setting will be displayed.

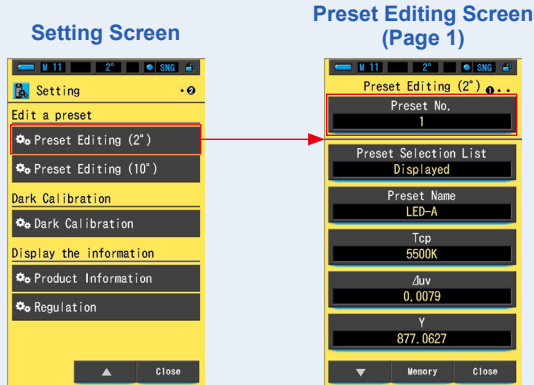

2. Touch the [Preset No.] button on page 1 of [Preset Editing (2°)] or [Preset Editing (10°)].

The Preset Number screen is displayed.

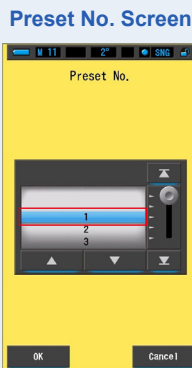

3. Select the desired present number (1 ~ 5) to edit. Adjust it to the blue background position.

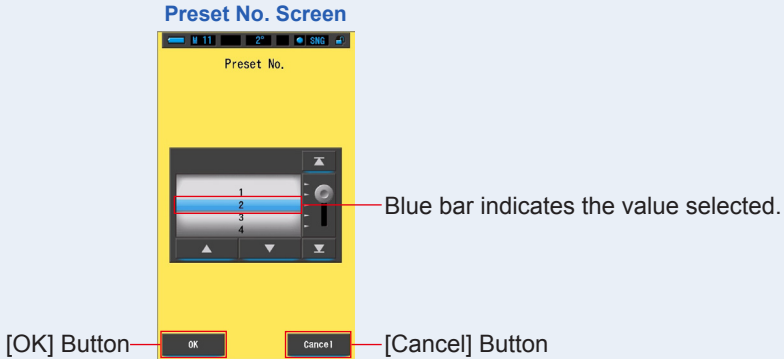

4. Touch the [OK] button.

Preset number is confirmed and the display returns to page 1 of the Preset Editing (2°)/(10°) screen.

To return to the page 1 of the Preset Editing (2°)/(10°) screen without confirming, touch the [Cancel] button.

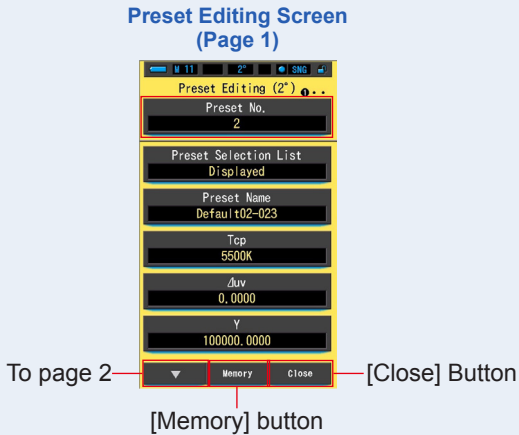

[Setting the preset value from memorized value]

1. Touch the [Memory] button on the page 1 of Preset Editing screen.

Memory Recall screen is displayed.

Preset Editing Screen
(Page 1)

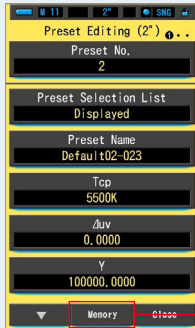

[Memory] button

Memory Recall Screen
in Preset Editing



The selected memory will be displayed encircled in blue.

[OK] button

[Cancel] button

2. Select the memorized value to set.

The selected memory will be displayed encircled in blue.

Memory Recall Screen in Preset Editing

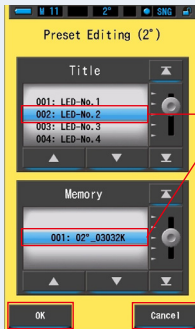

The selected memory will be displayed encircled in blue.

[OK] button

[Cancel] button

3. Touch the [OK] button.

The selected memory is set as preset information and the display returns to page 1 of the Preset Editing (2°)/(10°).

To return to the page 1 of the Preset Editing (2°)/(10°) screen without confirming, touch the [Cancel] button.

Preset Editing Screen (Page 1)



To page 2 — [Close] button

4. Touch the [Close] button.

Returns to Setting screen.

[Setting the preset value manually]

1. Edit each setting item.

Touch each item to edit the setting value.

Preset Editing Screen (Page 1)

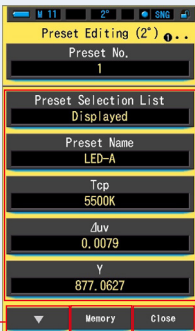

To page 2 [Memory] Button [Close] Button

Preset Editing Screen (Page 2)

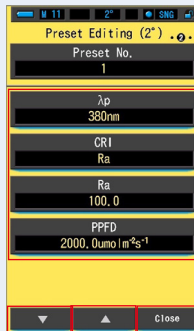

To page 3 [Close] Button
To page 1

Preset Editing Screen (Page 3)

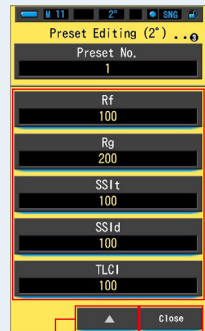

To page 2 [Close] Button

Refer to the following pages for editing each setting item.

- Preset Selection List (➔ P158)
- T_{cp} (Correlated Color temperature) (➔ P162)
- Y (tristimulus value) (➔ P166)
- CRI (Color Rendering Index) (➔ P170)
- PPF_D (Photosynthetic Photon Flux Density) (➔ P174)
- R_f (Fidelity Index) (➔ P176)
- SS_{It} (SSI Tungsten) (➔ P180)
- TL_{CI} (Television Lighting Consistency Index) (➔ P184)
- Preset Name (➔ P160)
- Δ_{uv} (deviation) (➔ P164)
- λ_p (peak wavelength) (➔ P168)
- R_a (Average CRI) (➔ P172)
- R_g (Gamut Index) (➔ P178)
- SS_{Id} (SSI Daylight) (➔ P182)

2. Touch the [Close] button.

Returns to Setting screen.

7-3-1

Displaying the Preset Selection List

Select to display or not in the Preset Selection list in the Tool Box.

Display in the Preset Selection List Screen

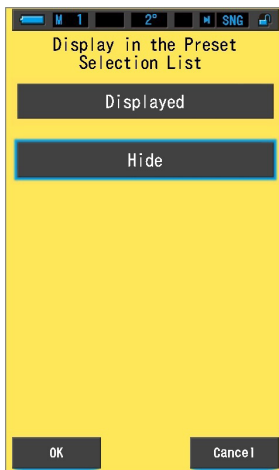

Operation

1. Touch the [Preset Selection List] button on page 1 of Preset Editing (2°) or Preset Editing (10°).

Display in the Preset Selection List will appear.

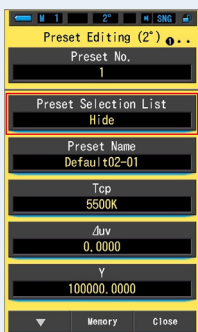
Preset Editing Screen
(Page 1)

Display in the Preset Selection List Screen

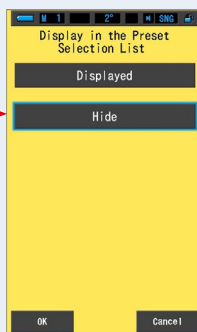

2. Select the [Displayed] to set.

The selected icon will be displayed encircled in blue.

Display in the Preset Selection List Screen

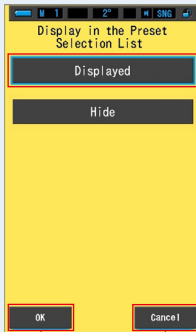

The selected button will be displayed encircled in blue.

[OK] Button [Cancel] Button

3. Touch the [OK] button.

The set item is confirmed, and the display returns to page 1 of the Preset Editing (2°)/(10°) screen.

To return to the page 1 of the Preset Editing (2°)/(10°) screen without confirming, touch the [Cancel] button.

Preset Editing Screen (Page 1)

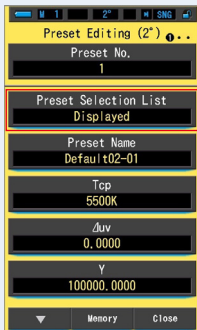

The Preset Selection List is set.

7-3-2 Setting the Present Name

Editing the Preset Name.



NOTE

- Up to 16 alphanumeric characters can be input for Preset name.

Operation

1. Touch the [Preset Name] button on page 1 of Preset Editing (2°) or Preset Editing (10°).

The Preset Name Input screen is displayed.

**Preset Editing Screen
(Page 1)**

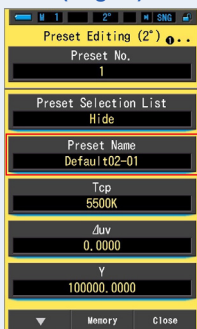

Preset Name Screen

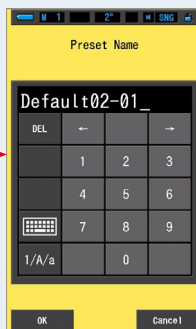

2. Use the keyboard to create a name for the preset. (→ P18)

Preset Name Screen



Input number

Keypad (Upper Case Input Screen)



[OK] Button [Cancel] Button

3. Touch the [OK] button.

The Preset name is memorized, and the display returns to the page 1 of the Preset Editing (2°)/(10°) screen.

To return to the page 1 of the Preset Editing (2°)/(10°) screen without confirming (memorizing/editing), touch the [Cancel] button.

Page 1 Screen (with memory)

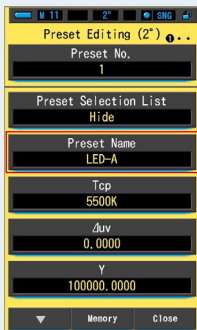

The preset name is entered and memorized.

7-3-3 Setting the Tcp

Set the preset Tcp (Correlated Color Temperature).

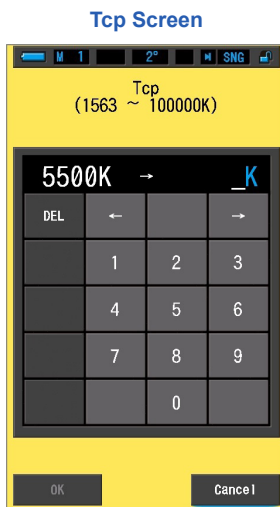

Operation

1. Touch the [Tcp] button on page 1 of Preset Editing (2°) or Preset Editing (10°).

The Tcp Input screen will be displayed.

Preset Editing Screen (Page 1)

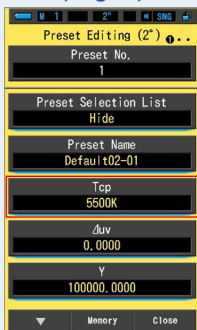

Tcp Screen

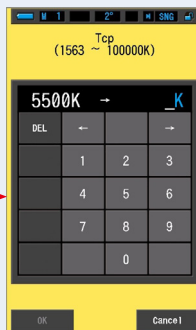

2. Set the Tcp within the range from 1563 to 100000K. (⇒ P18)

If the entered value is within the setting range, the [OK] button is displayed.

If it is outside the set range, re-entred a value.

Tcp Screen
(if within the set range)

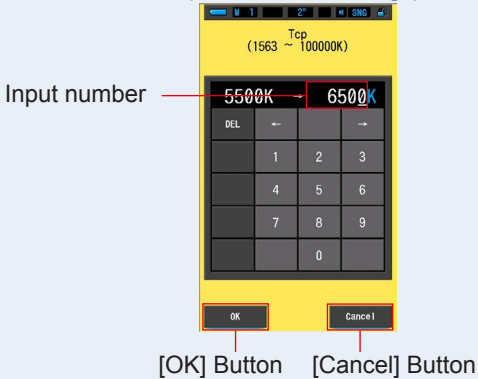

Tcp Screen
(if outside the set range)

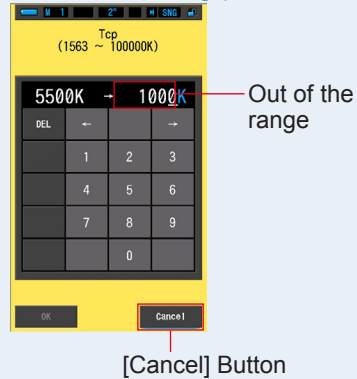

3. Touch the [OK] button.

The number is fixed, and the display returns to the page 1 of the Preset Editing (2°)/(10°) screen.

To return to the page 1 of the Preset Editing (2°)/(10°) screen without confirming, touch the [Cancel] button.

Page 1 Screen
(with memory)

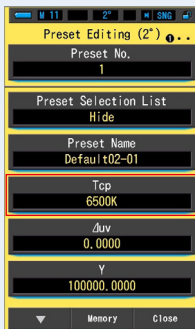

The Tcp (Correlated Color Temperature) is edited.

7-3-4 Setting the Δuv

Sets the preset Δuv (Deviation).

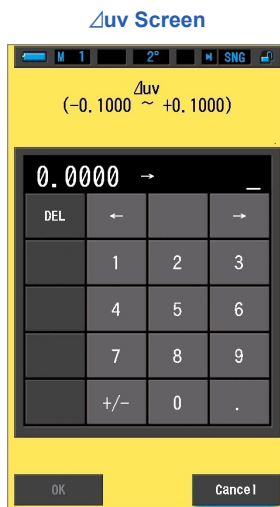

Operation

1. Touch the [Δuv] button on page 1 of Preset Editing (2°) or Preset Editing (10°).

The Δuv input screen will be displayed.

Preset Editing Screen (Page 1)

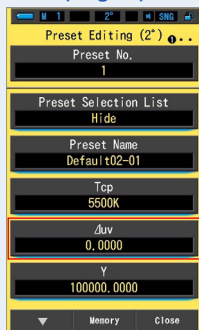

Δuv Screen

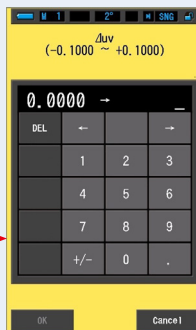

2. Set the Δuv deviation value from -0.1000 to +0.1000. (⇒ P18)

If the entered value is within the setting range, the [OK] button is displayed.

If it is outside the set range, re-entered a value.

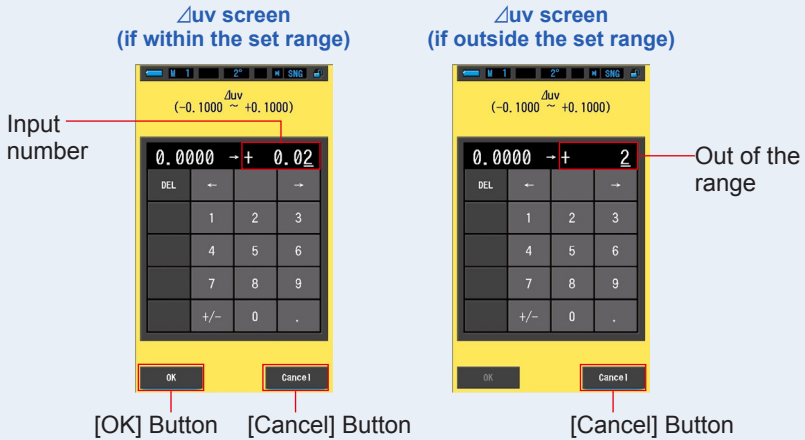

3. Touch the [OK] button.

The number is memorized, and the display returns to the page 1 of the Preset Editing (2°)/(10°) screen.

To return to the page 1 of the Preset Editing (2°)/(10°) screen without confirming, touch the [Cancel] button.

Preset Editing Screen (Page 1)

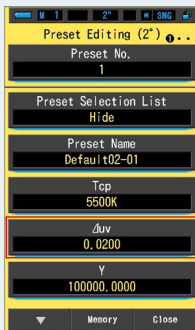

The Δuv (Deviation) is edited.

7-3-5

Setting the Tristimulus Value Y

The preset tristimulus value Y can be set as illuminance (lx).

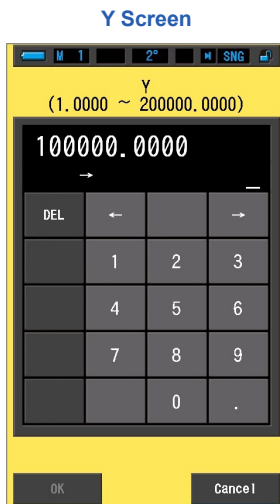
**Operation**

1. Touch the [Y] button on page 1 of Preset Editing (2°) or Preset Editing (10°).

The tristimulus value Y input screen is displayed.

**Preset Editing Screen
(Page 1)**

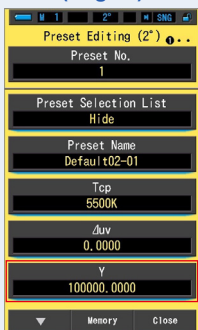

Y Screen



2. Set the tristimulus value Y from 1.0000 to 200000.0000. (⇒ P18)

If the entered value is within the setting range, the [OK] button is displayed.

If it is outside the setting range, re-enter a value.

Y Screen
(within the setting range)

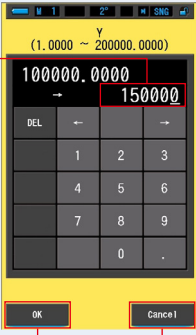

Input number →

[OK] Button [Cancel] Button

Y Screen
(outside the setting range)

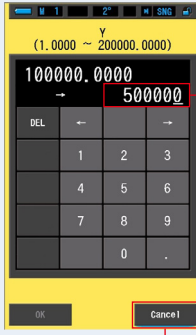

→ Outside the range

[Cancel] Button

3. Touch the [OK] button.

The number is confirmed and the display returns to the page 1 of the Preset Editing (2°)/(10°) screen.

To return to page 1 of the Preset Editing (2°)/(10°) screen without confirming, touch the [Cancel] button.

Preset Editing Screen (Page 1)

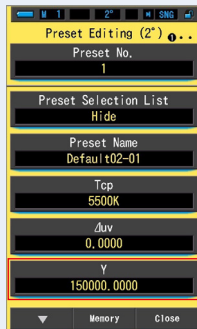

The tristimulus value Y (illuminance (Ix)) is edited.



NOTE

- The edited preset data will be displayed on the Preset Information screen.
- Setting range of tristimulus value Y is 1.0000 to 200,000, although the meter's measuring range of illuminance (Ix) is from 1 to 200,000Ix.

7-3-6 Setting the λ_p

Setting the preset peak wavelength λ_p (Peak wavelength).

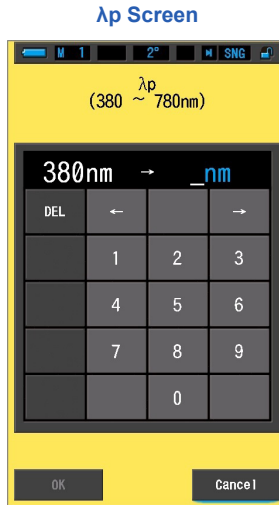

Operation

1. Touch the [λ_p] button on page 2 of Preset Editing (2°) or Preset Editing (10°).

The peak wavelength λ_p input screen is displayed.

Preset Editing Screen (Page 2)

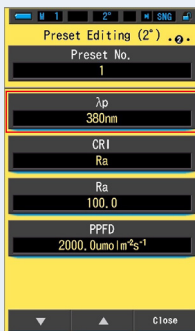

λ_p Screen

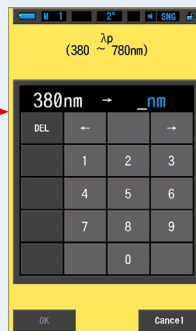

- 2. Set the peak wavelength λ_p within the range from 380 to 780 nm. (⇒ P18)**
 If the entered value is within the setting range, the [OK] button is displayed.
 If it is outside the setting range, re-enter a value.

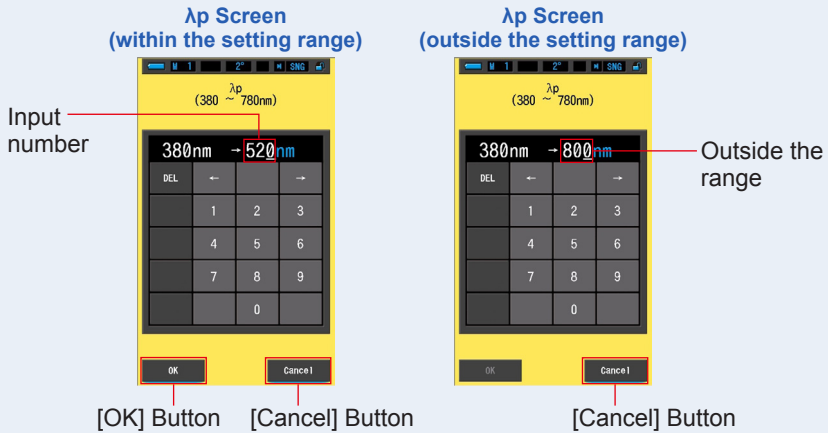

- 3. Touch the [OK] button.**

The number is memorized, and the display returns to the page 2 of the Preset Editing (2°)/(10°) screen.

To return to the page 2 of the Preset Editing (2°)/(10°) screen without confirming, touch the [Cancel] button.

Preset Editing Screen (Page 2)

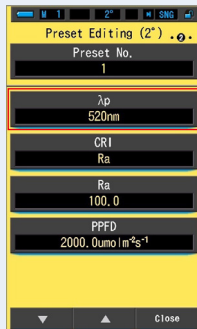

The λ_p (Peak wavelength) is edited.

7-3-7 Setting the CRI

Select the preset CRI (Color Rendering Index: Ra, or R1 to R15).

CRI Selection Screen

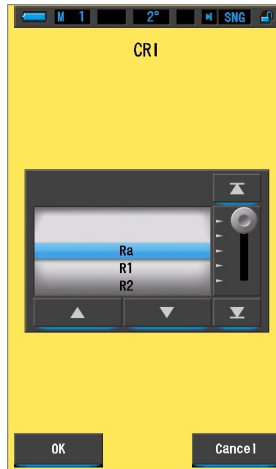

Operation

1. Touch the [CRI] button on page 2 of Preset Editing (2°) or Preset Editing (10°).

The Color Rendering Index screen is displayed.

Preset Editing Screen (Page 2)

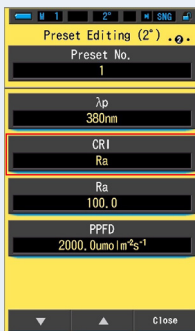

CRI Selection Screen

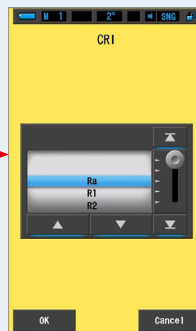

2. Select the desired color rendering index. (⇒ P18)

Select Ra, or any single index from R1 to R15. Adjust the index under the blue background to select.

CRI Selection Screen

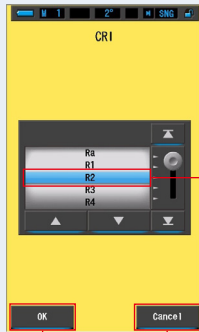

The selected CRI will be displayed encircled in blue.

[OK] Button [Cancel] Button

3. Touch the [OK] button.

The set item is memorized, and the display returns to the page 2 of the Preset Editing (2°)/(10°) screen.

To return to the page 2 of the Preset Editing (2°)/(10°) screen without confirming, touch the [Cancel] button.

Preset Editing Screen (Page 2)

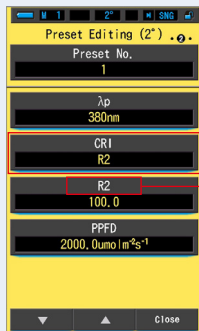

Color Rendering Index

This setting also appears the selected index on the CRI screen.

The CRI (Color Rendering Index) is edited.

7-3-8 Setting the value of CRI

Set the preset CRI value for the selected CRI. (➔ P170)

Selected CRI Value Input Screen

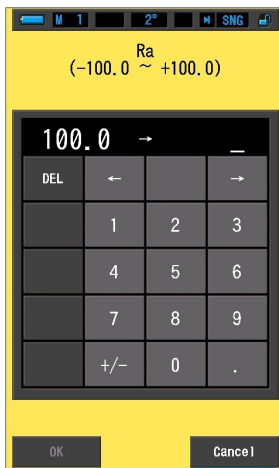

Operation

1. Touch the [Selected CRI Value Input] button on page 2 of Preset Editing (2°) or Preset Editing (10°).

The Selected CRI Value input screen is displayed. (The default is Ra.)

Preset Editing Screen
(Page 2)



Selected CRI Value Input
Screen

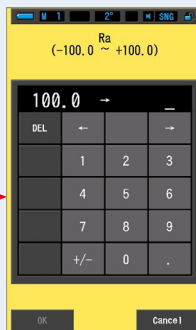

2. Set the value of selected CRI from 0 to 100. (⇒ P18)

If the entered value is within the setting range, the [OK] button is displayed.

If it is outside the setting range, re-enter a value.

Selected CRI Value Input Screen
(within the setting range)

Selected CRI Value Input Screen
(outside the setting range)

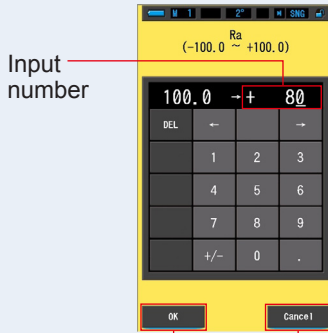

Input number

[OK] Button

[Cancel] Button



Outside the range

[Cancel] Button

3. Touch the [OK] button.

The number is memorized, and the display returns to the page 2 of the Preset Editing (2°)/(10°) screen.

To return to the page 2 of the Preset Editing (2°)/(10°) screen without confirming, touch the [Cancel] button.

Preset Editing Screen
(Page 2)

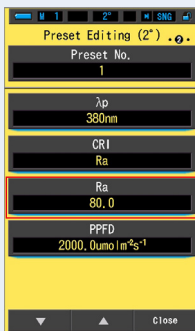

The selected CRI value is edited.

7-3-9

Setting the PPF

Setting the PPF (Photosynthetic Photon Flux Density).

PPFD Screen



Operation

1. Touch the [PPFD] button on page 2 of Preset Editing (2°) or Preset Editing (10°).

The PPF input screen is displayed.

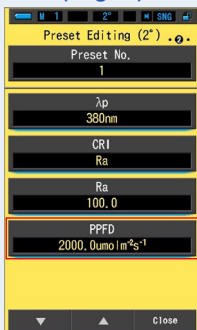
Preset Editing Screen
(Page 2)

PPFD Screen

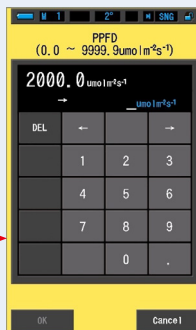

2. Set the PPF from 0.0 to 9999.9 $\mu\text{mol m}^{-2}\text{s}^{-1}$. (→ P18)

If the entered value is within the setting range, the [OK] button is displayed.

If it is outside the setting range, re-enter a value.

PPFD Screen
(within the setting range)

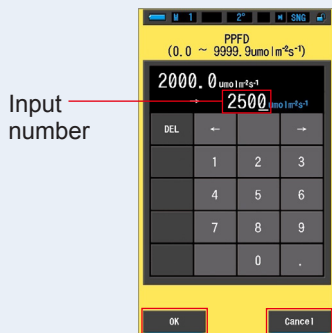

[OK] Button [Cancel] Button

PPFD Screen
(outside the setting range)

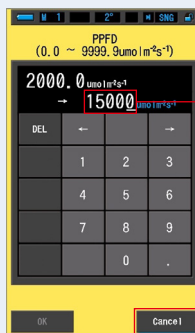

[Cancel] Button

3. Touch the [OK] button.

The number is memorized, and the display returns to the page 2 of the Preset Editing (2°)/(10°) screen.

To return to the page 2 of the Preset Editing (2°)/(10°) screen without confirming, touch the [Cancel] button.

Preset Editing Screen
(Page 2)

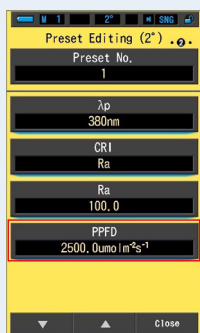

The PPF (Photosynthetic Photon Flux Density) is edited.

7-3-10 Setting the Rf

Setting the Rf (Fidelity Index).



Operation

1. Touch the [Rf] button on page 3 of Preset Editing (2°) or Preset Editing (10°).

The Rf input screen is displayed.

**Preset Editing Screen
(Page 3)**

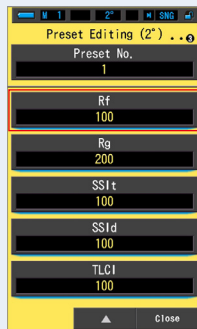

Rf Screen



2. Set the Rf from 0 to 100. (⇒ P18)

If the entered value is within the setting range, the [OK] button is displayed.

If it is outside the setting range, re-enter a value.

Rf Screen
(within the setting range)

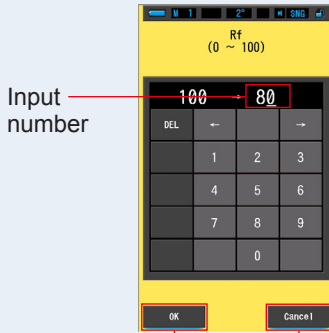

[OK] Button [Cancel] Button

Rf Screen
(outside the setting range)

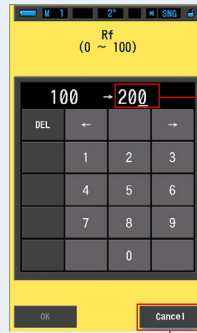

[Cancel] Button

3. Touch the [OK] button.

The number is memorized, and the display returns to the page 3 of the Preset Editing (2°)/(10°) screen.

To return to the page 3 of the Preset Editing (2°)/(10°) screen without confirming, touch the [Cancel] button.

Preset Editing Screen
(Page 3)

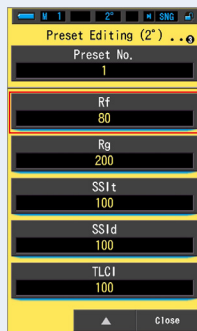

The Rf (Fidelity Index) is edited.

7-3-11 Setting the Rg

Setting the Rg (Gamut Index).



Operation

1. Touch the [Rg] button on page 3 of Preset Editing (2°) or Preset Editing (10°).

The Rg input screen is displayed.

**Preset Editing Screen
(Page 3)**

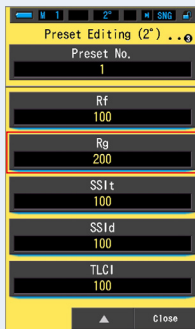

Rg Screen



2. Set the Rg from 0 to 200. (⇒ P18)

If the entered value is within the setting range, the [OK] button is displayed.

If it is outside the setting range, re-enter a value.

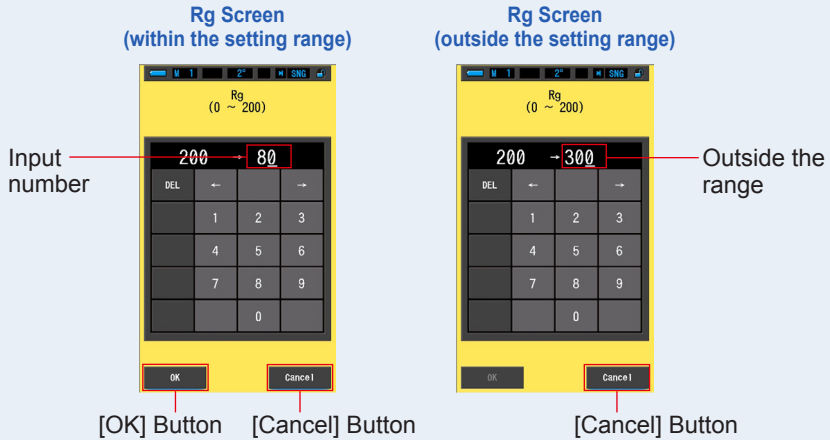

3. Touch the [OK] button.

The number is memorized, and the display returns to the page 3 of the Preset Editing (2°)/(10°) screen.

To return to the page 3 of the Preset Editing (2°)/(10°) screen without confirming, touch the [Cancel] button.

Preset Editing Screen (Page 3)

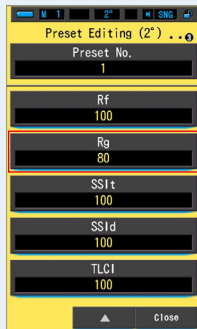

The Rg (Gamut Index) is edited.

7-3-12 Setting the SSIt

Setting the SSIt (SSI Tungsten).



Operation

1. Touch the [SSIt] button on page 3 of Preset Editing (2°) or Preset Editing (10°).

The SSIt input screen is displayed.

**Preset Editing Screen
(Page 3)**

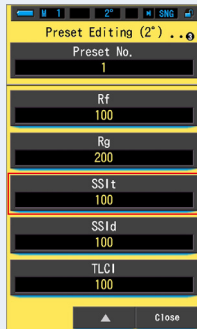

SSIt Screen



2. Set the SSIt from 0 to 100. (⇒ P18)

If the entered value is within the setting range, the [OK] button is displayed.

If it is outside the setting range, re-enter a value.

SSIt Screen
(within the setting range)

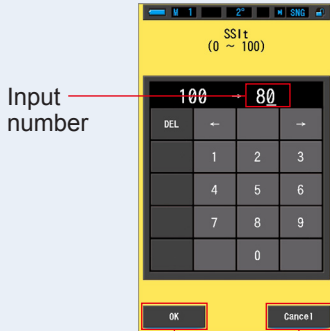

Input number

[OK] Button

[Cancel] Button

SSIt Screen
(outside the setting range)



Outside the range

[Cancel] Button

3. Touch the [OK] button.

The number is memorized, and the display returns to the page 3 of the Preset Editing (2°)/(10°) screen.

To return to the page 3 of the Preset Editing (2°)/(10°) screen without confirming, touch the [Cancel] button.

Preset Editing Screen
(Page 3)

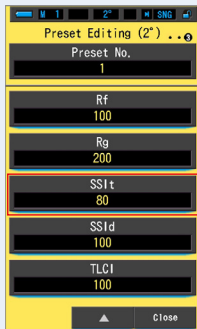

The SSIt (SSI Tungsten) is edited.

7-3-13 Setting the SSId

Setting the SSId (SSI Daylight).

SSId Screen

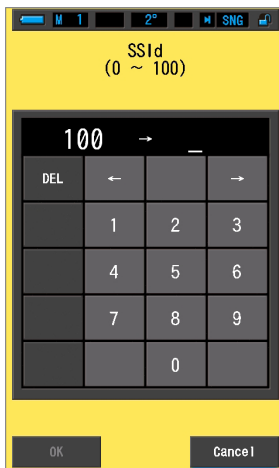

Operation

1. Touch the [SSId] button on page 3 of Preset Editing (2°) or Preset Editing (10°).

The SSId input screen is displayed.

Preset Editing Screen
(Page 3)

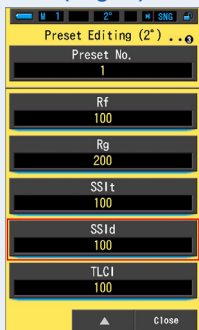

SSId Screen

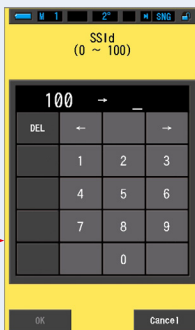

2. Set the SSId from 0 to 100. (⇒ P18)

If the entered value is within the setting range, the [OK] button is displayed.

If it is outside the setting range, re-enter a value.

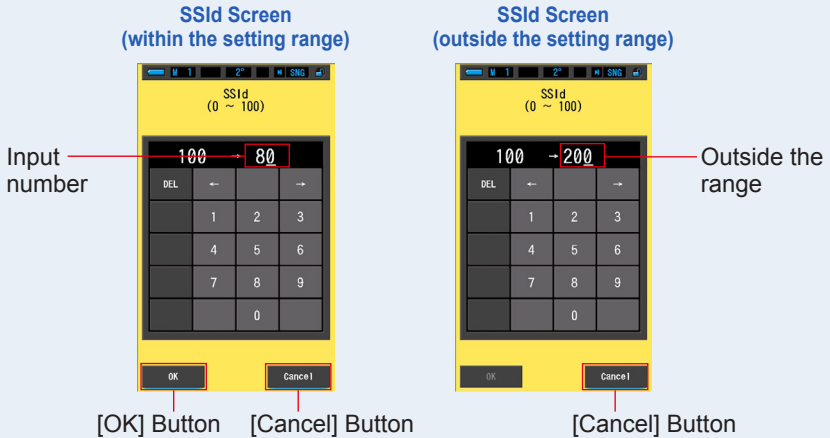

3. Touch the [OK] button.

The number is memorized, and the display returns to the page 3 of the Preset Editing (2°)/(10°) screen.

To return to the page 3 of the Preset Editing (2°)/(10°) screen without confirming, touch the [Cancel] button.

Preset Editing Screen (Page 3)

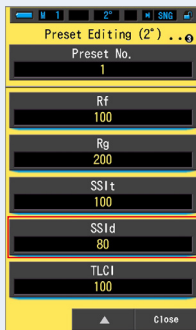

The SSId (SSI Daylight) is edited.

7-3-14 Setting the TLCI

Setting the TLCI (Television Lighting Consistency Index).

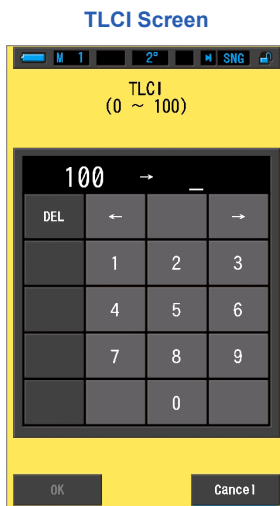

Operation

1. Touch the [TLCI] button on page 3 of Preset Editing (2°) or Preset Editing (10°).

The TLCI input screen is displayed.

**Preset Editing Screen
(Page 3)**

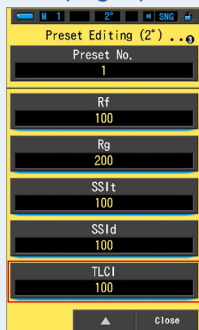

TLCI Screen

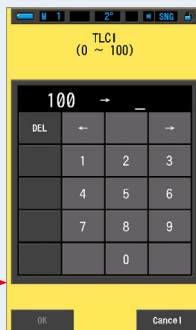

2. Set the TLCI from 0 to 100. (→ P18)

If the entered value is within the setting range, the [OK] button is displayed.

If it is outside the setting range, re-enter a value.

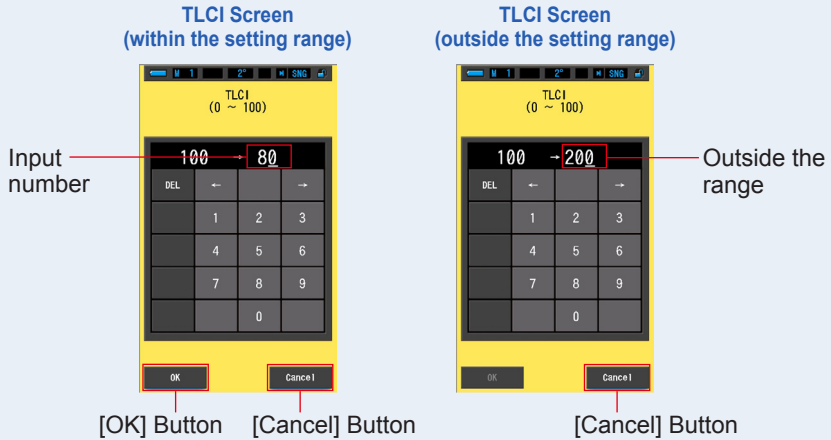

3. Touch the [OK] button.

The number is memorized, and the display returns to the page 3 of the Preset Editing (2°)/(10°) screen.

To return to the page 3 of the Preset Editing (2°)/(10°) screen without confirming, touch the [Cancel] button.

Preset Editing Screen (Page 3)

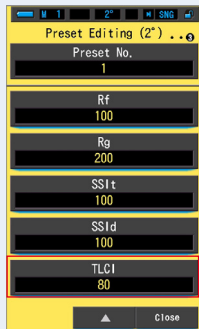

The TLCI (Television Lighting Consistency Index) is edited.



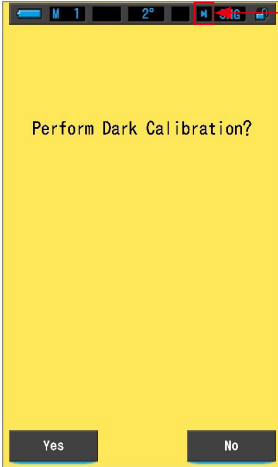

7-4 Dark Calibration

Dark calibration is performed when new batteries are used, 24 hours passed since last use or there is a big change in temperature between turning power OFF and ON again. Except the cases above, dark calibration after power ON is skipped. Accordingly, when there are sudden changes in temperature experienced while using the meter, the meter may effect measured values. When temperature changes are encountered, perform dark calibration manually.

Dark Calibration Confirmation Screen



Light Selection Ring Status Indicator Chart

Icon		Content
		If either of icons appears, set the Light Selection Ring ② to the dark calibration position.
		
	CAL	This icon is the dark calibration position. Perform dark calibration after making sure it is set to this position.

Operation

1. Touch the item [Dark Calibration] button on page 2 of Setting.
"Perform Dark Calibration?" will be displayed.

Setting Screen



Dark Calibration Confirmation Screen

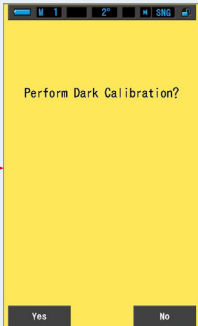

2. Turn the Light Selection Ring ② to set to the dark calibration position CAL ().

The status bar will display the dark calibration icon.

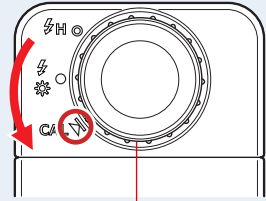
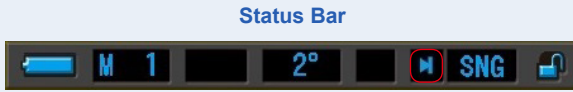

Light Selection Ring ②

3. Touch the [Yes] button.

"Dark calibration in progress. Please wait" and the status bar will appear while meter's measuring system is being calibrated.

To return to Setting without performing dark calibration, touch the [No] button.

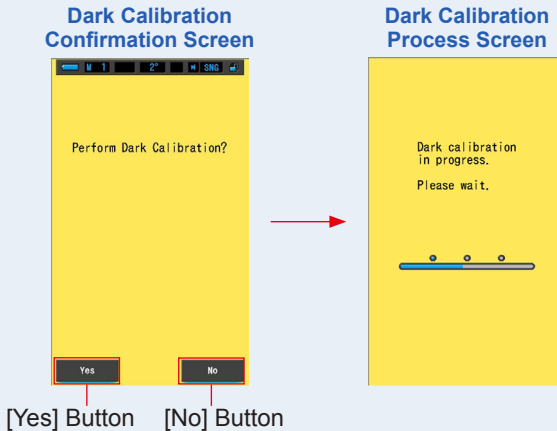

NOTICE

- While the message "Dark calibration in progress. Please wait." or the progress bar is displayed, do not turn the power off. Otherwise, the meter may be damaged.

The dark calibration is completed.

When the Following Screen is Displayed

Dark Calibration Position Confirmation Screen



If the Light Selection Ring ② is set to Range H (⚡ H) or Range L (⚡ L), dark calibration cannot be performed.

Set the Light Selection Ring ② to the dark calibration position **CAL** (▶), and perform dark calibration.

Dark Calibration Failure Screen

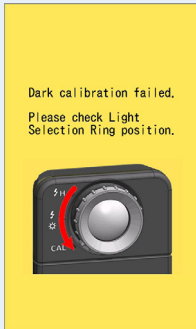

If Dark calibration was performed, but it could not be completed normally.

Set the Light Selection Ring ② to the dark calibration position **CAL** (▶) again, and perform dark calibration again.

NOTE

- Dark calibration can be done by turning the Light Selection Ring ② to set to the dark calibration position **CAL** (▶) in Measuring.
- Dark calibration is performed when new batteries are set, 24 hours passed since last use or there is a big change in temperature between turning power OFF and ON again. Except the cases above, dark calibration after power ON is skipped.

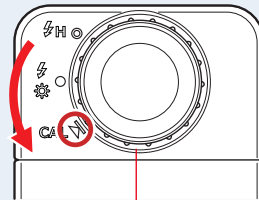

Light Selection Ring ②

7-5 Product Information Display

The Product Information screen displays detailed information not displayed in the Measuring screen.

Product Information Screen

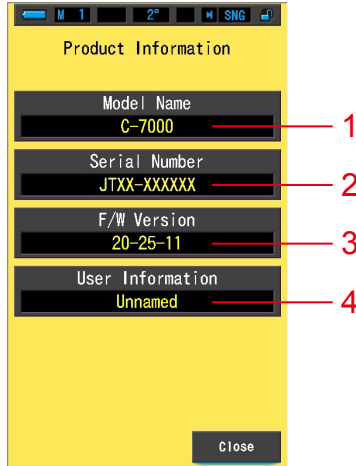

* The screen contents differs depending on model.

No.	Item Name	Description
1	Model Name	Displays the model number of the meter.
2	Serial Number	Displays the serial number of the meter.
3	F/W Version	Displays the firmware version.
4	User Information	Displays user-input information such as ownership or meter function, etc which is set in the "Hardware Setting". (➡ P192)

Operation

1. Touch the item [Product Information] button on page 2 of Setting.
The Product Information screen will be displayed.

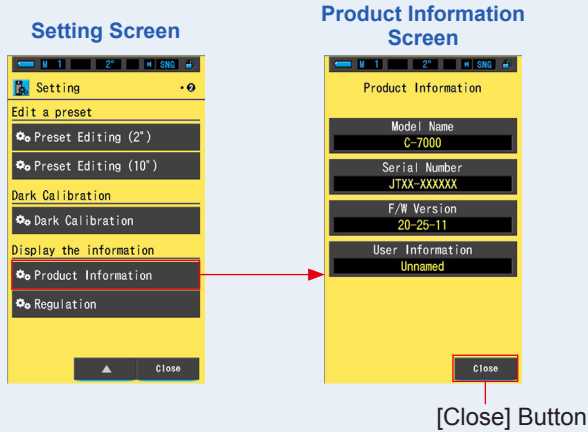

2. Touch the [Close] button.
Returns to the Setting screen.

7-6 Regulation Display

The Regulation screen displays the symbols, approved number, regulation names, etc. which the meter is compliance with.

Regulation Screen

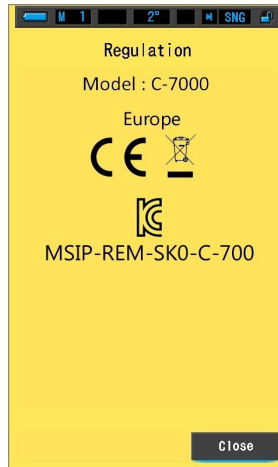

Operation

1. Touch the item [Regulation] button on page 2 of Setting.

The Regulation screen will be displayed.

The display contents will differ depending on the product you have purchased.

Setting Screen

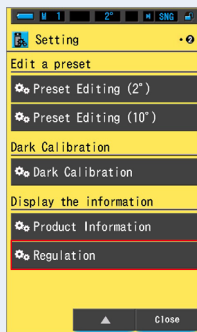

Regulation Screen

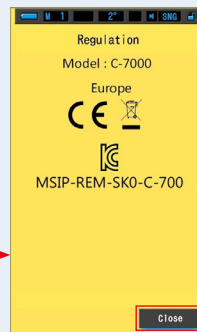

[Close] Button

2. Touch the [Close] button.

Returns to the Setting screen.

8. Hardware Setting Screen

The following items can be set on the Hardware Setting screen.

- Adjust Touch Panel
- Edit User Information
- Field of view
- Factory Setting

Hardware Setting Screen

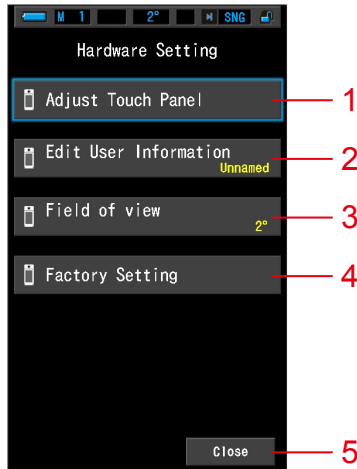

No.	Item Name	Description
1	Adjust Touch Panel	Adjust the positioning of touch panel display. (➔ P194)
2	Edit User Information	Edit user-input information which will be displayed on User Information position of the Product Information screen under the Settings function. (➔ P197)
3	Field of view	Select viewing angle 2° or 10°. (➔ P199)
4	Factory Setting	Returns all display and setting contents to the factory default. (➔ P201)
5	Close	Closes the Hardware Setting screen and returns to Display Mode Selection screen.

Operation

1. With the meter turned OFF, hold down the Menu Button ⑥ and press the Power Button ③.

* Until the Hardware Setting screen is displayed, do not release the Menu Button ⑥ and the Power Button ③.

If the buttons are released before the Hardware Setting screen is displayed, the Measuring screen will be displayed.

The Hardware Setting screen will be displayed.

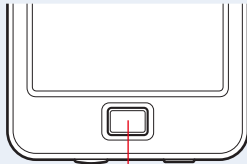

Menu Button ⑥

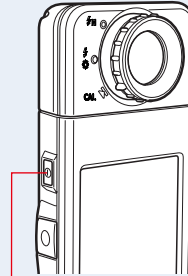

Power Button ③

2. Touch the desired menu item.

The setting screen of the selected item will be displayed.

Refer to the explanations on the following page for each item setting.

3. When completed, touch the [Close] button.

This will return the display to the Display Mode Selection screen.

8-1 Adjust Touch Panel

Adjust the position of touch panel display.

Adjust Touch Panel Screen

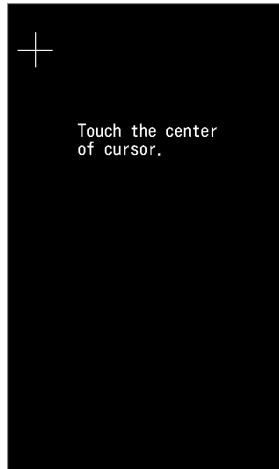

Operation

1. Touch the [Adjust Touch Panel] button on the Hardware Setting screen.

"Touch the center of cursor." will be displayed.

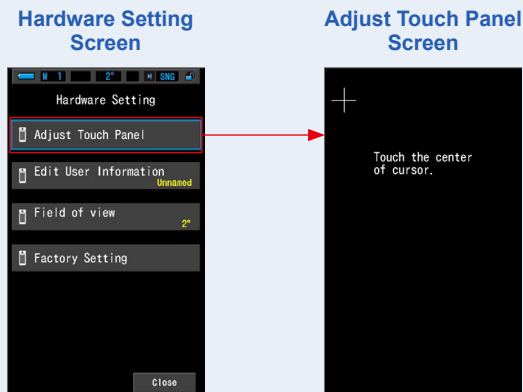

2. Touch the center of the white cross in the upper left corner of the screen.

The touch position will be shown as a coinciding red cross cursor, and the white cross cursor will appear at the next position.

Adjust Touch Panel Screen

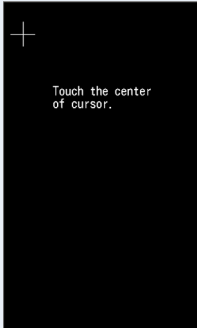

The touch position is showed with a red cross cursor

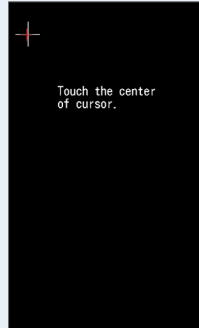

The white cross appears at the next position

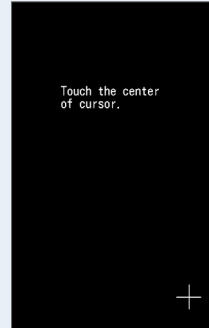

3. Repeat in 7 places.

Continue and repeat in 7 places.

When finished, "Press the "OK" to determine the touch panel adjustment." will be displayed.

Adjust Touch Panel Confirmation Screen

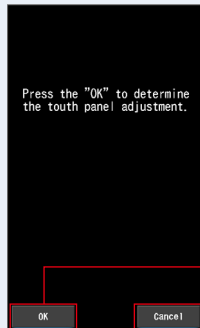

[OK] Button

[Cancel] Button

4. Touch the [OK] button.

Adjustment of touch panel is completed, and the display returns to the Hardware Setting screen.

To return to the Hardware Setting screen without adjusting the setting, touch the [Cancel] button.

Touch panel adjustment is completed.

 **NOTE**

- When a point far from the white cursor is touched, the screen will blink to indicate adjustment failure. Perform the adjustment again.

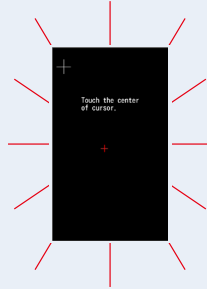
Adjust Touch Panel Screen

8-2 Edit User Information

Edit user information can be entered in this screen.

Edit User Information Screen



NOTE

- Up to 16 alphanumeric characters can be entered.

Operation

1. Touch the [Edit User Information] button on the Hardware Setting screen.

The Edit User Information Input screen is displayed.

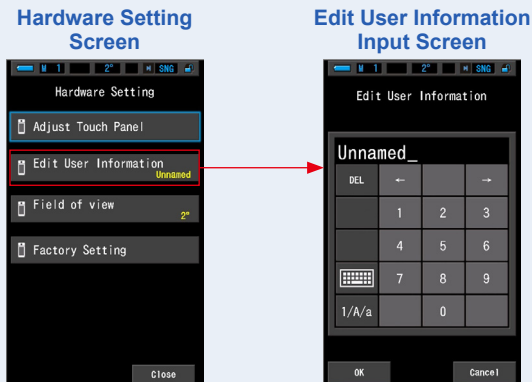

2. Edit the user information. (→ P18)

Edit User Information Input Screen

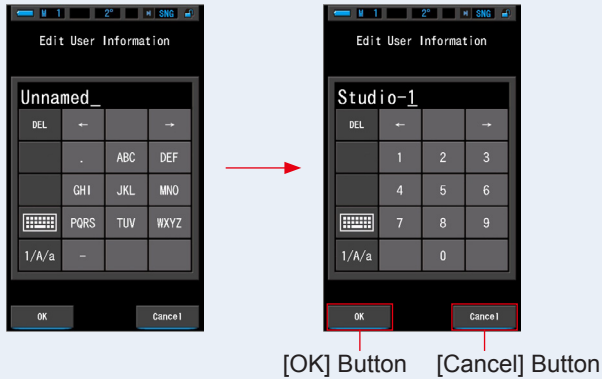

3. Touch the [OK] button.

Registers the user information, and returns to the Hardware Setting screen.

To return to the Hardware Setting screen without registering the user information, touch the [Cancel] button.

Hardware Setting Screen

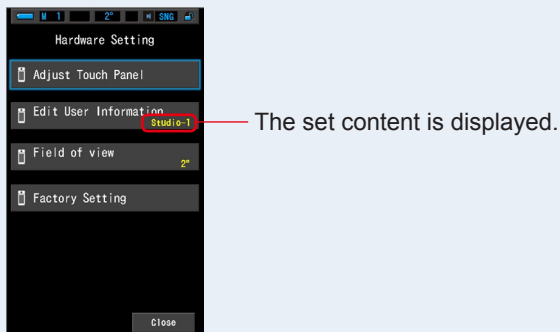

The user information is input.

8-3 Field of View

Set the Field of view for measurement.



Operation

1. Touch the [Field of view] button on the Hardware Setting screen.
The Field of view screen is displayed.

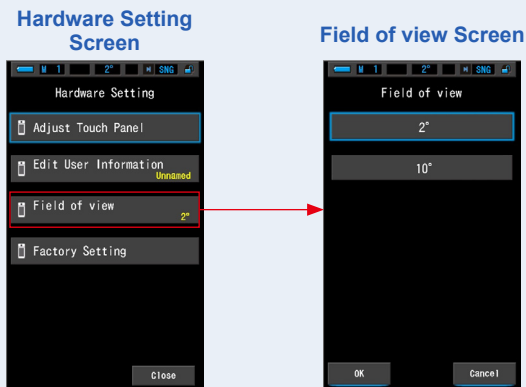

2. Set the Field of view.

Select viewing angle 2° or 10°.

Field of view Screen

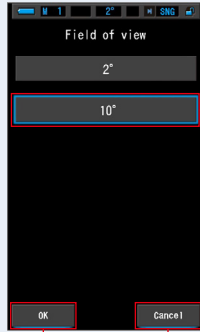

The selected button will be displayed encircled in blue.

[OK] Button [Cancel] Button

3. Touch the [OK] button.

Confirms the settings, and returns to the Hardware Setting screen.

To return to the Hardware Setting screen without confirming, touch the [Cancel] button.

Hardware Setting Screen

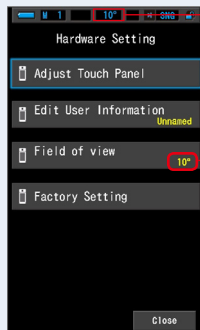

The selected setting is displayed on the status bar.

The set content is displayed.

The Field of view has been set.



NOTE

- CIE standard observers help correlate instrumental color measurements to human visual assessments. The 2 degree field of view is common within quality control and other color evaluation procedures, particularly for food applications. The 10 degree field of view is considered to be more representative of how the human eye is commonly used with spectrophotometers for formulating and evaluating the color of various types of samples.

8-4

Factory Setting

Return all display and setting contents of the meter to the factory default.

Factory Setting Screen



Operation

1. Touch the [Factory Setting] button on the Hardware Setting screen.

The screen of "Reset to factory default settings. Are you sure?" will be displayed.

Hardware Setting Screen

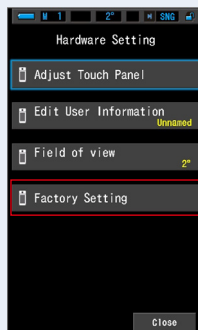

Factory Setting Screen

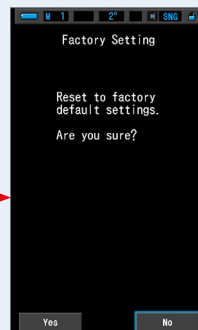

2. Touch the [Yes] button.

The factory setting confirmation message "All measurements will be lost when you perform this operation. Are you sure?" will be displayed.

Confirm again.

To return to the Hardware Setting screen without resetting to factory default settings, touch the [No] button.

Factory Setting Confirmation Screen

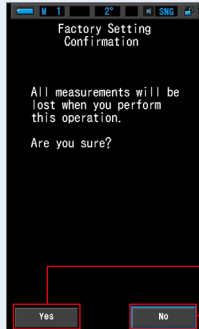

[Yes] Button

[No] Button

3. Touch the [Yes] button.



- When the message "Deleting Memory. Please wait." or the progress bar is displayed, do not turn the power off.

All measurement values are deleted, and returns to the Hardware Setting screen. (English display is the default factory setting.)

Factory Setting (Deleting) Screen Hardware Setting Screen

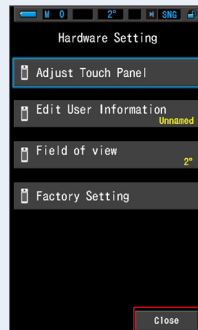

[Close] Button

4. Touch the [Close] button.

The Language Selection screen is displayed. Select the language to use. (→ P6)

Language Selection Screen



Language Selection Confirmation Screen

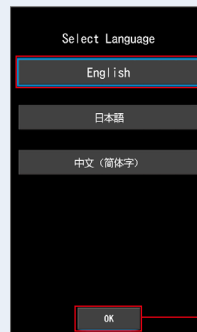

The selected button will be displayed encircled in blue.

[OK] Button

5. Press the [OK] to select the language.

The language can be switched at any time.

6. Dark calibration.

“Dark calibration in progress. Please wait” and the status bar will appear while calibrating. The Display Mode Selection screen will appear when operational.

Measuring Mode Selection Screen
page 1

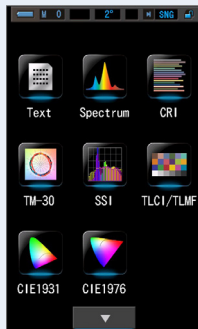

Factory setting is completed.

9. Appendix

9-1

Glossary

Term	Description
Color Temperature	<p>Color temperature refers to the chromaticity of a heated object (commonly refer to as a black body) that will vary according to its temperature. The color temperature is measured in units of Kelvin (K) and refers to the temperature of a heated object at a given color or chromaticity.</p> <p>The higher color temperature is, the bluer the light, and the larger the Kelvin value becomes. The lower the color temperature is, the redder the light, and the smaller the Kelvin value becomes.</p> <p>A figure that plots the changes of color temperatures on an xy chromaticity diagram is called the black body radiation locus.</p>
Correlated Color Temperature	<p>Not all light sources match the black body radiation locus when measuring light sources. In this case, the correlated color temperature is used. The correlated color temperature is a color temperature obtained by drawing an isothermperature line from the black body radiation locus which matches the measured value.</p>
Light	<p>This refers to the electromagnetic wavelength ranging from 380nm to 780nm that can be detected by the human eye.</p>
Black Body	<p>Theoretically, this is an object that absorbs all wavelengths and when heated, emits light equivalent to the applied color temperature.</p>
Black-body Radiation	<p>This refers to the light emitted by a black body.</p> <p>The amount of energy released for each wavelength changes with the applied color temperature, resulting in visible color variations.</p>
K	<p>Expressed in absolute Kelvin temperature, with units of "K". 0 (zero) K is equivalent to -273.15 °C or -459.67 °F.</p>
Δuv	<p>The deviation between the correlated color temperature and the black body radiation locus.</p> <p>When the correlated color temperature is above the black body radiation locus, a "+" sign is assigned; when below, a "-" sign is assigned.</p>
CRI (Color Rendering Index)	<p>Quantifies the faithfulness of color appearance under a measured light source as compared to the color appearance under a standard light source. Differences are expressed for individual hues, R1-R15, or as an average (Ra) of values R1 through R8.</p>
TM-30	<p>Technical Memorandum TM-30 is, published by Illuminating Engineering Society (IES), the method for evaluating light source color rendition including LED lights. The C-7000 with latest firmware shows TM-30-18 which Rf is identical with Rf of CIE 224:2017.</p> <p>The values are based on color appearance of objects with 99 color samples compared to their appearance under the defined reference illuminant.</p> <p>In the TM-30, there are Fidelity Index (Rf) which is to express how the accurate rendition of color is, and Gamut Index (Rg) to express what the average level of saturation is.</p>

Term	Description
SSI	Spectral Similarity Index (SSI) is, defined by Academy of Motion Picture Arts and Sciences, Science and Technical Council, the method to express how close a test spectrum is to a reference spectrum. It is the index (SSI) to evaluate the similarity of spectrum of two light sources.
TLCI-2012	Television Lighting Consistency Index (TLCI), developed by EBU (European Broadcasting Union), the method to evaluate the color rendition (the color appearance of objects) under the reference light source with 18 color samples and a mathematical model of a broadcast camera to 'see' the colors. TLCI is suitable index to the evaluation of television lighting equipment.
TLMF-2013	Television Luminaire Matching Factor (TLMF) is, developed by EBU (European Broadcasting Union), a new companion metric to TLCI, TLMF allows you to compare two different lights to each other, rather than to a perfect reference, and see if they will play well together. TLMF is suitable index to the evaluation of television lighting equipment.
CIE1931	This is the trichromatic system based on the color matching function, $\bar{x}(\lambda)$, $\bar{y}(\lambda)$, and $\bar{z}(\lambda)$ that has been adopted by the CIE in 1931. (This is also called the XYZ color system that has a 2° viewing angle.) It is applied when the field of view is 4° or less.
CIE1964	This is the trichromatic system based on the color matching function, $\bar{x}_{10}(\lambda)$, $\bar{y}_{10}(\lambda)$, and $\bar{z}_{10}(\lambda)$, which has been adopted by the CIE in 1964. (This is also called the XYZ color system that has a 10° viewing angle.) It is applied if the field of view exceeds 4°.
CIE1976	This chromaticity diagram features a scale so that the sense of difference of colors with the same illuminance becomes proportional to the geometric distance on the diagram at all points of the chromaticity diagram, which was determined by the CIE in 1976. This is calculated by the formula based on tristimulus values X, Y and Z or chromaticity coordinates x and y of XYZ color system.
Field of View	CIE standard observers help correlate instrumental color measurements to human visual assessments. The 2 degree field of view is common within quality control and other color evaluation procedures, particularly for food applications. The 10 degree field of view is considered to be more representative of how the human eye is commonly used with spectrophotometers for formulating and evaluating the color of various types of samples.
Photosynthetic Photon Flux Density	The photosynthetic photon flux density is the Photon is that the number of incident per unit time and unit area, needed for photosynthesis at a wavelength from 400nm to 700nm. The unit represent in $\mu\text{mol m}^{-2}\text{s}^{-1}$.

9-2

Specifications

Type

- Spectrometer with CMOS linear image sensor

Illuminance meter class

- Conforms to JIS C 1609-1:2006 for General Class A Illuminance Meters
- Conforms to DIN 5032 Part 7 Class C

Light receiving method

- Incident light

Light receptor

- White diffuser (fixed type)

Light receptor element

- CMOS linear image sensor 128 pixels

Measurement system

- | | | |
|--|--|---|
| <ul style="list-style-type: none"> • Measuring mode | <ul style="list-style-type: none"> • Ambient light • Flash light | <ul style="list-style-type: none"> Ambient light mode Cord (PC) Flash mode Cordless Flash mode |
| <ul style="list-style-type: none"> • Display mode | | <ul style="list-style-type: none"> Text mode, Spectrum mode, Spectrum Comparison mode, CRI mode, CRI Comparison mode, TM-30 mode, SSI mode, TLCI/TLMF mode, CIE1931 (CIE1964) mode, CIE1931 (CIE1964) Comparison mode, CIE1976 mode, CIE1976 Comparison mode |

Measuring item

- | | |
|---|--|
| <ul style="list-style-type: none"> • T_{cp} • Δuv • $X, Y, Z / X_{10}, Y_{10}, Z_{10}$ • $x, y, z / x_{10}, y_{10}, z_{10}$ • $u', v' / u'_{10}, v'_{10}$ • $\lambda_d / \lambda_{d,10}$ • $P_e / P_{e,10}$ • λ_p • Lux, fc / Hlx, Hfc • Ra • R1 ~ R15 • Rf, Rg • SSlt, SSld • TLCI • TLMF • PPFd | <ul style="list-style-type: none"> Correlated Color temperature Deviation Tristimulus value CIE1931(CIE1964)Chromaticity coordinates CIE1976 Uniform Chromaticity Scale Dominant wavelength Excitation purity Peak wavelength Illuminance / luminous exposure Average Color Rendering Index Special Color Rendering Index Photosynthetic Photon Flux Density |
|---|--|

Measurement range

• Illuminance	• Ambient light	1lx to 200,000lx 0.1fc to 18,600fc
• Luminous exposure	• Flash light	Range L: 20lx·s to 640lx·s (f/2.8 to f/16) Range H: 580lx·s to 20,500lx·s (f/11.9 to f/90)
• Photosynthetic Photon Flux Density		0.0 to 9999.9 $\mu\text{mol m}^{-2}\text{s}^{-1}$
• Color rendering properties	• CRI	Ra, R1 to R15 -100.0 to 100.0
	• TM-30	Rf 0 to 100 Rg 0 to 200
	• SSI	SSI 0 to 100
	• TLCI-2012	Qa 0 to 100
	• TLMF-2013	\angle Qa 0 to 100 (5lx to 200,000lx = 0.46fc to 18,600fc)

Accuracy

• Illuminance	$\pm 5\%$ ± 1 digit of indicated value (Complies with JIS C1609-1:2006 general A class illuminometer)
• x y	± 0.003 (Light source A, 800lx)

Repeatability (2σ)

• Illuminance	1% + 1digit (Light source A, 30lx to 200,000lx), 5% + 1digit (Light source A, 1lx to 29.9lx)
• x y	• 0.001 (Light source A, 500lx to 200,000lx) • 0.002 (Light source A, 100lx to 499lx) • 0.004 (Light source A, 30lx to 99lx) • 0.008 (Light source A, 5lx to 29.9lx)

Spectral response characteristics

• f1'	9% or less (Complies with JIS C1609-1:2006 general A class illuminometer)
-------	---

Oblique incident light characteristics

• f2	6% or less (Complies with JIS C1609-1:2006 general A class illuminometer)
------	---

Temperature characteristics

• Illuminance	$\pm 5\%$ of indicated value (Complies with JIS C1609-1:2006 general A class illuminometer)
• x y	± 0.006 (Light source A, 1000lx)

Humidity characteristics

• Illuminance	$\pm 3\%$ of indicated value (Complies with JIS C1609-1:2006 general A class illuminometer)
• x y	± 0.006 (Light source A, 1000lx)

Display range

• Color temperature		1,563K to 100,000K (5lx to 200,000lx)
• Illuminance	• Ambient light	1lx to 200,000lx (3 significant digits)
• Luminous exposure	• Flash light	20 lx·s to 20,500 lx·s, 1.86 fc·s to 1,900 fc·s (3 significant digits)
• Shutter speed	• Flash light	1 second to 1/500 second
• Color rendering properties	• CRI	Ra, R1 to R15 -100.0 to 100.0
	• TM-30	Rf 0 to 100 Rg 0 to 200
	• SSI	SSI 0 to 100
	• TLCI-2012	Qa 0 to 100
	• TLMF-2013	∠ Qa 0 to 100 (5lx to 200,000lx = 0.46fc to 18,600fc)

Other functions

• Preset setting	• Preset 1 to 5 settings
• Setting	• 6 item settings
• Memory function	• Up to 999 measurements or titles
• Memory clear/recall function	
• Out of measurement range or out of display range	• [Under]/[Over] warning display
• Battery capacity indicator display	• With 4 level status icons
• Automatic power OFF function	• Time elapsed after last operation: selectable from 20min., 10min., 5min., none
• LCD backlight	• Brightness can be selected from bright, normal, or dark • Dimmer time after last operation: selectable from about 5second, about 10second, about 20second, about 40second, about 60second, none
• Touch panel lock function	Hold MENU button 6 down for 3 seconds to lock and unlock.
• Tripod socket	• 1/4-inch, 20 threads

Display

• LCD display resolution	• 4.3 inch QVGA 480×800 dots
--------------------------	------------------------------

Recommended battery

• AA batteries	• 1.5V × 2 alkaline, manganese
----------------	--------------------------------

Power Supply

• USB bus-power	• 5V/500mA or less (via USB cable when connected to computer) • (Limited Power Source or Class 2 Power Source)
-----------------	---

Operating temperature

- -10°C to 40°C (without condensation)

Operating humidity

- 85%RH or less (at 35°C) (without condensation)

Transportation and storage conditions

- -10°C to 60°C (without condensation)

Dimensions

- Approx. 73 (width) × 183 (height) × 27 (depth) mm
(excluding protruding part of light receiving) (max. thickness 40mm)

Weight

- approx. 230g (without batteries)

Included accessories

- CD-ROM (this Operating Manual and applications (Win, Mac)), Soft case, Strap, Start-up Guide, Safety Precaution, Safety Requirement and Precaution, USB Cable (Mini-B connector)

* Models sold in some countries do not display illuminance and exposure in "fc (fc·s)" due to legal restrictions. In this case, Unit of Illuminance is not displayed.

* Specifications and appearance described in this Operating Manual are subject to change without prior notice for improvement.

Measurement Reference Plane

- Tip of the Light Receiving Part

Color correction factor of the general illuminating light source against the CIE standard illuminant A: C-7000

Light source	Color correction factor
supplementary standard illuminant B	0.984
supplementary standard illuminant C	0.978
CIE standard illuminant D ₆₅	0.977
Fluorescent lamp F6	0.995
Fluorescent lamp F8	0.983
Fluorescent lamp F10	0.983
High-pressure sodium lamp	1.022
Metal halide lamp H1	0.978
Metal halide lamp H2	0.992
High-pressure mercury lamp	0.990

In the relative spectral responsivity characteristics of C-7000, error value from the standard spectral luminous efficiency $V(\lambda)$ is small (f_1' : 9% or less). Therefore, when using for ordinary purposes, correction based on the color correction factor is not necessary.

Distance range in which the Inverse Square Law is in effect

- 50 cm or more from the measurement reference plane



Incident Uniformity

- This device is assumed to be used under the condition that the light receiving surface is completely covered by an almost uniform light in illuminance distribution. An error may occur in the case of highly directional light source or an uneven light distribution characteristic.

9-3 Legal Requirement

■ Legal Requirement

This product complies with the following legal requirements.

Destination	Standard		Details
Europe	CE 	SAFETY	IEC (EN) 61010-1
		EMC	EMC: EN61326-1
		Environmental	WEEE
			RoHS
			REACH
North America	FCC (US) 	EMC	FCC Part15 SubpartB ClassA
	IC (Canada)	EMC	ICES-003
Japan	Environmental		Containers and Packaging Recycling Law
China	Environmental		China RoHS
South Korea	KC	EMC	KN11 KN61000-6-1
		1. 기자재의명칭 (모델명) : COLOR METER (C-7000) 2. 식별부호 : MSIP-REM-SK0-C-700 3. 상호명 : SEKONIC CORPORATION 4. 제조자 : SEKONIC CORPORATION 5. 제조국가 : 일본	

10. Optional Accessories

■ Synchro Cord

This is a five-meter (16.4 feet) long cord with three plugs.

An exposure meter, a camera and a flash can all be connected at the same time without having to plug or unplug the cord during shooting. Also, the connection terminal (male) on the light meter side of the synchro cord has a locking mechanism to ensure it remains connected to the meter.

(1 male terminal on the light meter side, 1 male terminal and 1 female terminal)

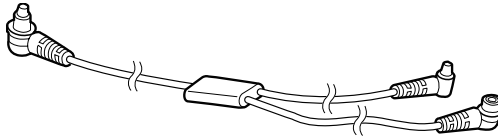

11. Troubleshooting

The following cases may not suggest failures. Please check again before requesting repair. When the meter does not function normally after checking the following, it may be damaged. Remove the battery, and ask the retailer or us to repair it.

Status	Check item	Measure
It does not turn on (It does not display)	Are you pressing and holding the Power Button for one or more seconds?	Press and hold the Power Button for one or more seconds.
	Are $\oplus \ominus$ of the batteries inserted properly?	Check the $\oplus \ominus$ signs. (➔ P4)
	Are the batteries exhausted?	Replace the batteries. (➔ P10)
	Are the battery terminals dirty?	Wipe them off with a dry cloth.
	Are you using the specified batteries?	Check the batteries. (➔ P4)
The LCD does not respond	Is the screen locked?	Press and hold the Menu Button 6 to unlock the screen. (➔ P20)
The measurement cannot be made	Are you using the "C-700/C-7000 Series Utility"?	Stop using the "C-700/C-7000 Series Utility".
The measured values are wrong	Is the Light Selection Ring in the middle position? The light distribution characteristics change and suitable measurements cannot be made.	Rotate the Light Selection Ring until it clicks.
	Is the measuring mode wrong? (Such as measuring in Ambient Light Mode in flash light)	Check if the measuring mode is correct. (➔ P23)
	Are you using the pre-flash function when measuring in Cordless Flash Mode?	In Cordless Flash Mode, the measurement value of the main flash may not be displayed because the pre-flash is measured at first. Cancel the pre-flash function.

Status	Check item	Measure
The memory function cannot be used	Is the differential measurement icon displayed?	The memory function cannot be used when the differential measurement icon is displayed. Cancel the differential measurement mode.
	Is "Memory Full" displayed when pressing the Memory Button?	The memory can store up to 999 values. Clear unnecessary memory values in advance, measure, and memorize it.

12. After-sales Services

- Contact your local distributor or camera store that you purchased from for warranty and service.
- Even within the warranty period, repair services may be provided on a paid basis.

Check the conditions of warranty provided by local distributor or retailer.

- The warranty is not valid unless the copy of proof of purchase with the date of purchase and the retailer name. Be sure to store such information (bill of purchase or receipt) in a safe location.
- We will retain performance parts for repairs for approximately seven years after production is discontinued. Therefore, we may not be able to carry out repairs after this period has elapsed.
- When requesting repairs, please provide us with as much detail as possible about the failure or specific failure locations that you are able to identify. In certain cases, some products that are returned to us for repairs are not malfunctioning, and begin to operate normally again when we simply replace the batteries. Before requesting repairs, please confirm that the batteries are installed in the correct polarities, contain sufficient charge, and that they match the rating.

FCC & IC compliance information

This equipment has been tested and found to comply with the limits for a Class B digital device, pursuant to Part 15 of the FCC Rules. These limits are designed to provide reasonable protection against harmful interference in a residential installation. This equipment generates, uses and can radiate radio frequency energy and, if not installed and used in accordance with the instruction, may cause harmful interference to radio communications.

However, there is no guarantee that interference will not occur in a particular installation. If this equipment does cause harmful interference to radio or television reception, which can be determine by turning the equipment off and on, the user is encouraged to try to correct the interference by one or more of the following measures:

- Reorient or relocate the receiving antenna.
- Increase the separation between the equipment and receiver.
- Connect the equipment into an outlet on a circuit different from that to which the receiver is connected.
- Consult the dealer or an experienced radio/TV technician for help.

Caution: Any changes or modifications to this device not explicitly approved by manufacturer could void your authority to operate this equipment.

FCC Warning

This device complies with part 15 of the FCC Rules. Operation is subject to the following two conditions: (1) This device may not cause harmful interference, and (2) this device must accept any interference received, including interference that may cause undesired operation.

For Canada CAN ICES-003(B) / NMB-003 (B)

IC Warning

This device complies with Industry Canada licence-exempt RSS standard(s). Operation is subject to the following two conditions: (1) this device may not cause interference, and (2) this device must accept any interference, including interference that may cause undesired operation of the device.

Le présent appareil est conforme aux CNR d'Industrie Canada applicables aux appareils radio exempts de licence. L'exploitation est autorisée aux deux conditions suivantes :

(1) l'appareil ne doit pas produire de brouillage, et (2) l'utilisateur de l'appareil doit accepter tout brouillage radioélectrique subi, même si le brouillage est susceptible d'encompromettre le fonctionnement.

SEKONIC CORPORATION

7-24-14, Oizumi-Gakuen-Cho, Nerima-Ku, Tokyo
178-8686 Japan

TEL +81-3-3978-2335 FAX +81-3-3978-5229

<http://www.sekonic.com>