

VELVET Light 2 Studio IP51

Ref.: VL2ST

Datasheet: June 2021 / Page 1



Bicolor dustproof AC powered soft light LED panels

[Click here for more product information](#)

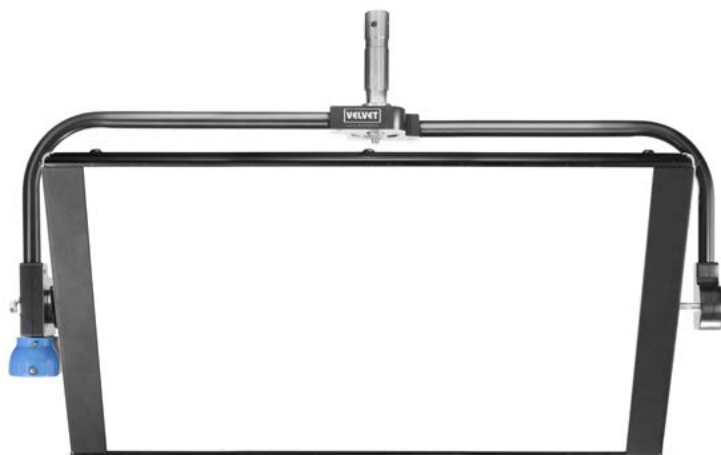

1. Power switch
2. XLR-3 DC In
3. XLR-5 DMX In
4. +/- Adjustment buttons
5. 3200K/ 5600K Quick access button
6. Mode selection button (Dimmer/ Colour Temp)
7. Digital display
8. XLR-5 DMX Out



VELVET Light 2 Studio IP51



Ref.: VL2ST

Datasheet: June 2021 / Page 2

COLOUR TEMPERATURE	adjustable from 2700K to 6500K in 100K steps
LIGHT INTENSITY	dimnable 0 to 100, smooth and flicker-free
TLCI	95 at 3200K and 95 at 5600K
DIMENSIONS	670x308x68mm (panel) / 770x435x68mm (panel+yoke)
WEIGHT	5.9 kg (panel) / 6.5 kg (panel + yoke)
POWER DRAW	150W
POWER SUPPLY	90-264V AC 50/60Hz
BEAM ANGLE	100°
PHOTOMETRICS	4000 lux / 370 fc at 1m / 3 feet 580 lux / 53 fc at 3m / 10 feet
LED RATED LIFE	more than 50,000 hours L70 more than 35,000 hours L80
POWER CONNECTION	Neutrik XLR-3 DC In connector
DMX	DMX-RDM with XLR-5 In & Out connectors
OUTPUT FREQUENCY	2000 fps
TEMPERATURE COOLING	from -20°C to +40°C no-noise, fan-free passive cooling
PROTECTION	IP51 dustproof, indoor or outdoor protected use
VELVET LED TECHNOLOGY	Selected BIN LED + optic diffuser + CPU software control
RIGGING OPTIONS	aluminum yoke with 16 female combined with 28 pin, quick link swivel ball head, pole operated yoke, multipanels yokes
QUICK MOUNTING ACCESSORIES	AC power supply, foldable Snapgrid, removable barn doors, cordura case, hard case
CONSTRUCTION & FINISH	Black anodized extruded aluminum and black powder coated sheet aluminum

WIRE VIEW

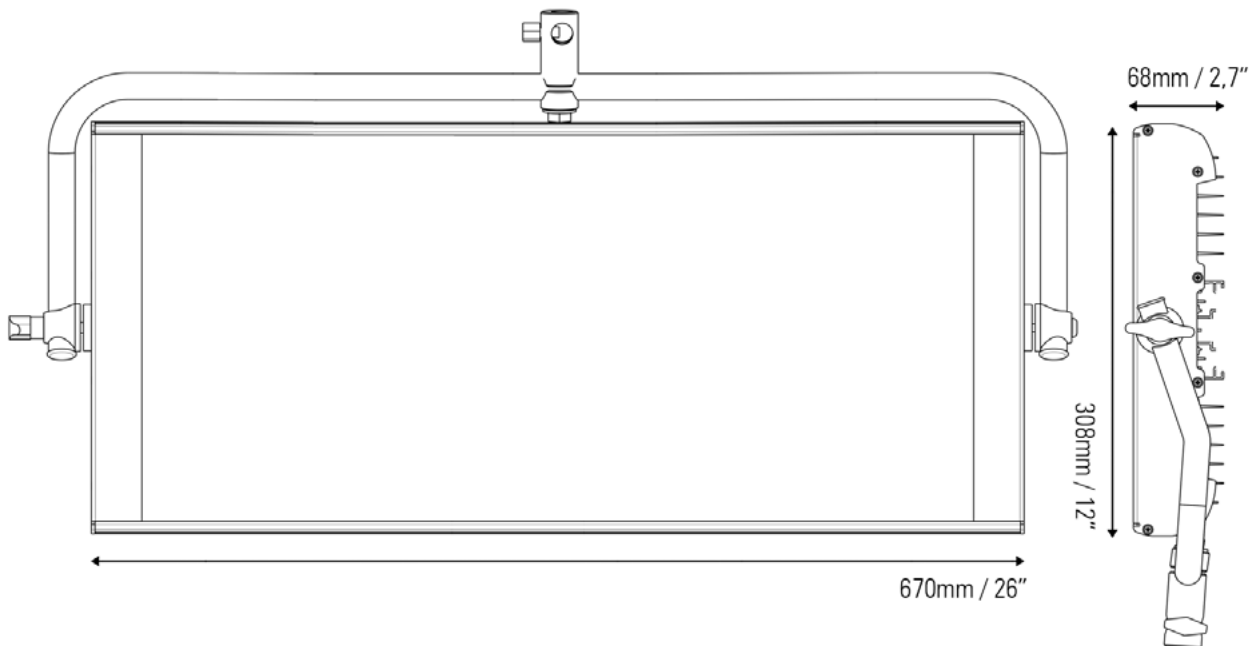

VELVET Light 2 Studio IP51



Ref.: VL2ST

Datasheet: June 2021 / Page 3

PHOTOMETRICS

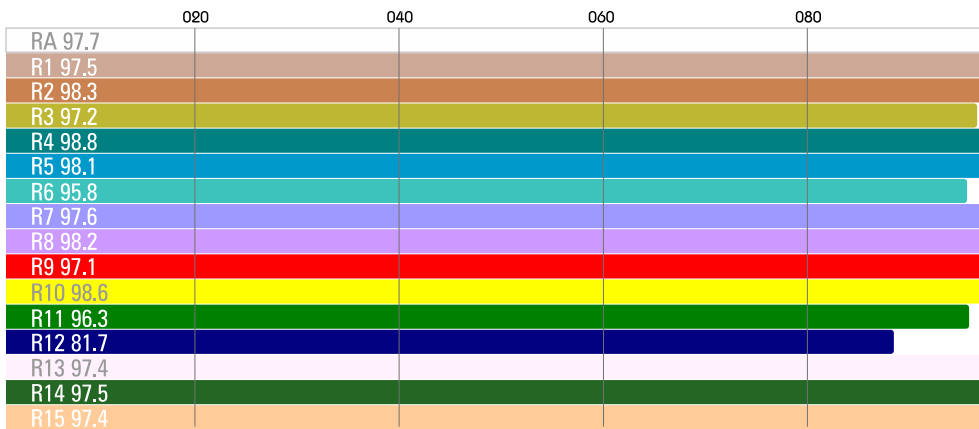
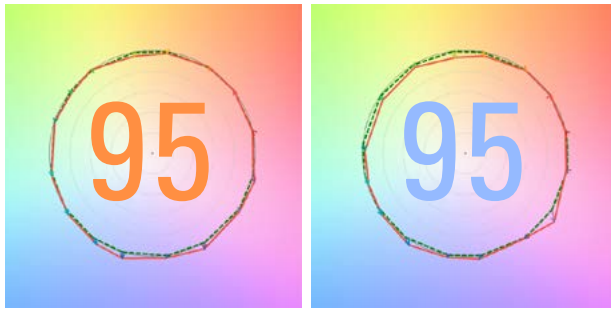
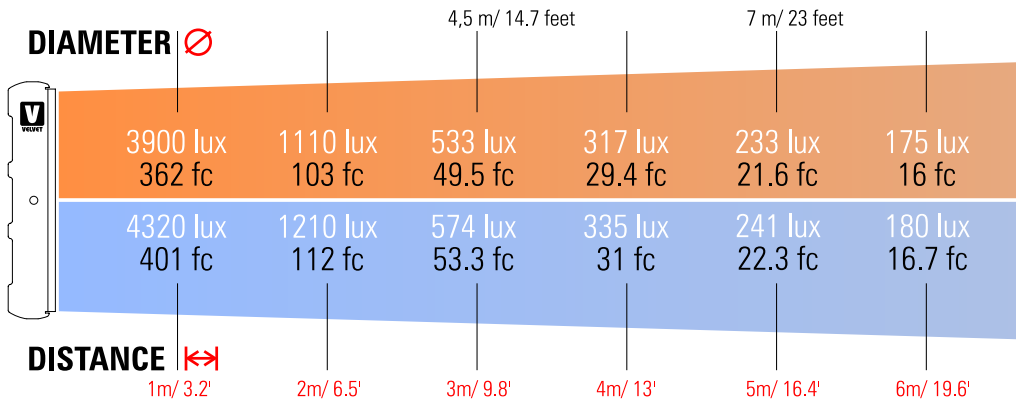

CCT 3270K

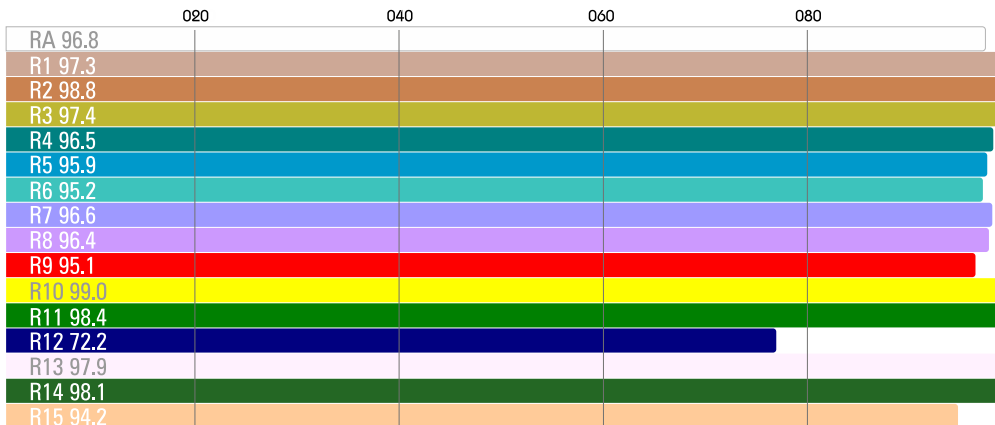

CCT 5740K













VELVET Light 2 Studio IP51

Ref.: VL2ST

Datasheet: June 2021 / Page 4



ACCESSORIES

POWER SUPPLY	RIGGING		REMOTE CONTROL
 VL2ST-PSU	 VL2-QLS	 VL2-YPO	 VL-RC
BEAM CONTROL			
 VL2-RB	 VL2-SG	 VL2-SG20	 VL2-SG60
TRANSPORT			
 VL2-SB	 VL2-SGXS	 VL2-BAG	 VL2-CASE